

8 mm.

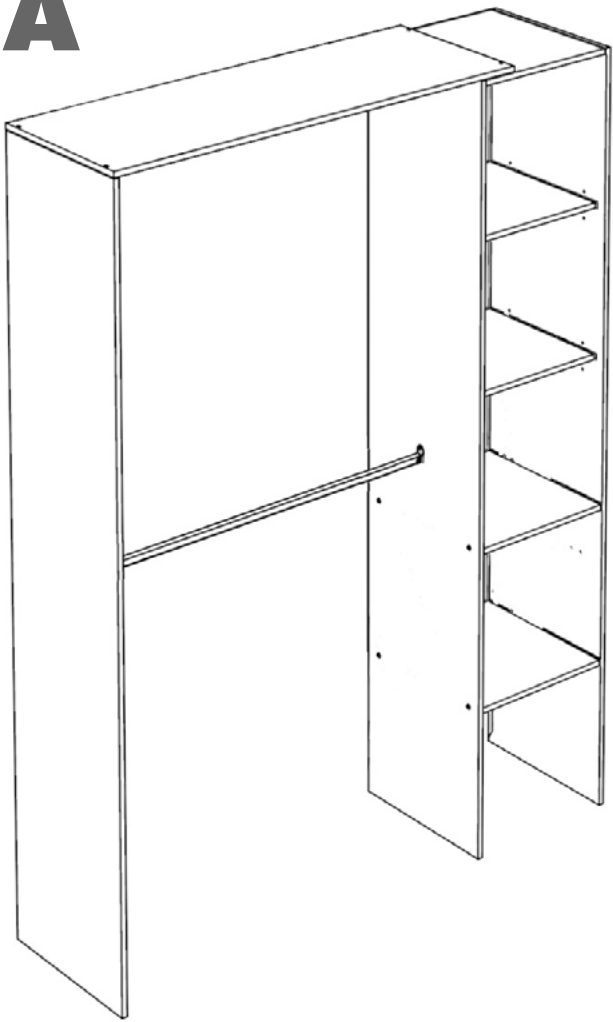

A



B

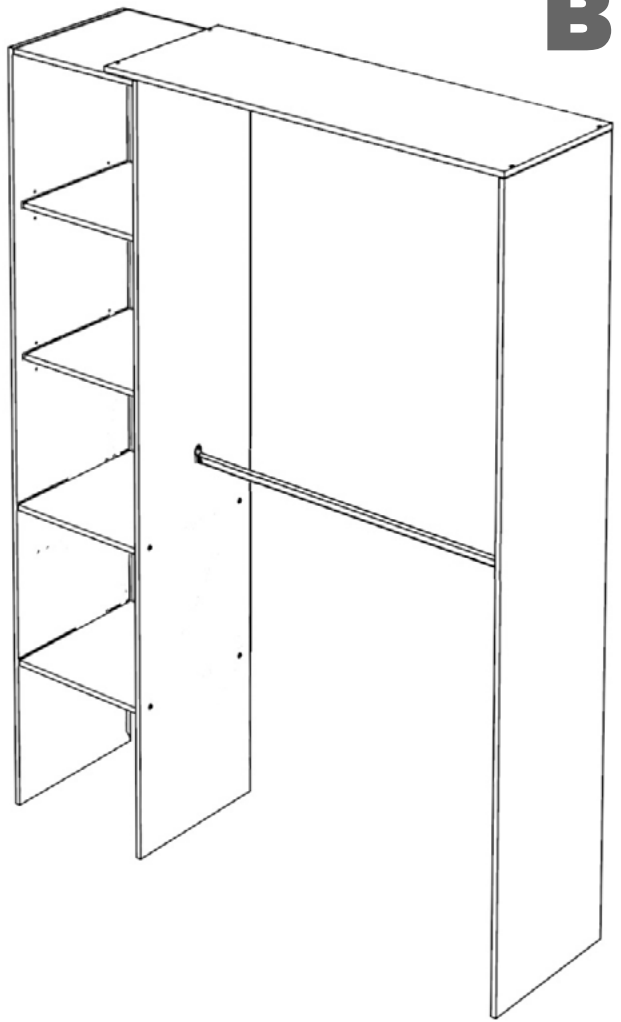

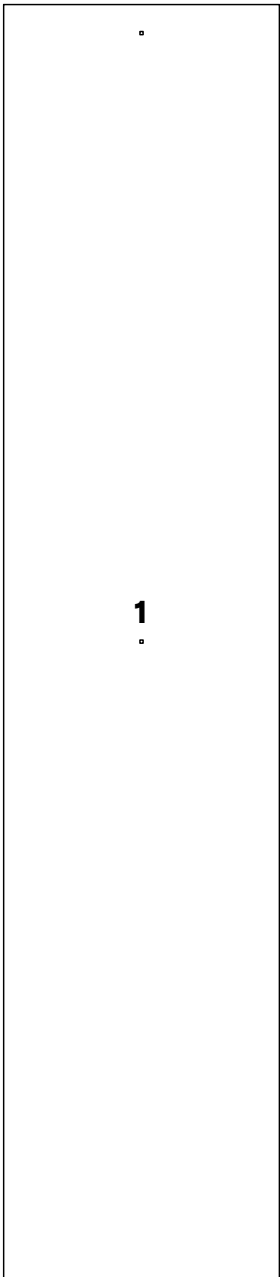

1

399 x 1850 mm.

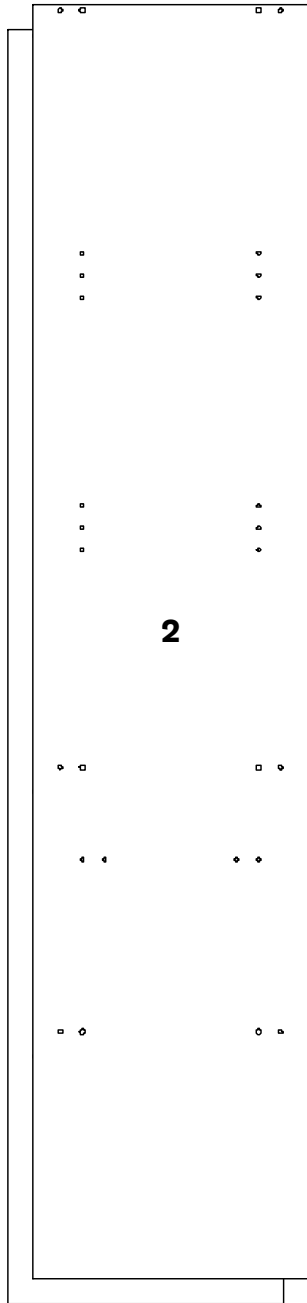

2

399 x 1850 mm.

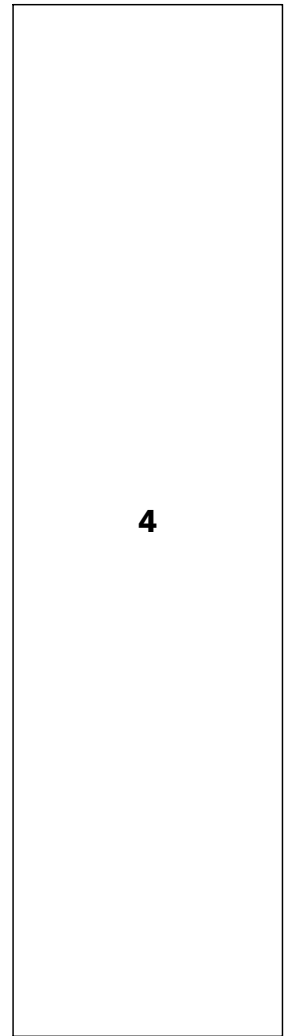

4

393 x 1499 mm.

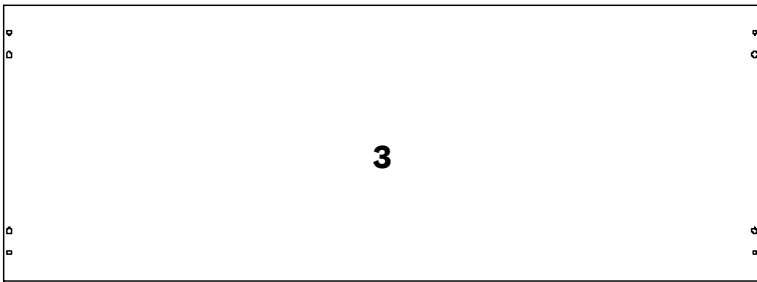

3

1100 x 400 mm.

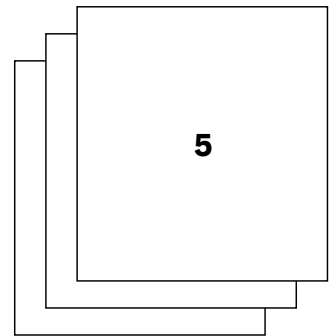

5

363 x 397 mm.

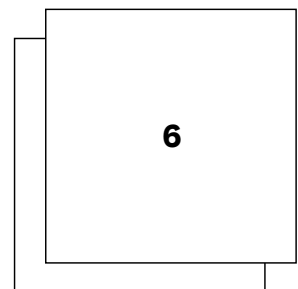

6

363 x 342 mm.

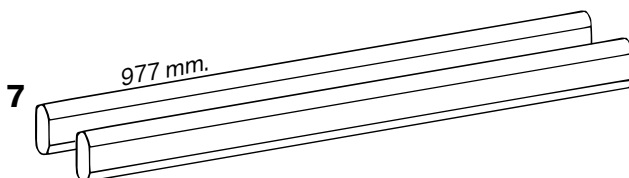

7

977 mm.

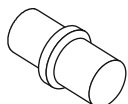

F x 08

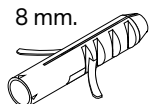

H x 02

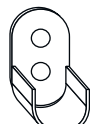

K x 04

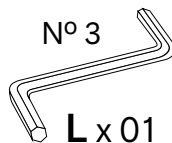

N° 3

L x 01

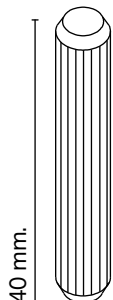

A x 14



G x 06

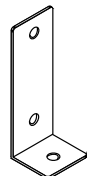

J x 02

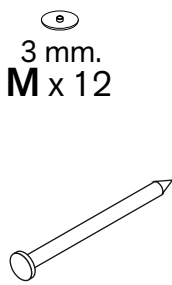

3 mm.
M x 12

I x 30

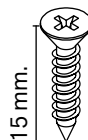

15 mm.
B x 10

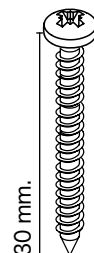

30 mm.
C x 02

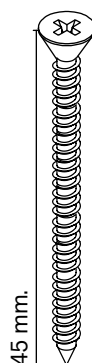

45 mm.
D x 02

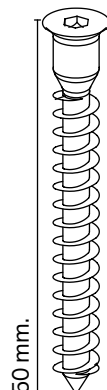

50 mm.
E x 14

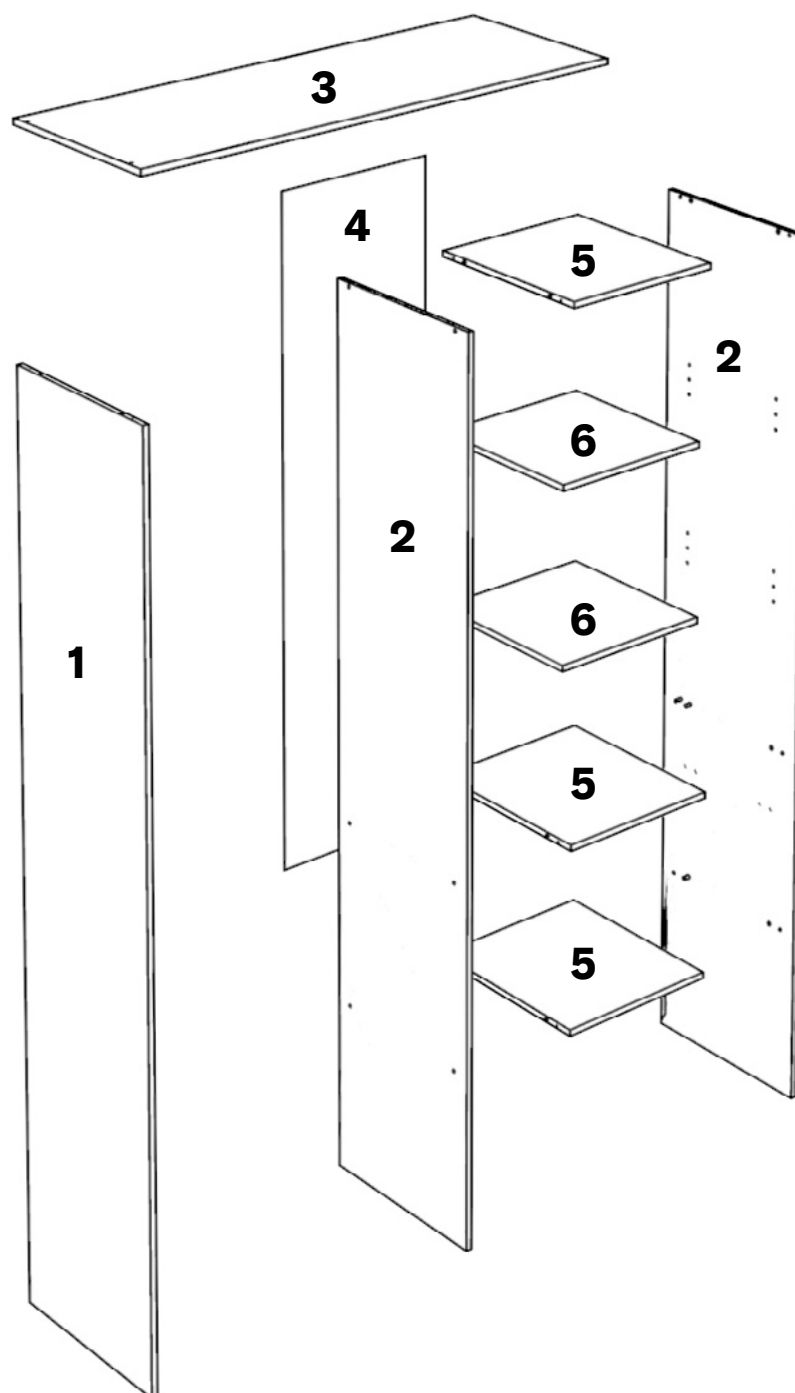

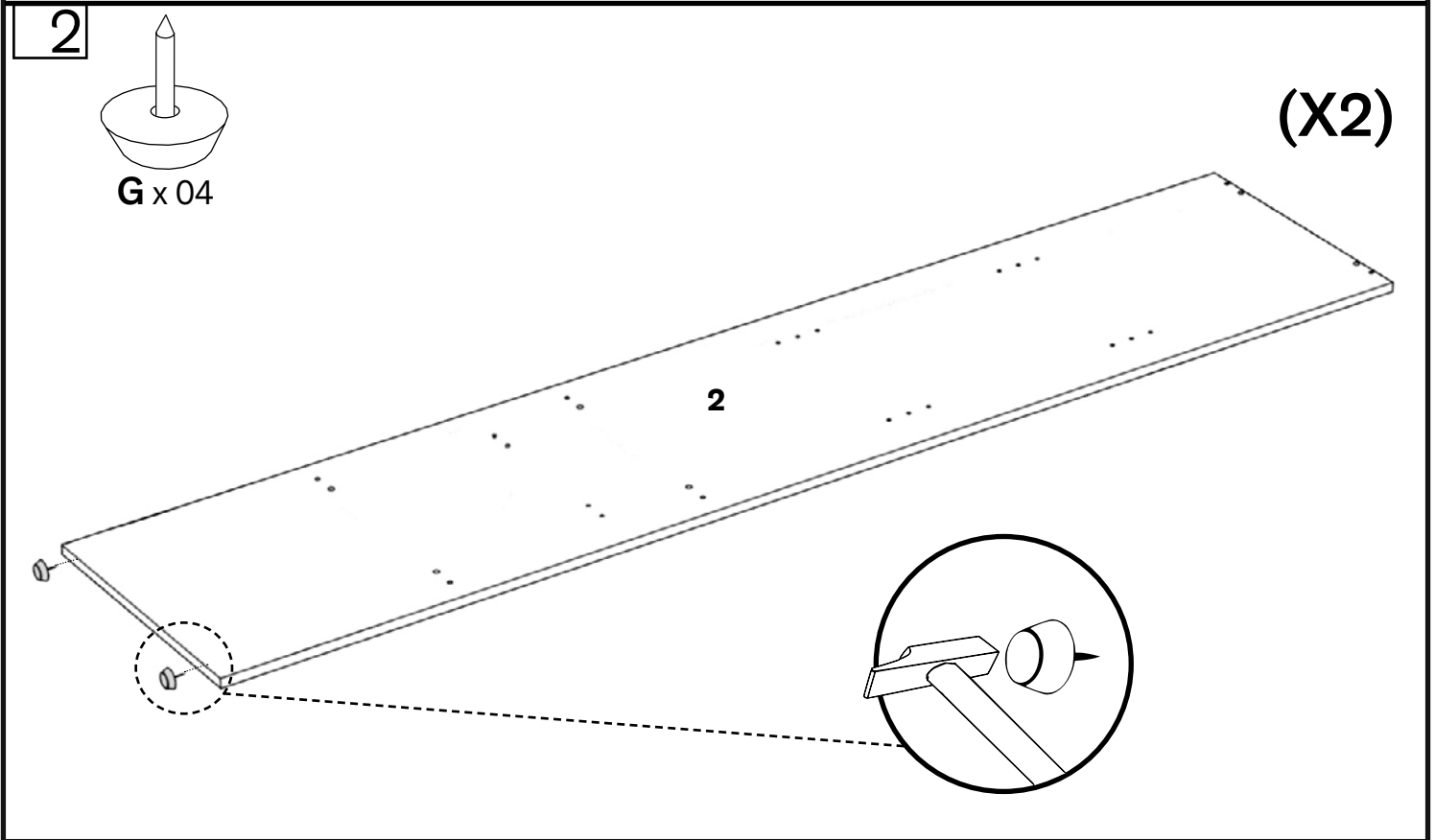
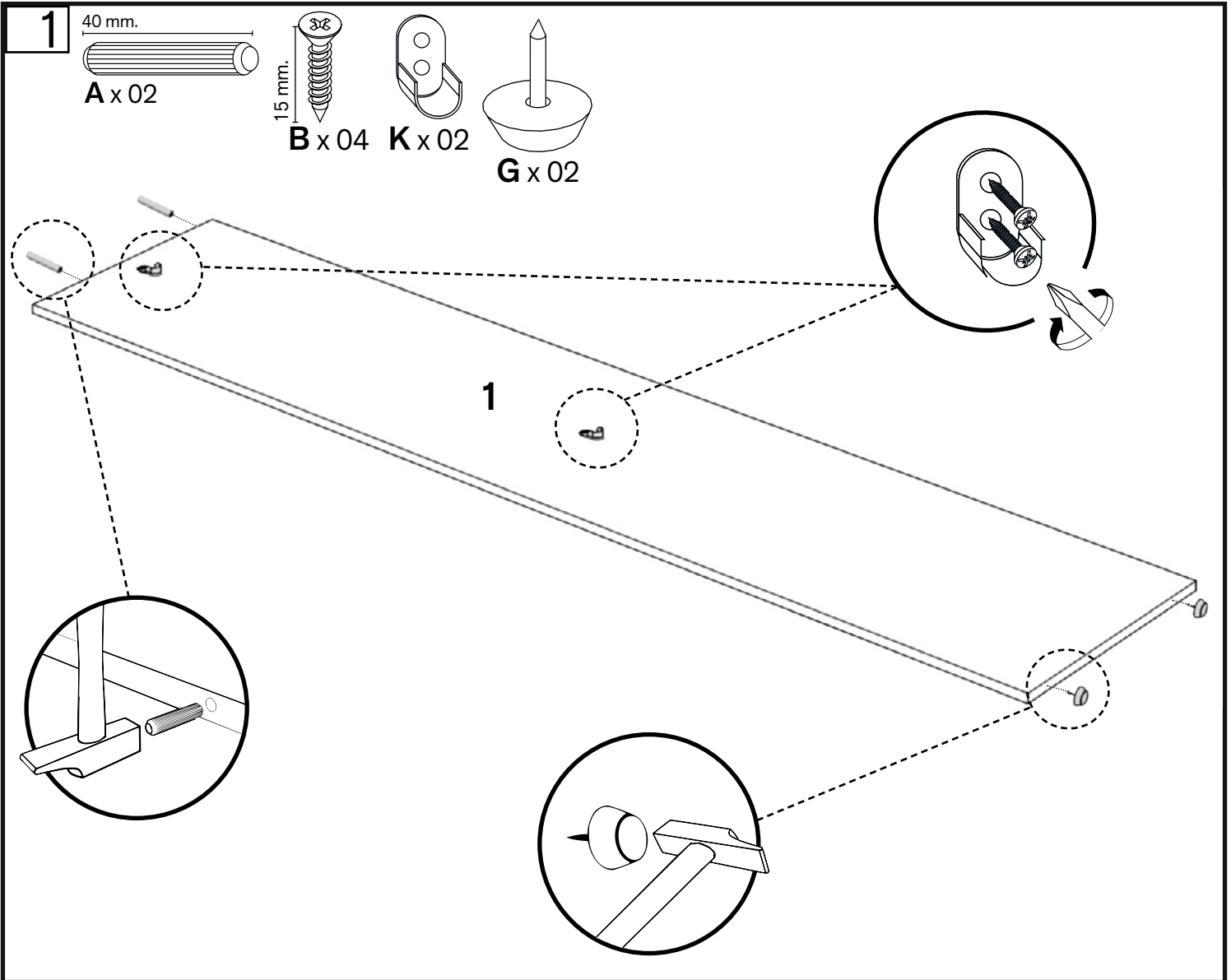

3

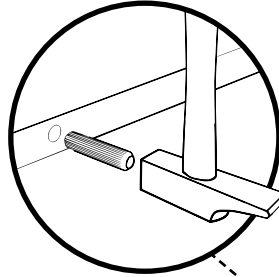
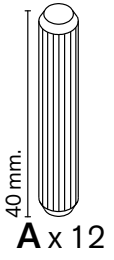

(X3)

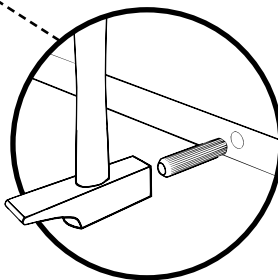
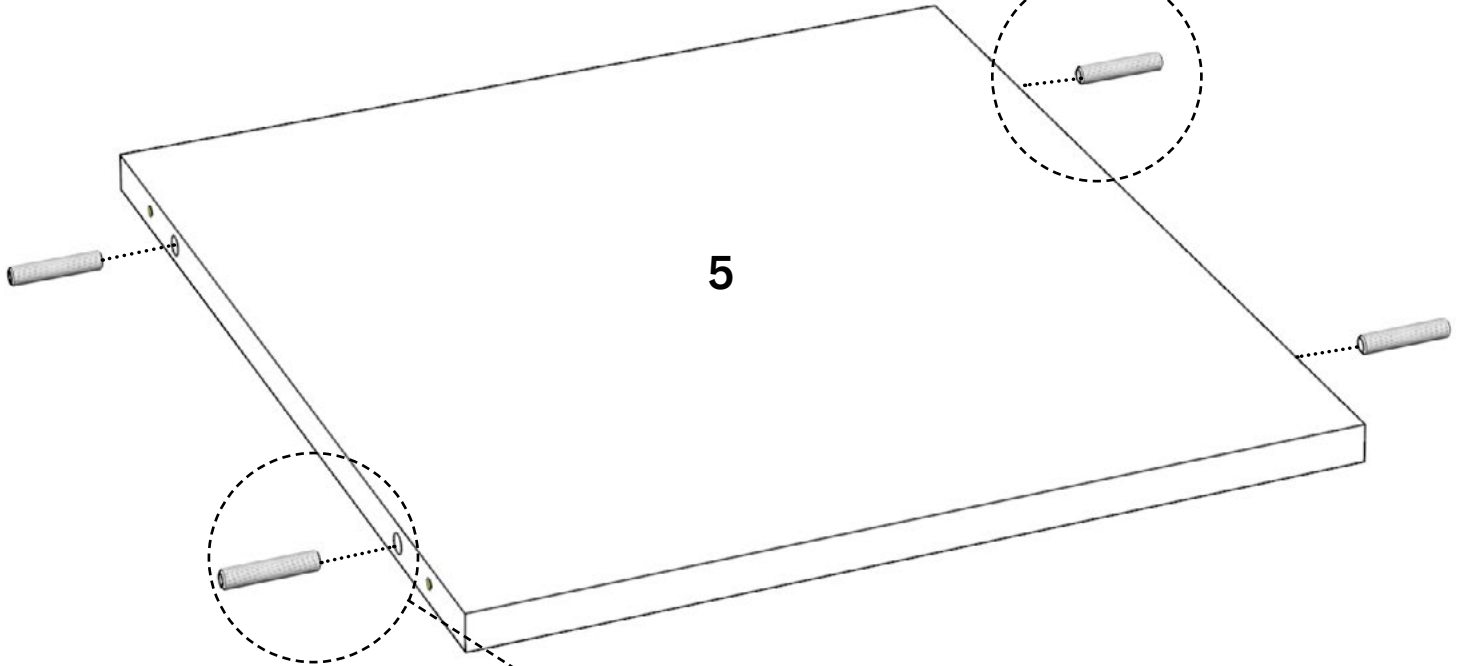

4

3 mm.
M x 12

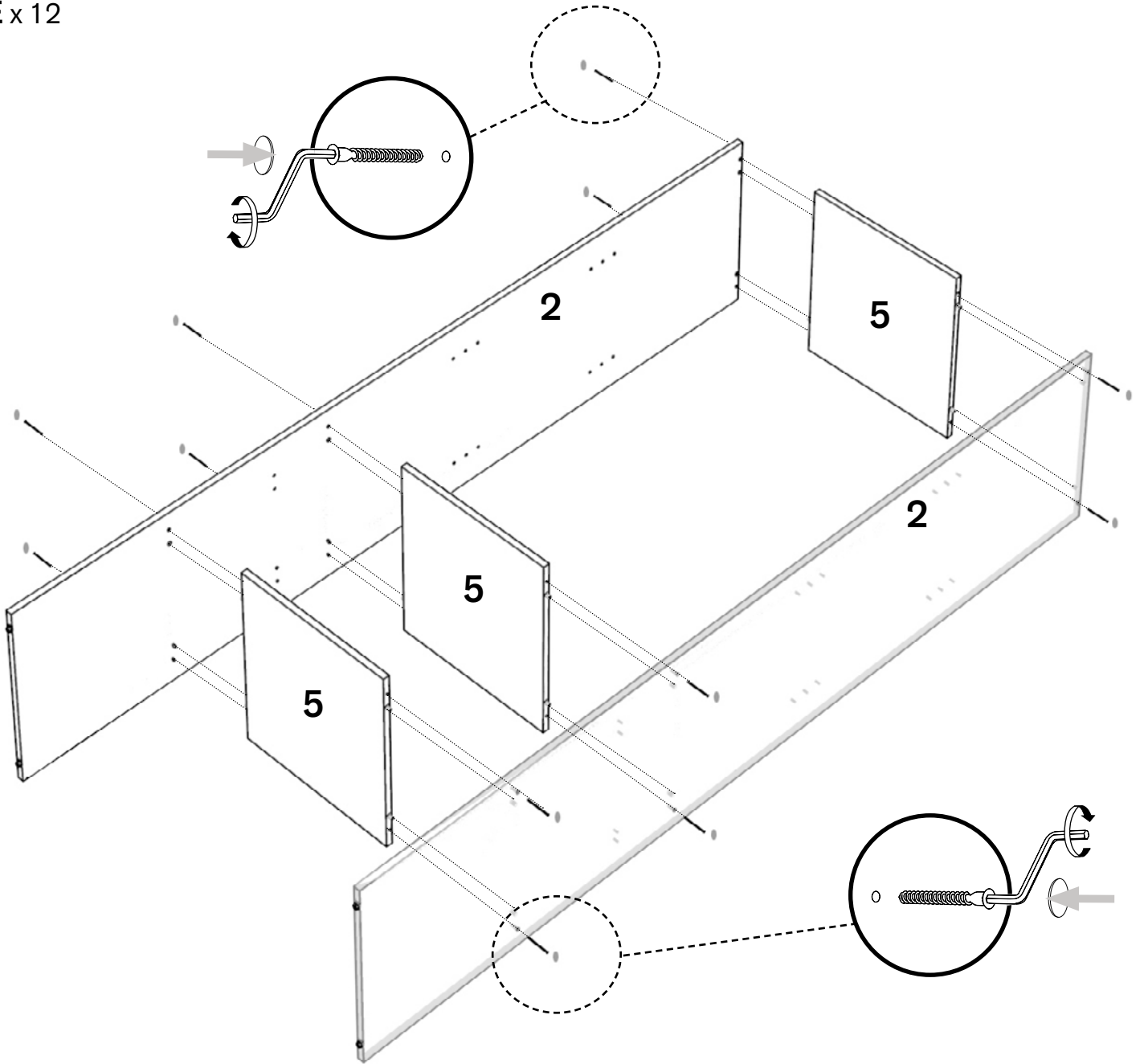
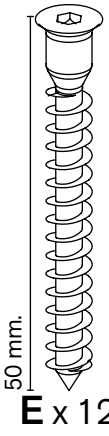

5

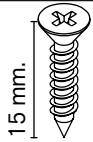

B x 04

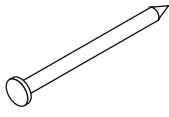

I x 30

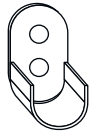

K x 02

A

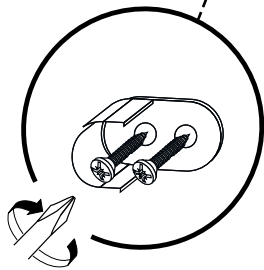
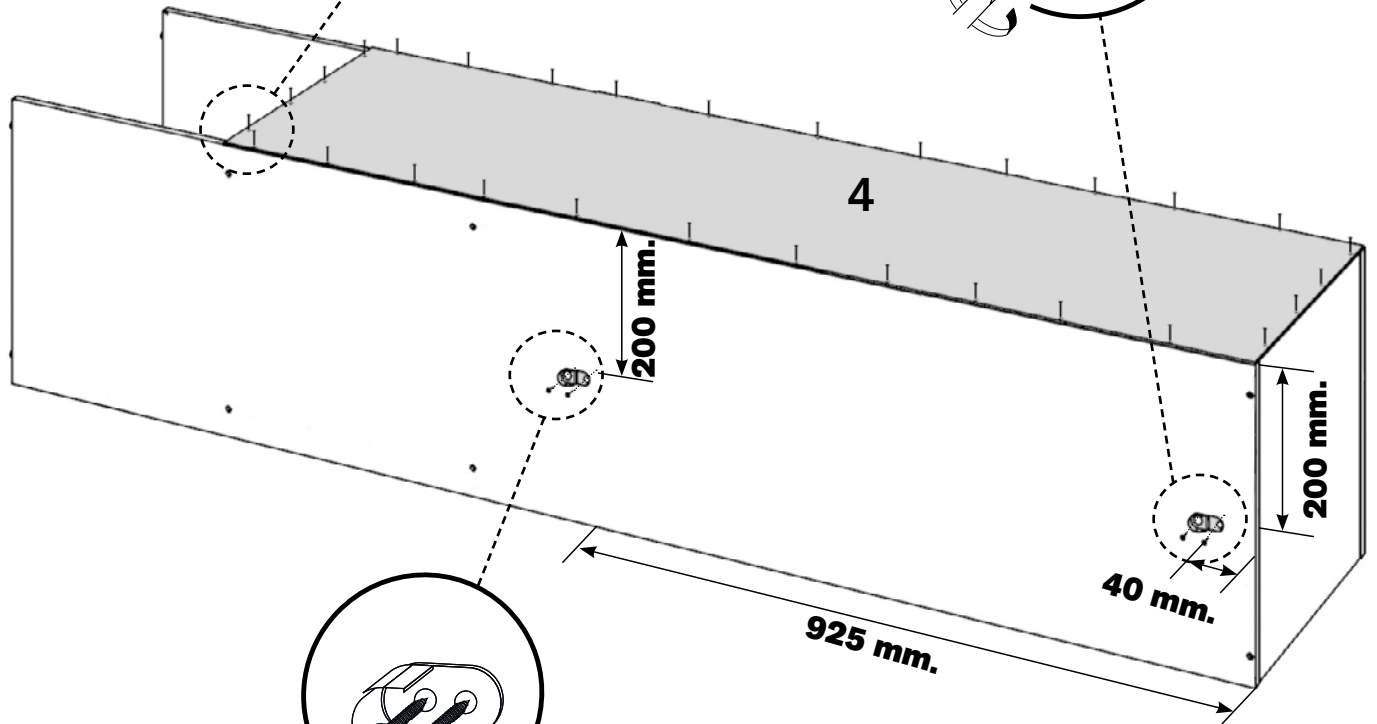
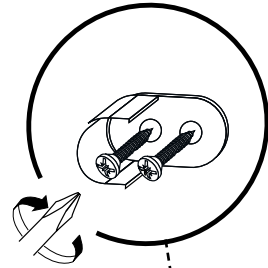
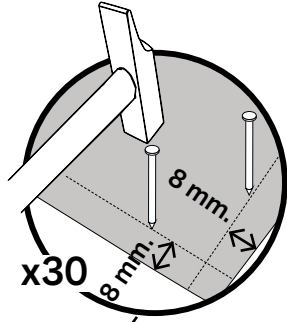
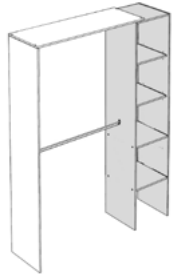

5

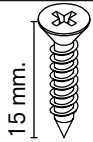

B x 04

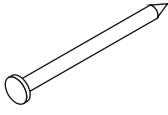

I x 30

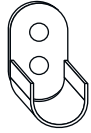

K x 02

B

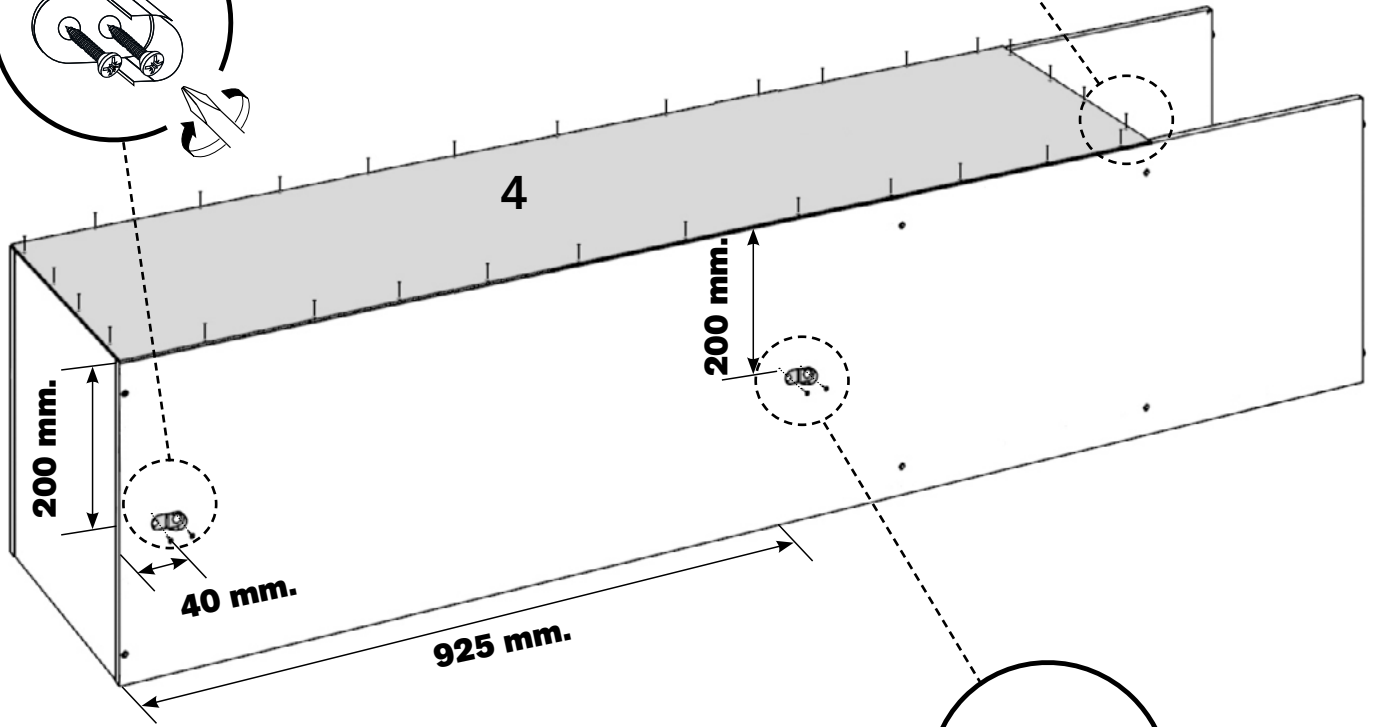
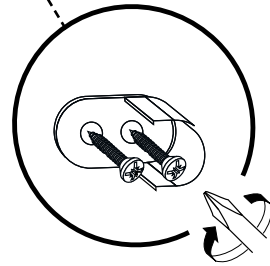
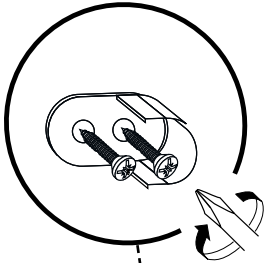
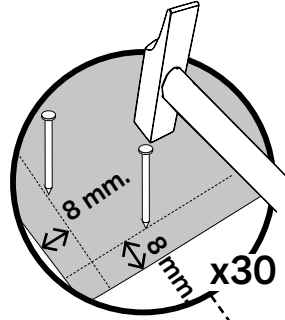
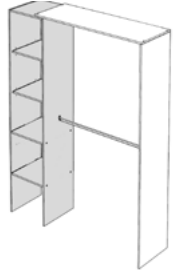

6

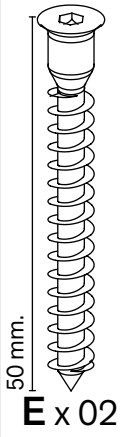

A

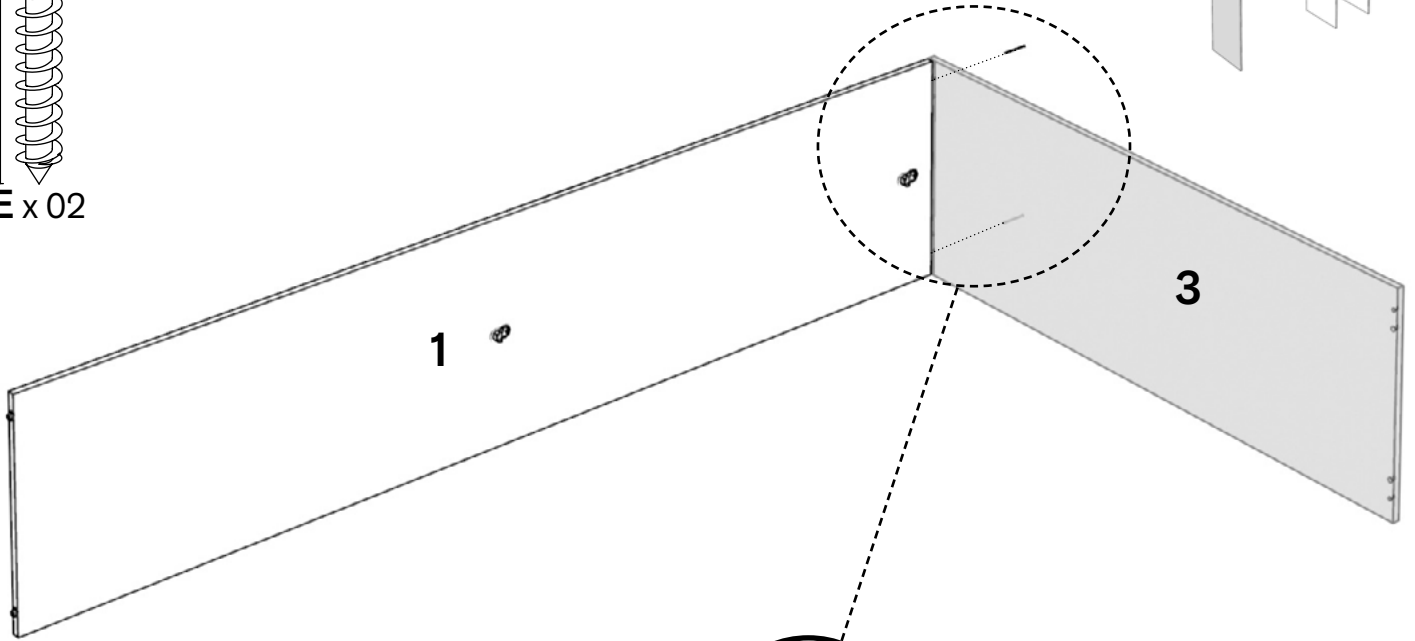
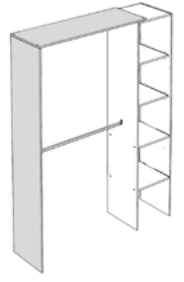

B

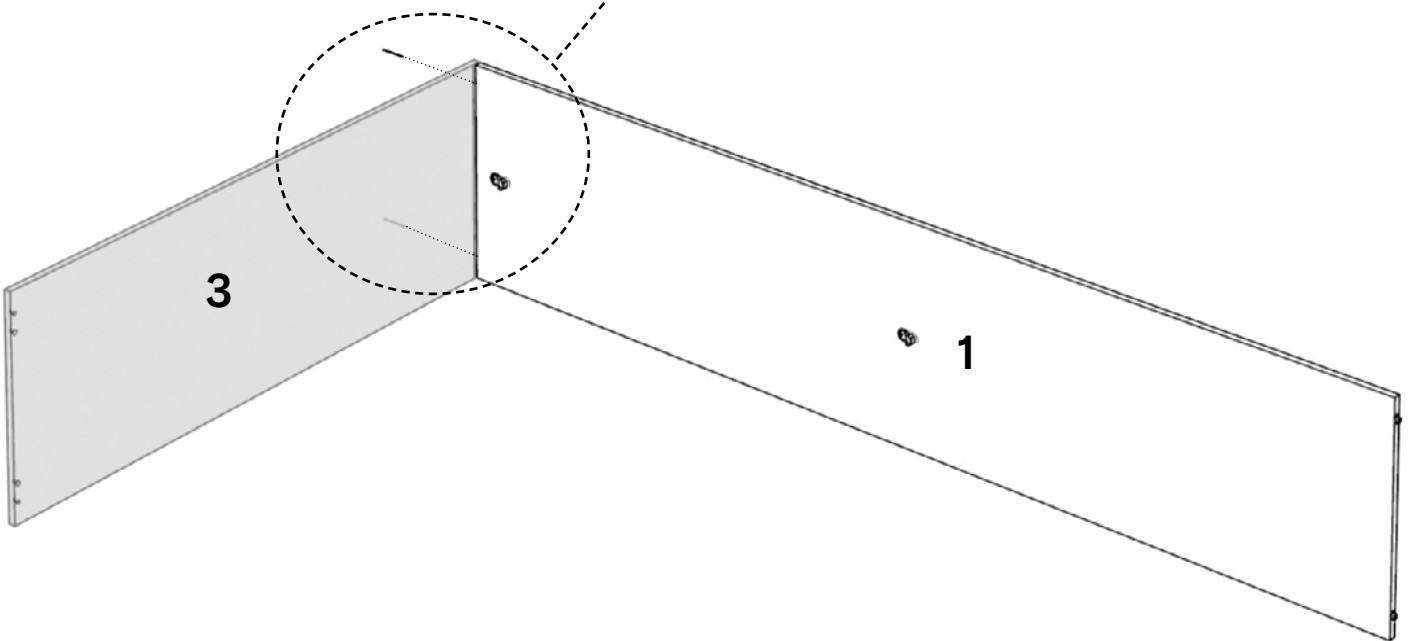
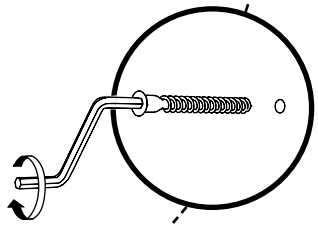
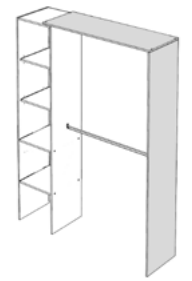

7

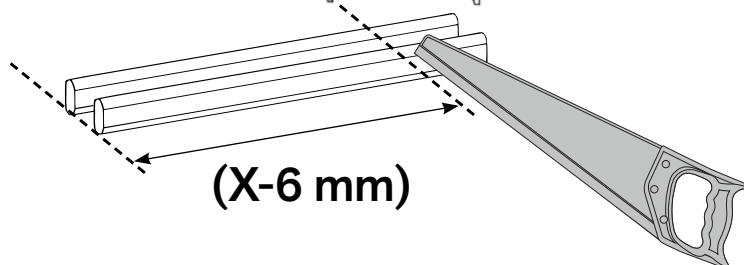
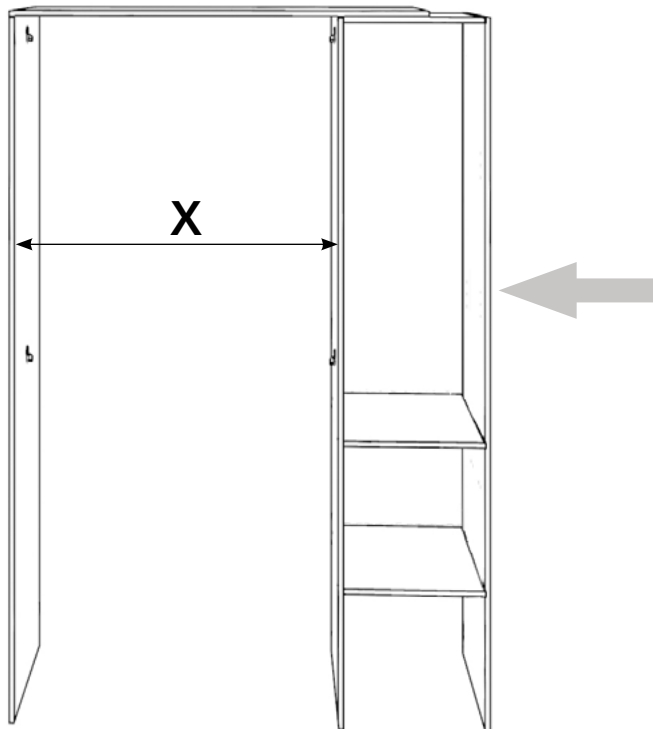
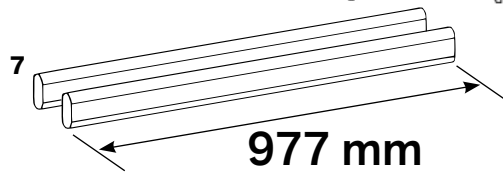
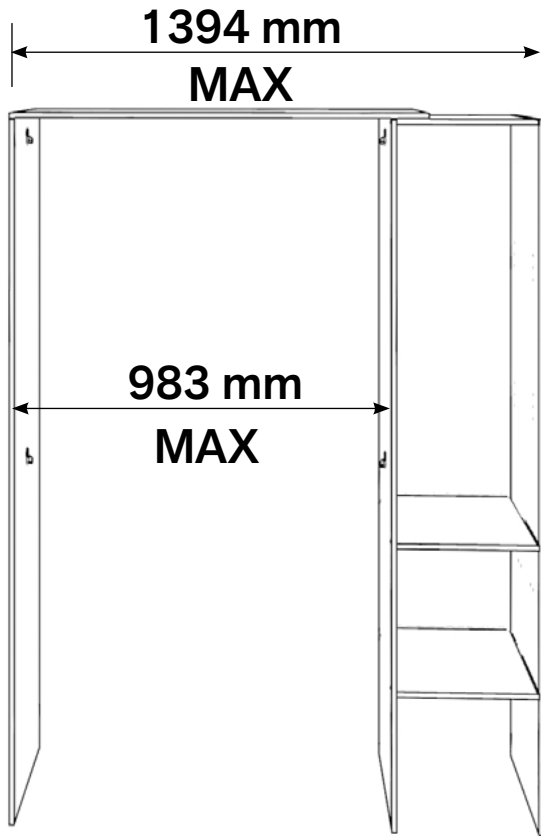

8

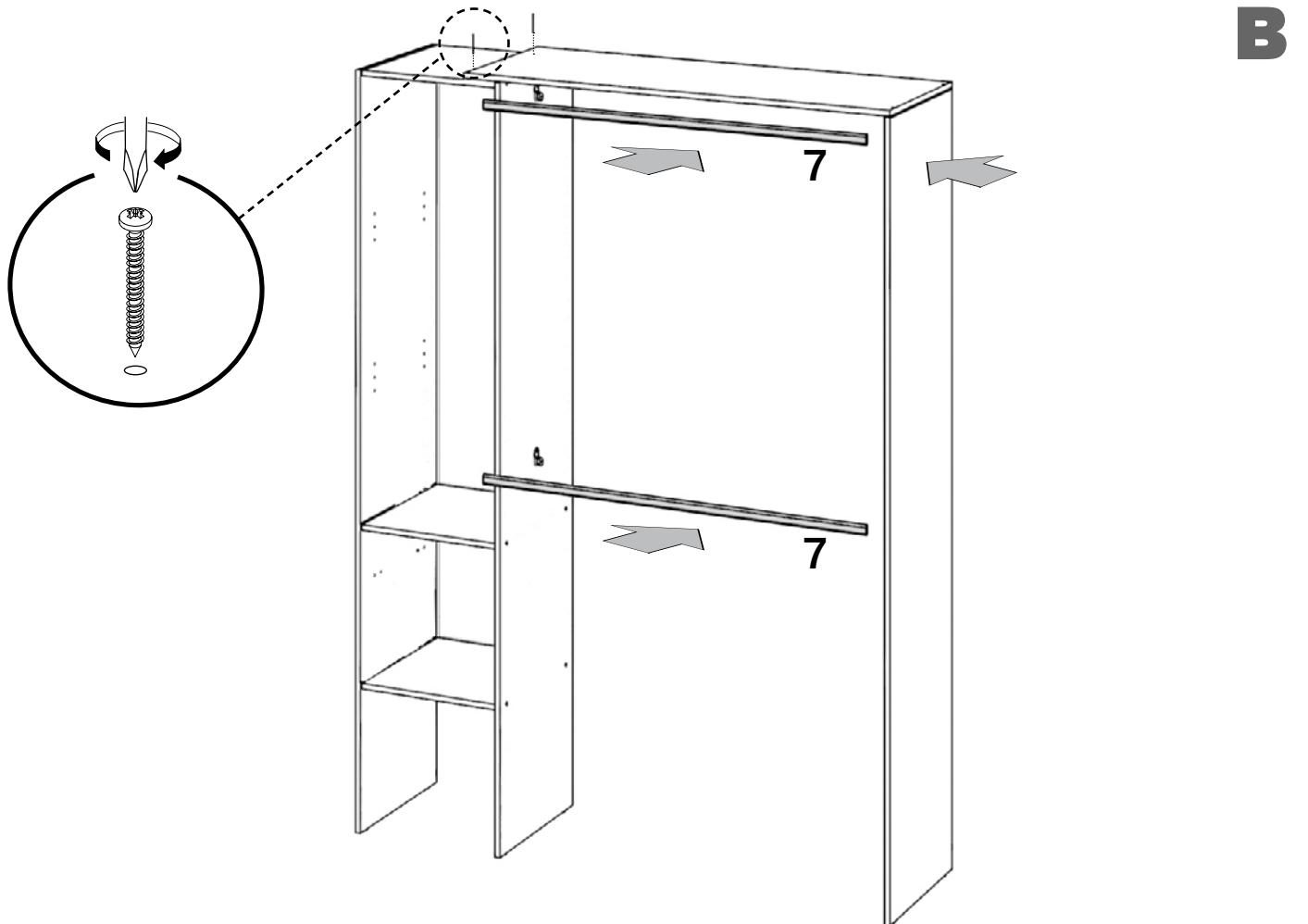
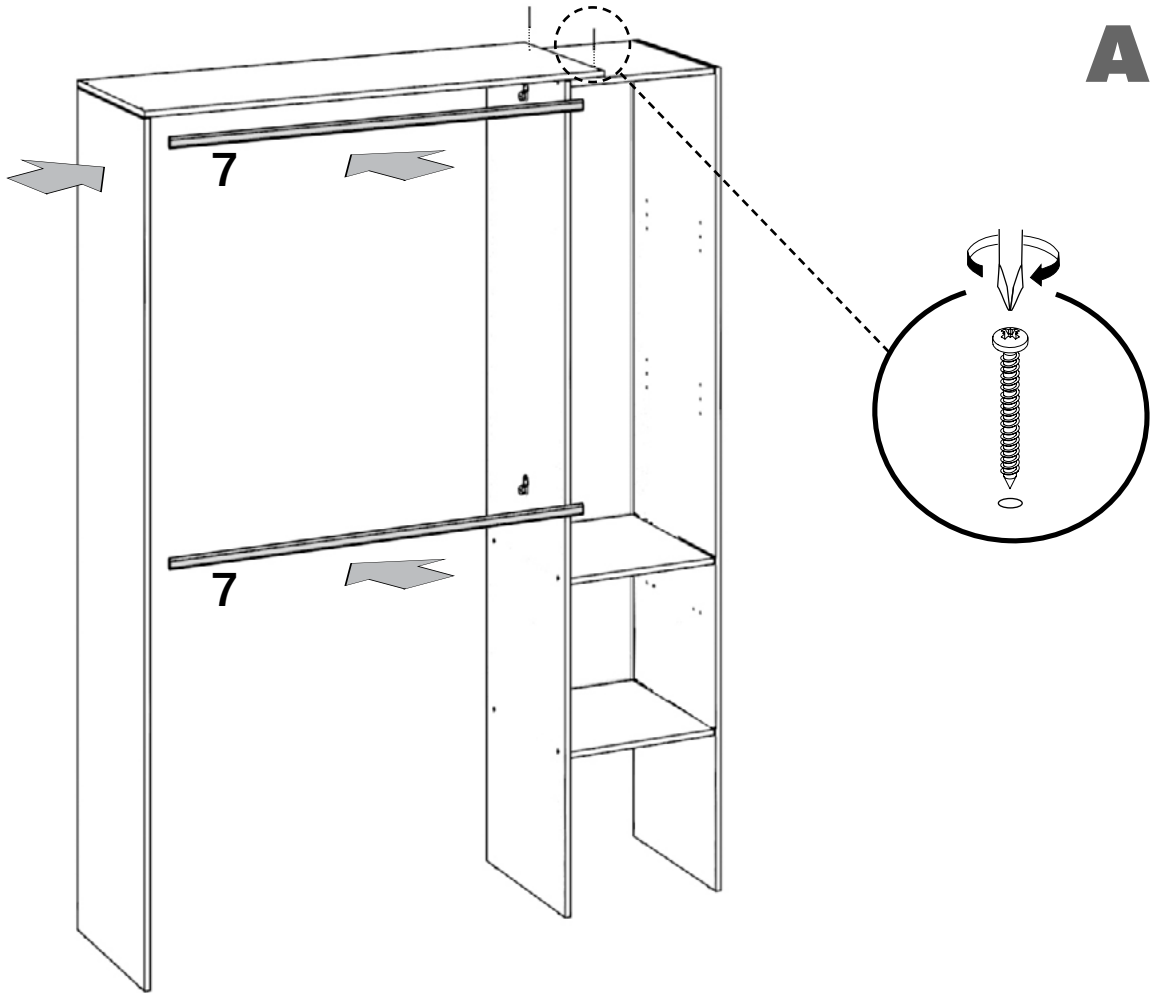
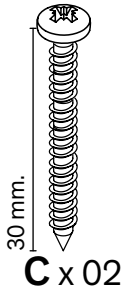

9

8 mm.

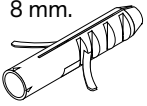

H x 02

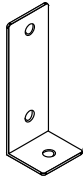

J x 02

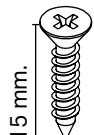

B x 02

45 mm.

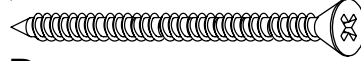

D x 02

A

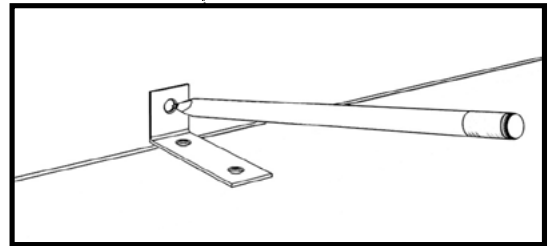
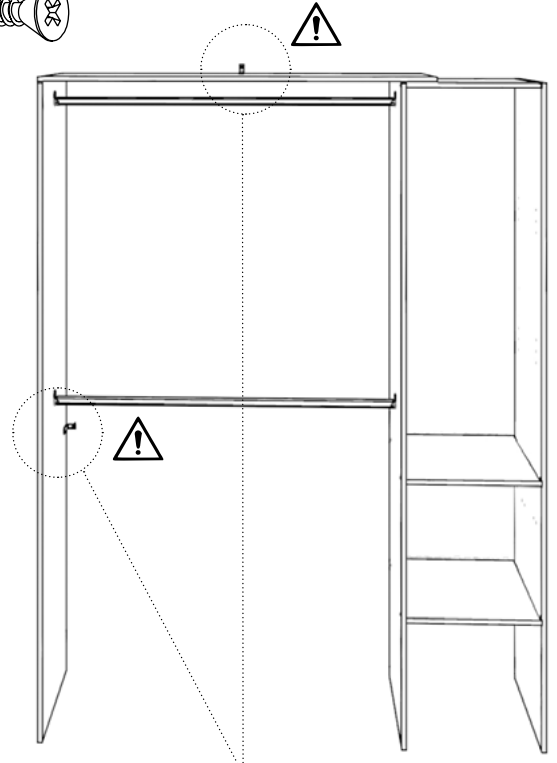
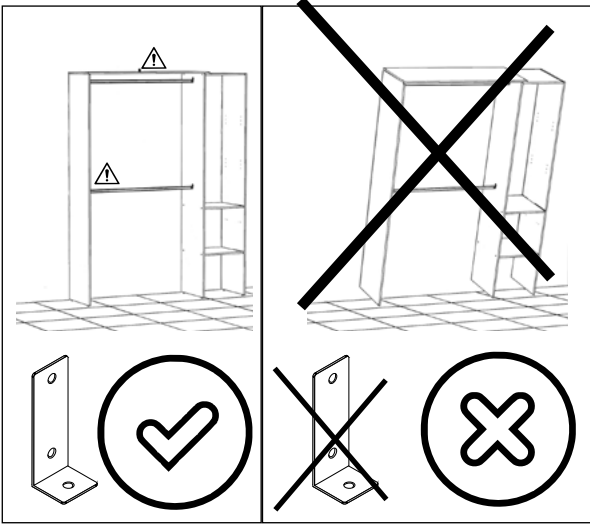

B

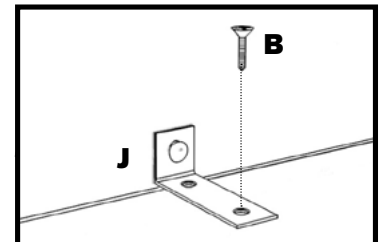
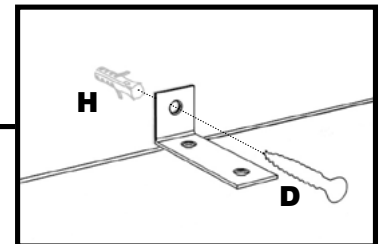
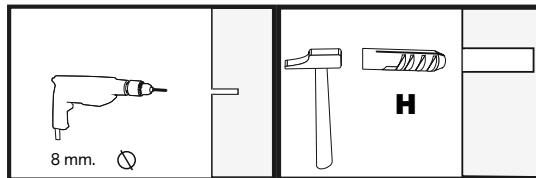
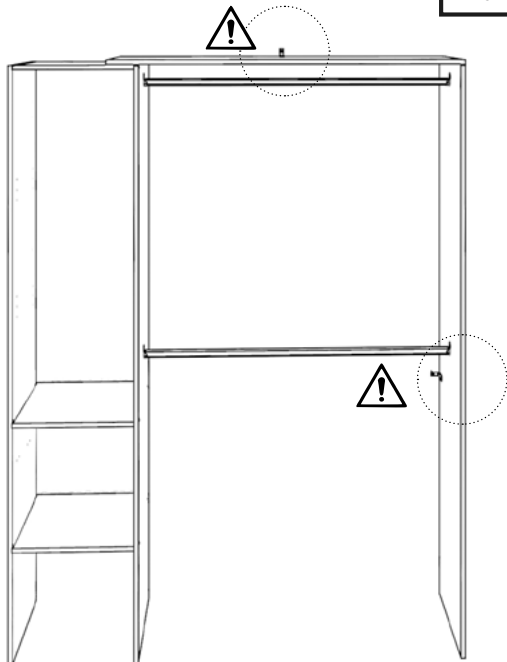

10

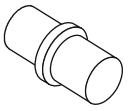

F x 08

A

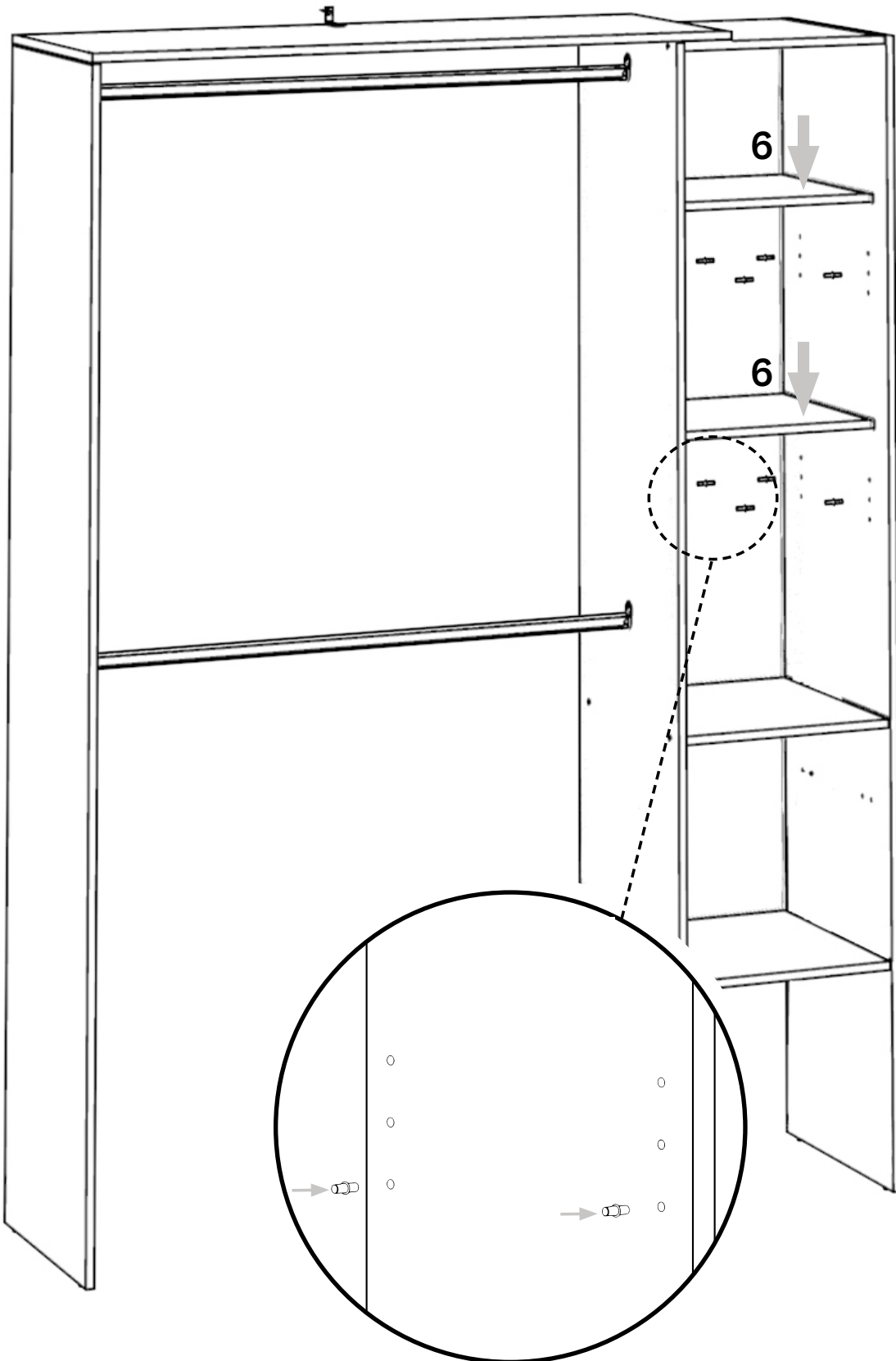

10

B

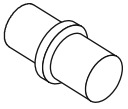

F x 08

