

A x 24 	B x 20 	C x 20 	D x 60 	E x 06 5 x 50 mm. 	F x 62 3.5 x 15 mm. 	G x 08 3.5 x 20 mm. 	I x 08 	J x 08 	
K x 06 	L x 04 	S x 01 Nº 3 	T x 01 Nº 4 	U x 08 15 mm. 	W x 02 				
H x 26 6.3 x 11 mm. 	M x 02 	N x 01 	N x 01 	O x 02 	P x 02 	Q x 02 	R x 02 		

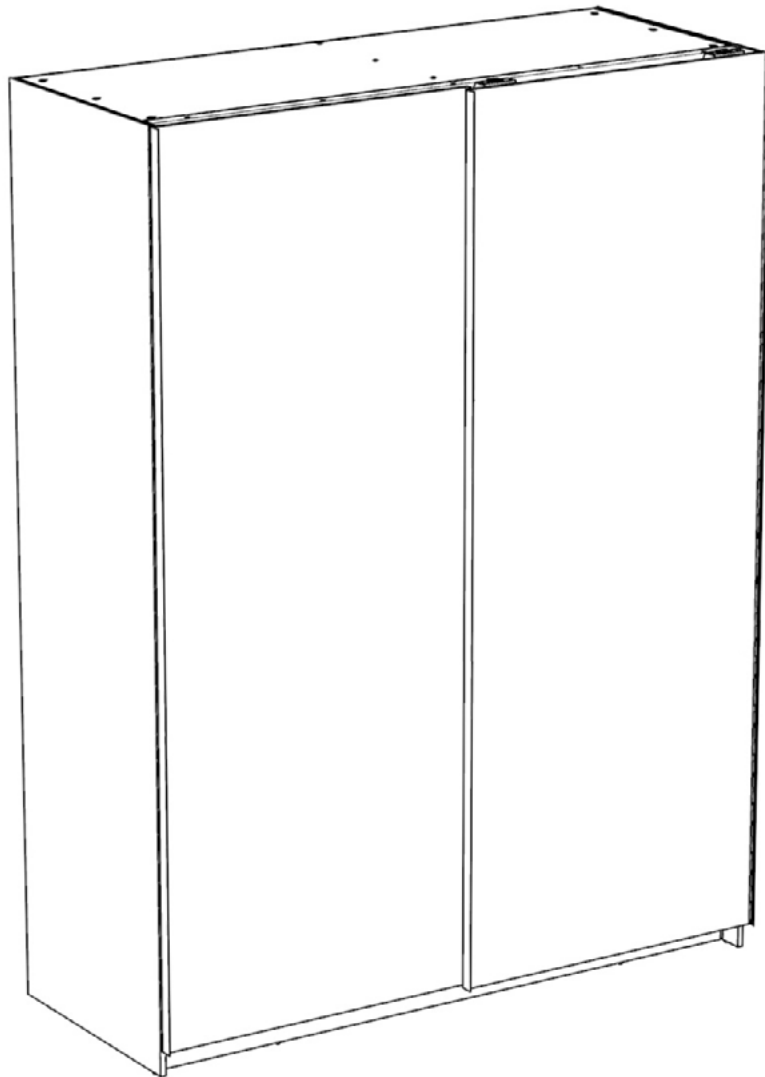

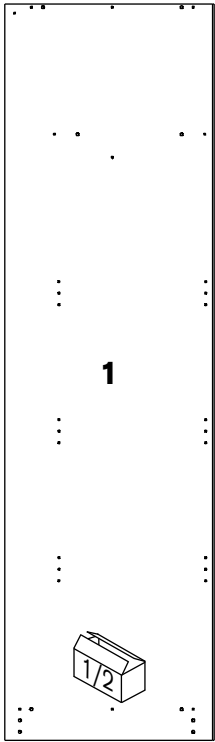

**1**

580 x 2040 mm.

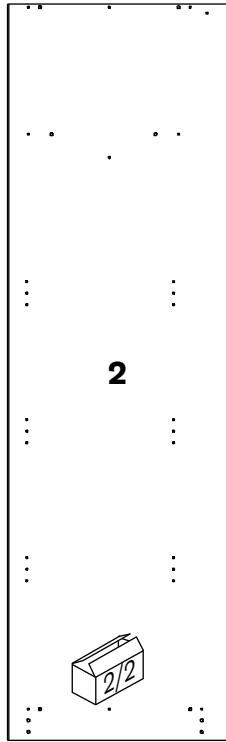

**2**

608 x 2040 mm.

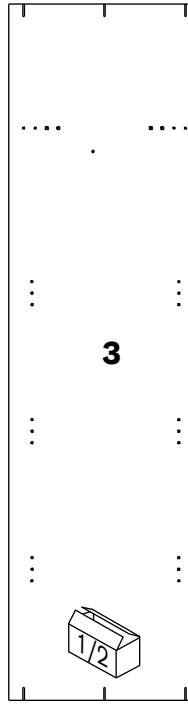

**3**

511 x 1929 mm.

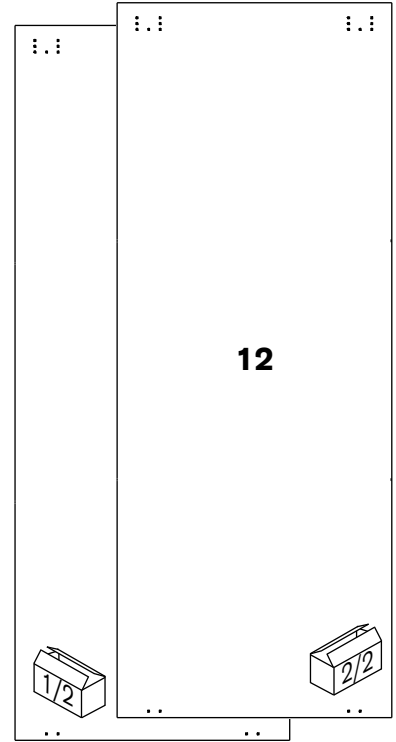

**12**

760 x 1980 mm.

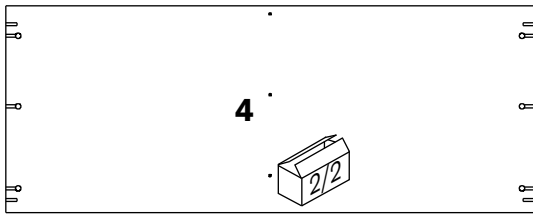

**4**

1464 x 572 mm.

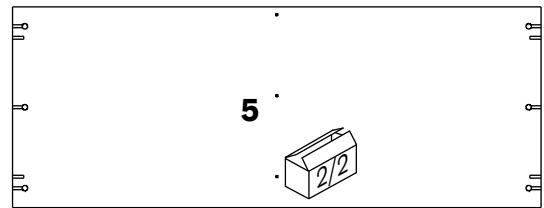

**5**

1464 x 556 mm.

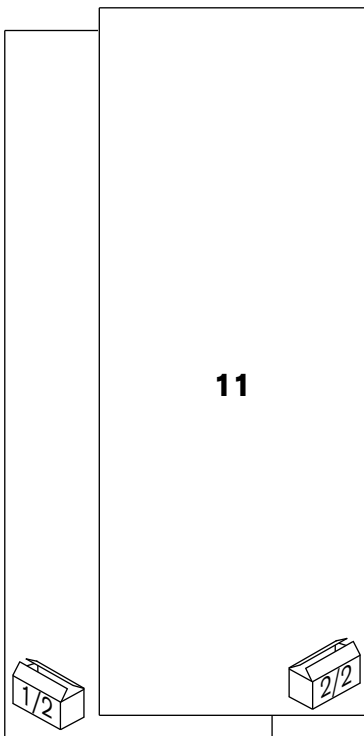

**11**

740 x 1960 mm.

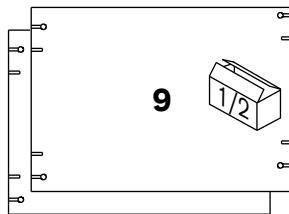

**9**

724 x 510 mm.

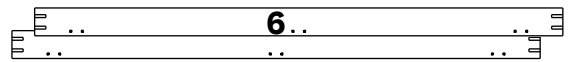

**6**

1464 x 78 mm.

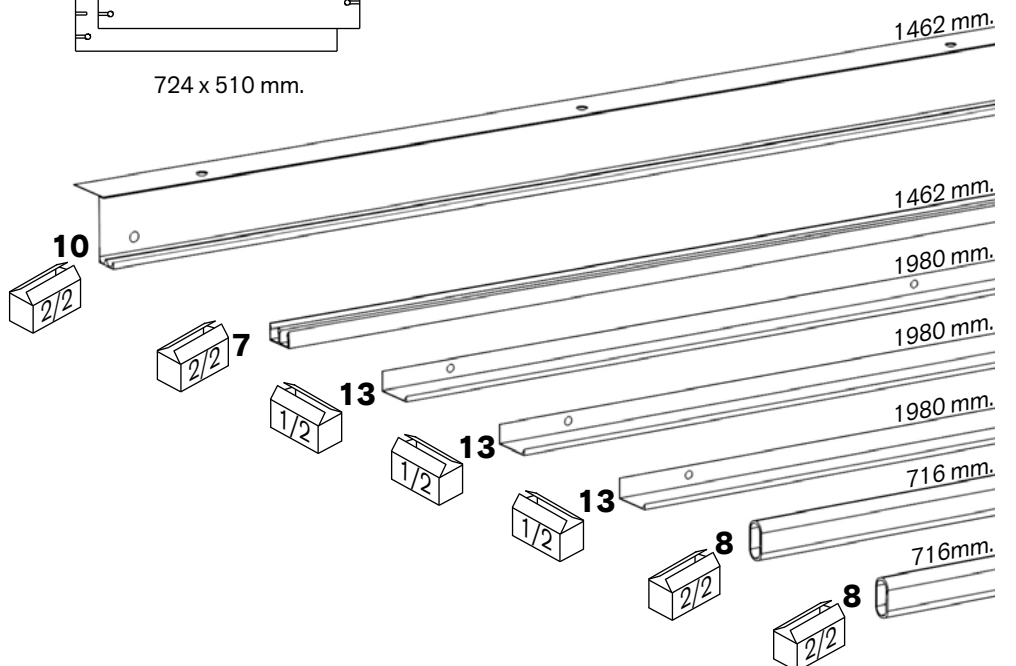

**10**

1462 mm.

**7**

1462 mm.

**13**

1980 mm.

**13**

1980 mm.

**13**

1980 mm.

**8**

716 mm.

**8**

716 mm.

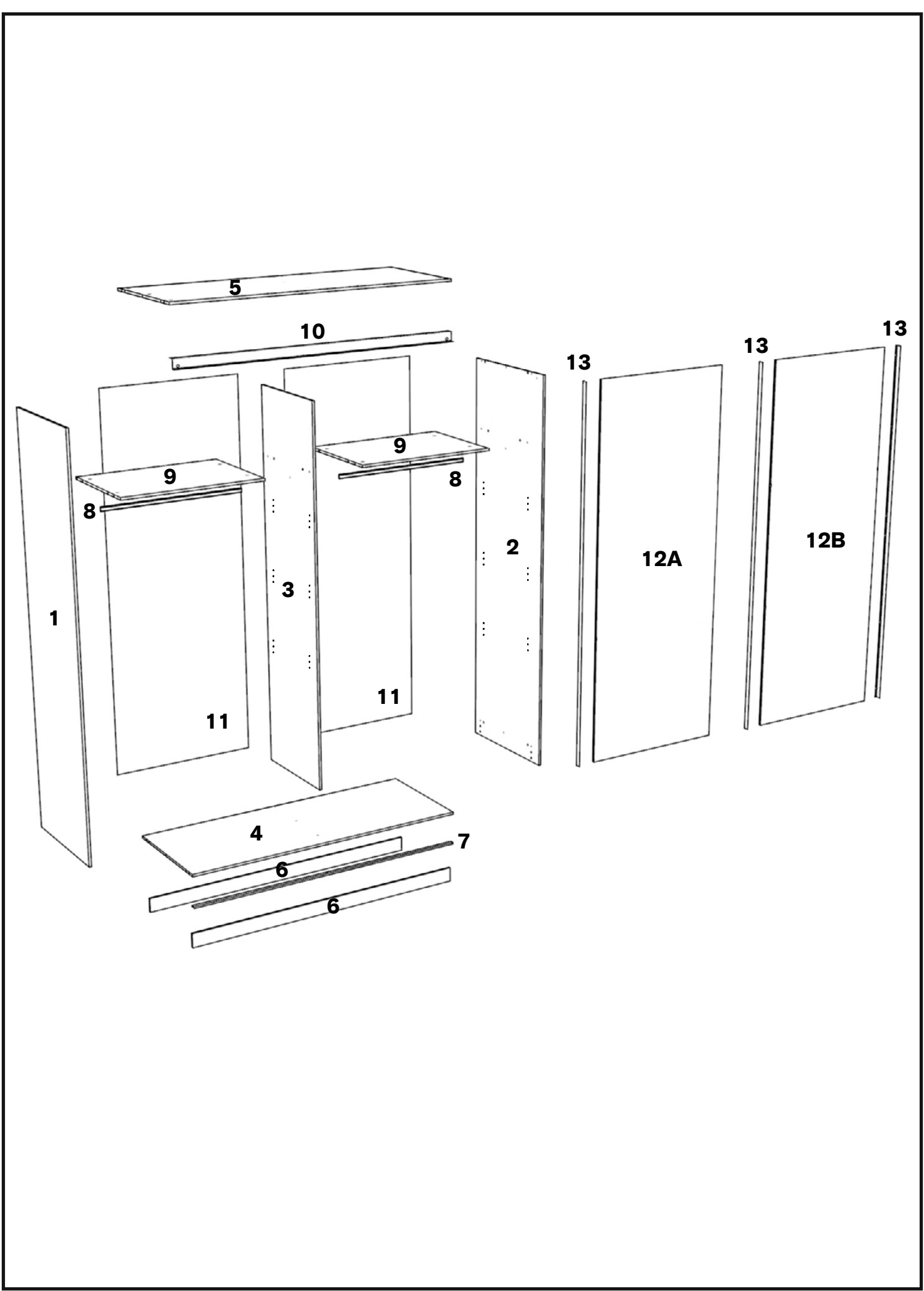

1

B x 08

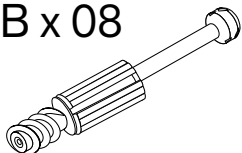

J x 02

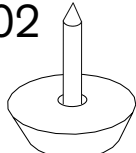

F x 02



3.5 x 15 mm.

G x 02

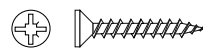

3.5 x 20 mm.

L x 01

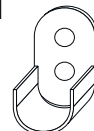

Q x 01

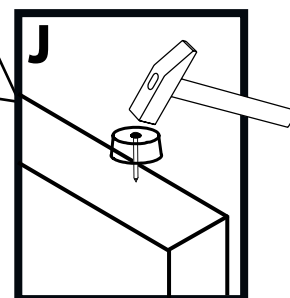
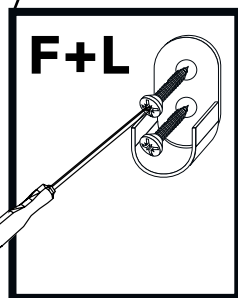
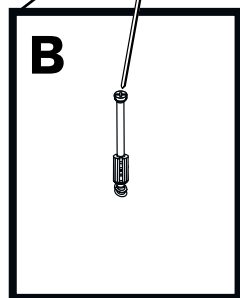
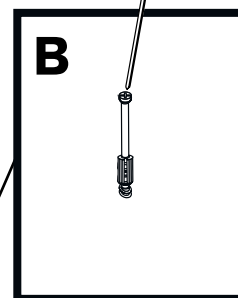
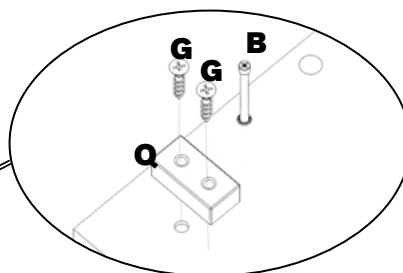
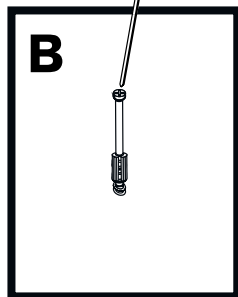
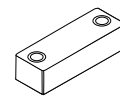

2

B x 08

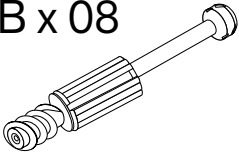

J x 02

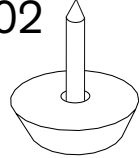

F x 02

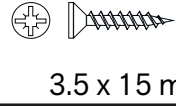

3.5 x 15 mm.

G x 02

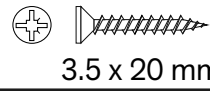

3.5 x 20 mm.

L x 01

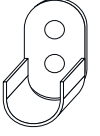

Q x 01

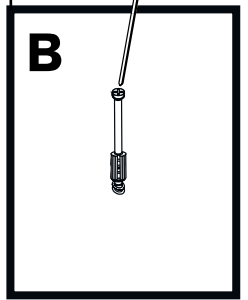
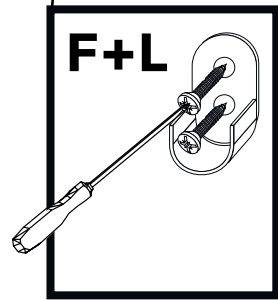
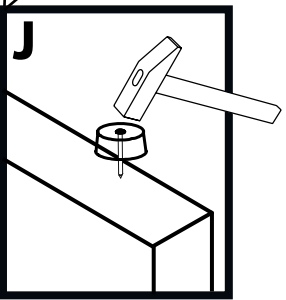
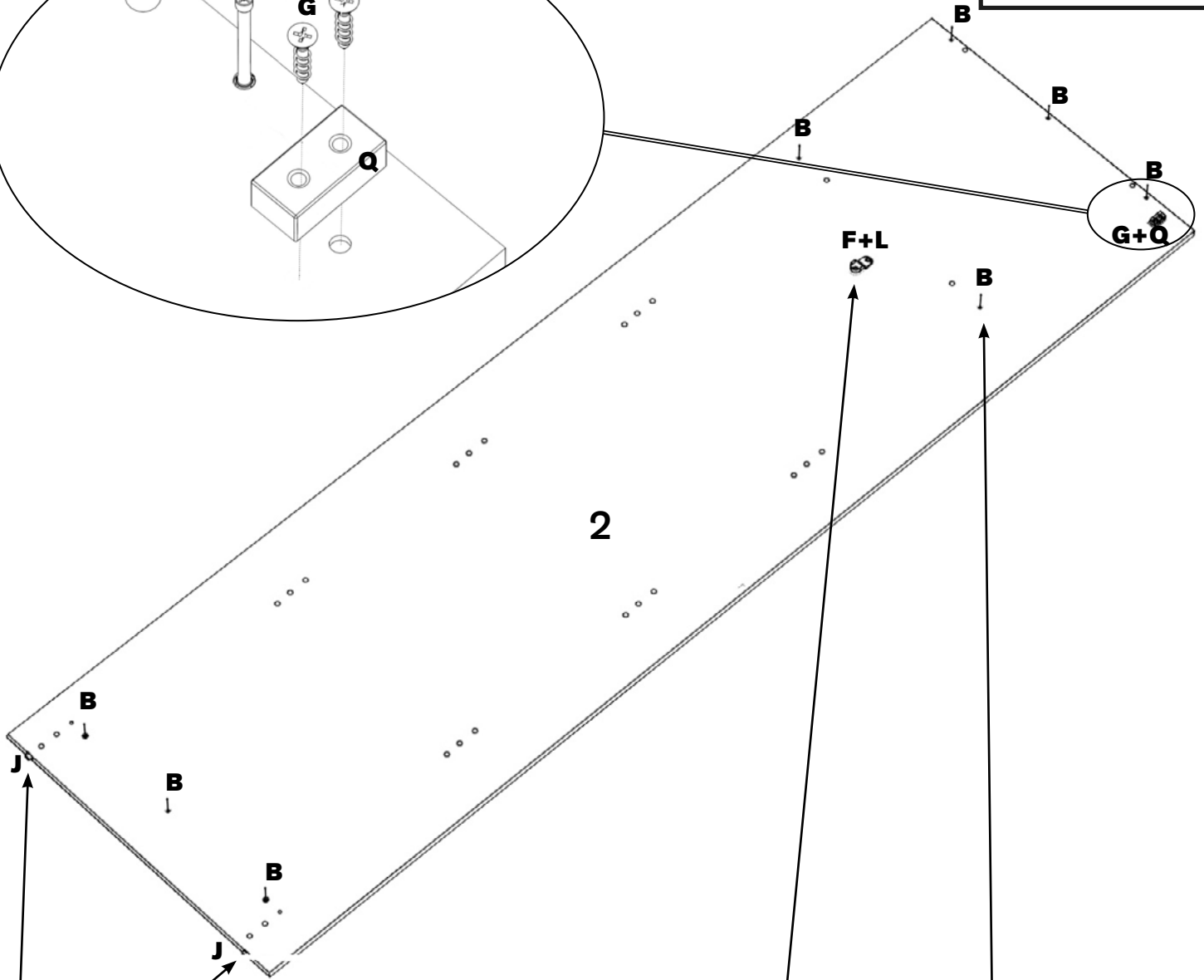
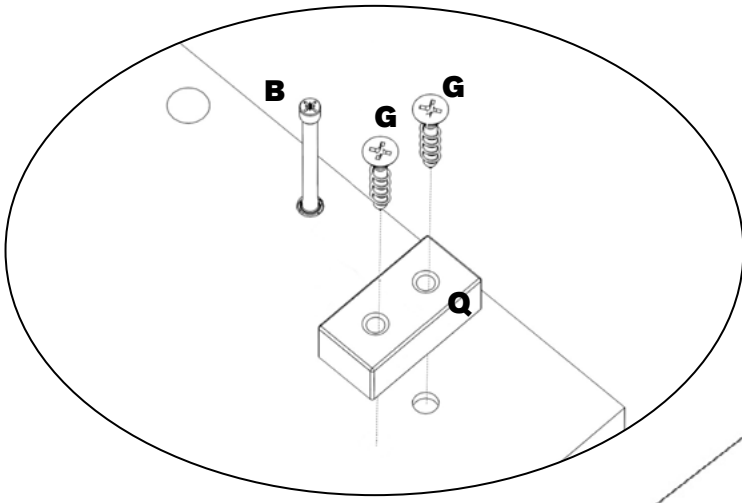
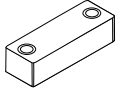

3

B x 04

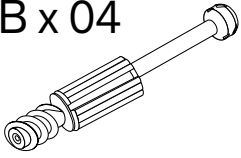

F x 04



3.5 x 15 mm.

L x 02

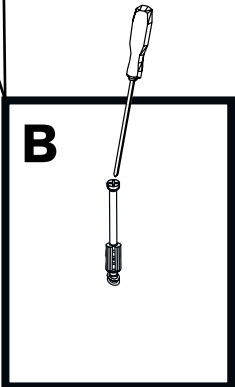
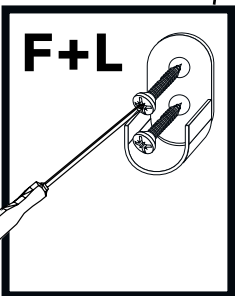
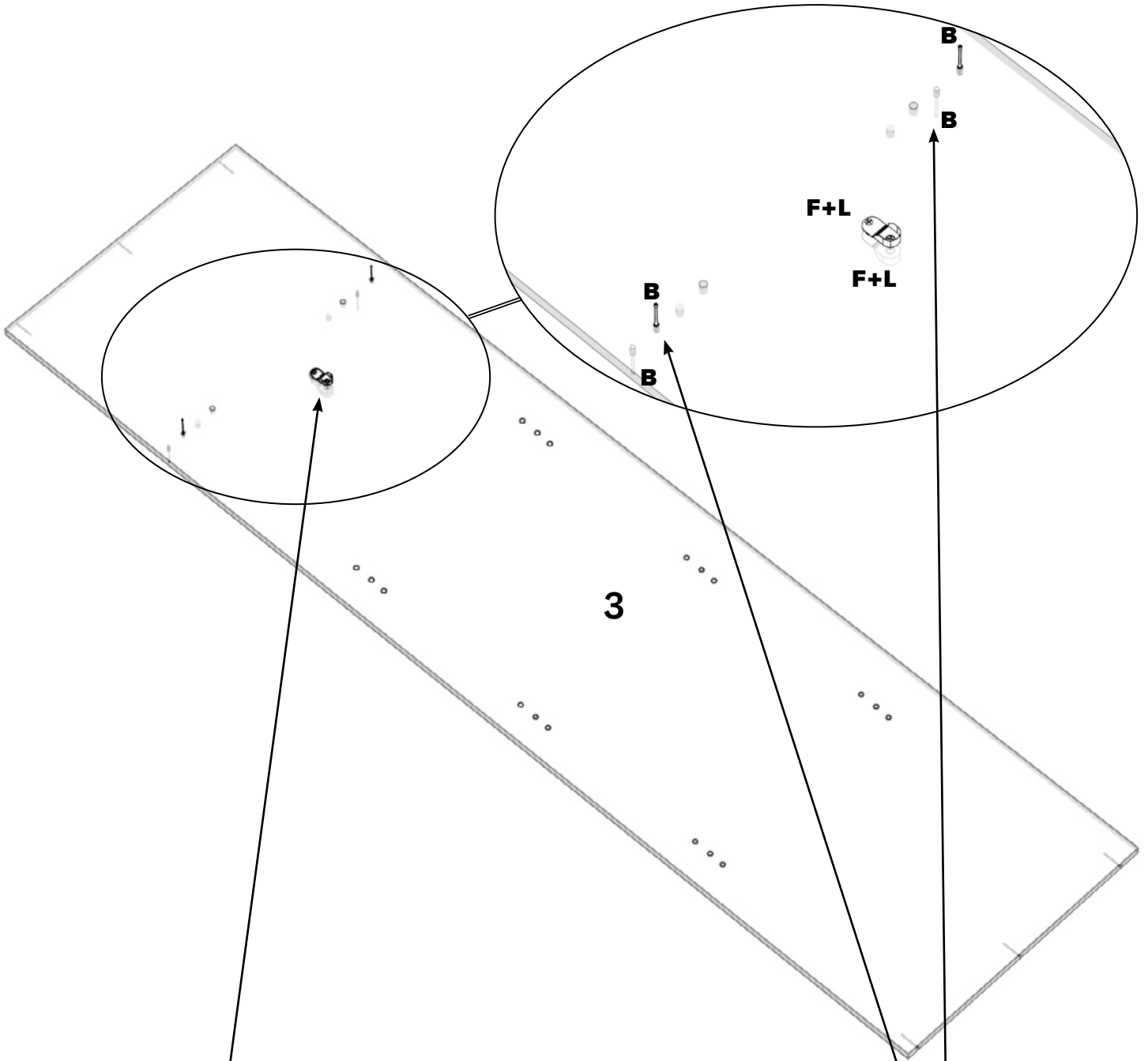
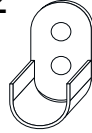

4 A x 04

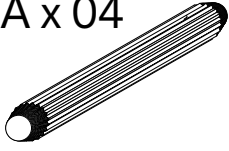

C x 06

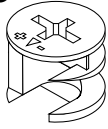

F x 05



3.5 x 15 mm.

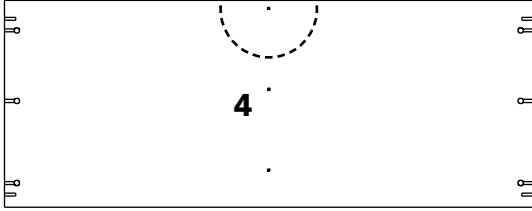

1464 x 572 mm.

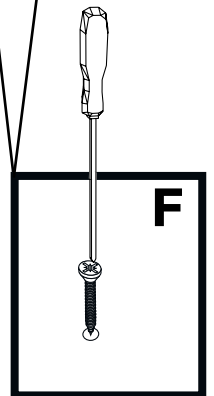
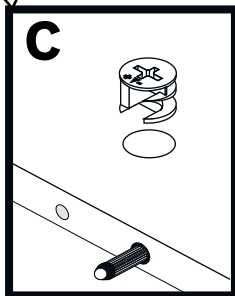
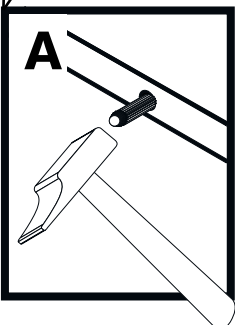
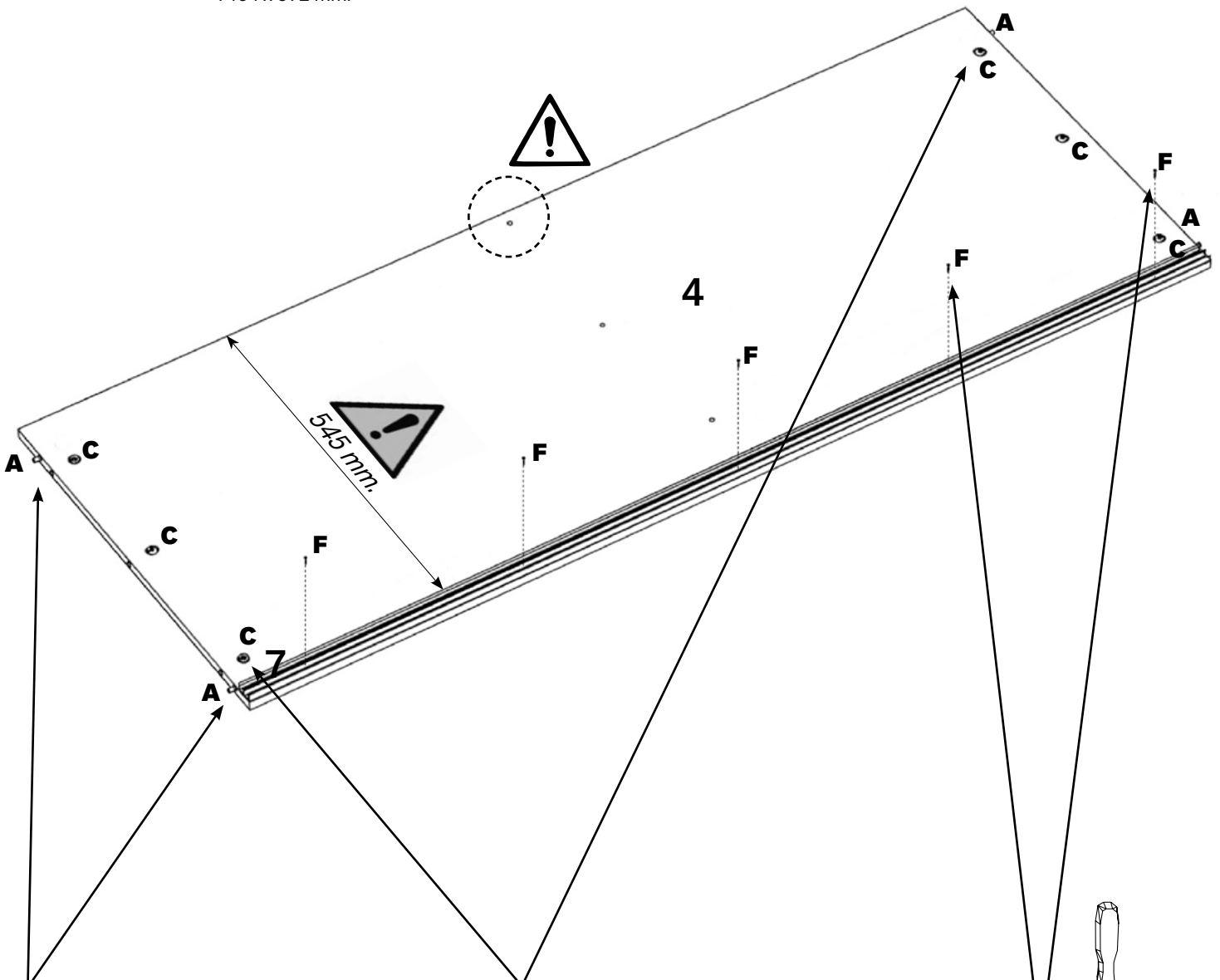

5

A x 04

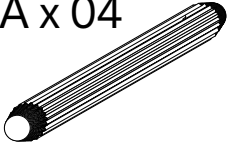

C x 06

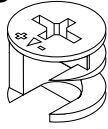

F x 05

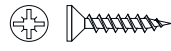

3.5 x 15 mm.

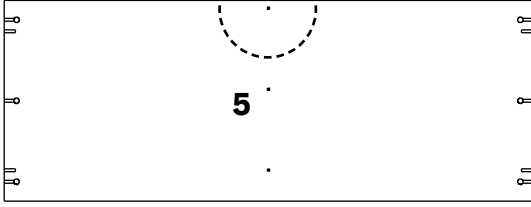

1464 x 556 mm.

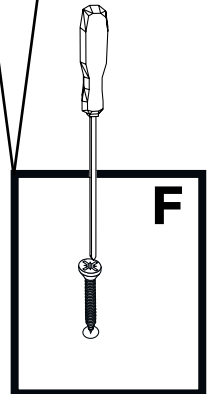
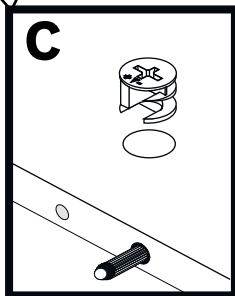
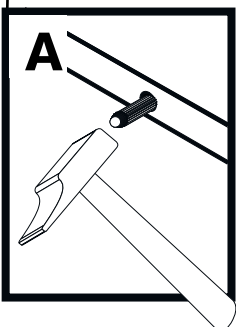
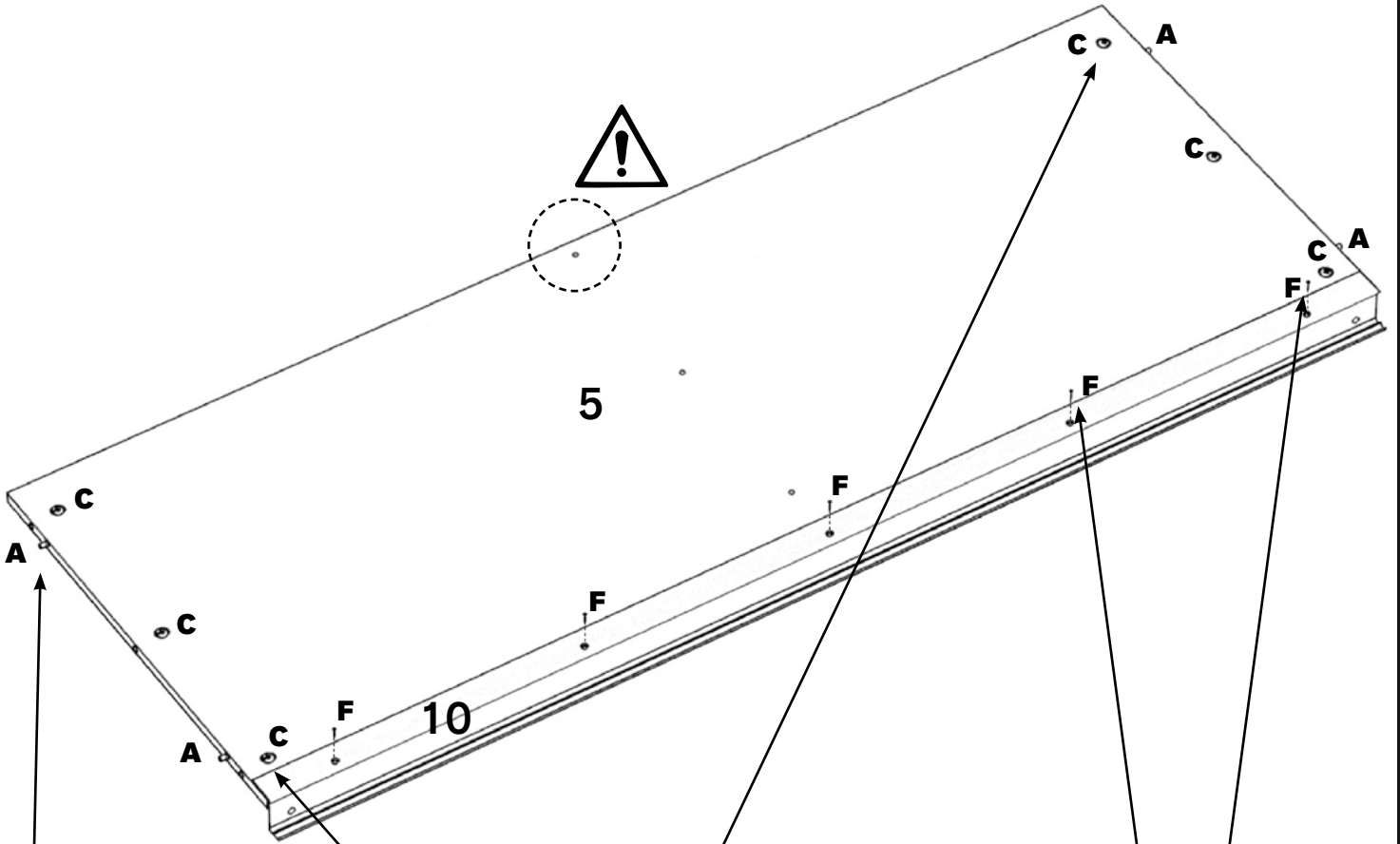



6

A x 08

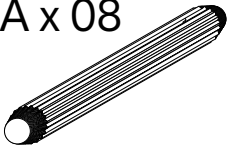

F x 12



3.5 x 15 mm.

J x 04

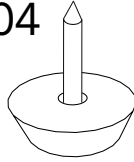

K x 06

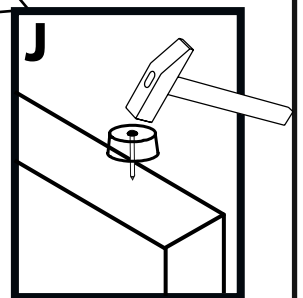
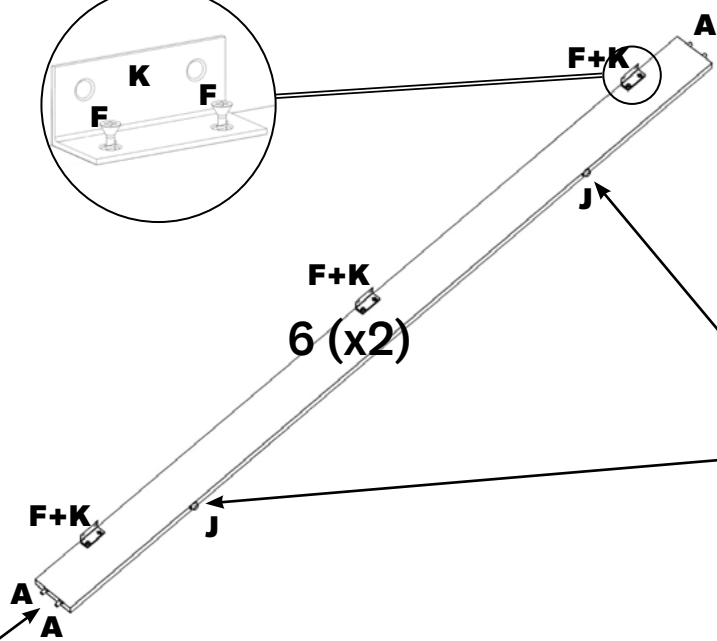
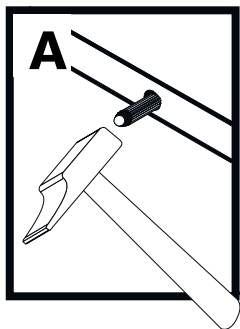
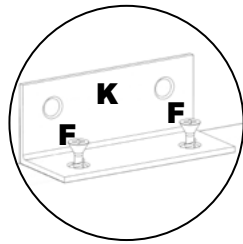
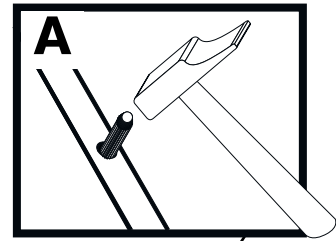
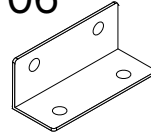

7

A x 08

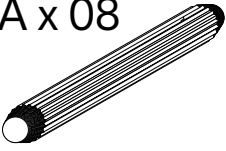

C x 08

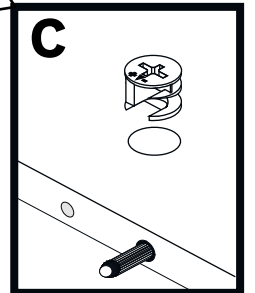
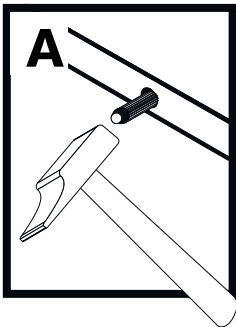
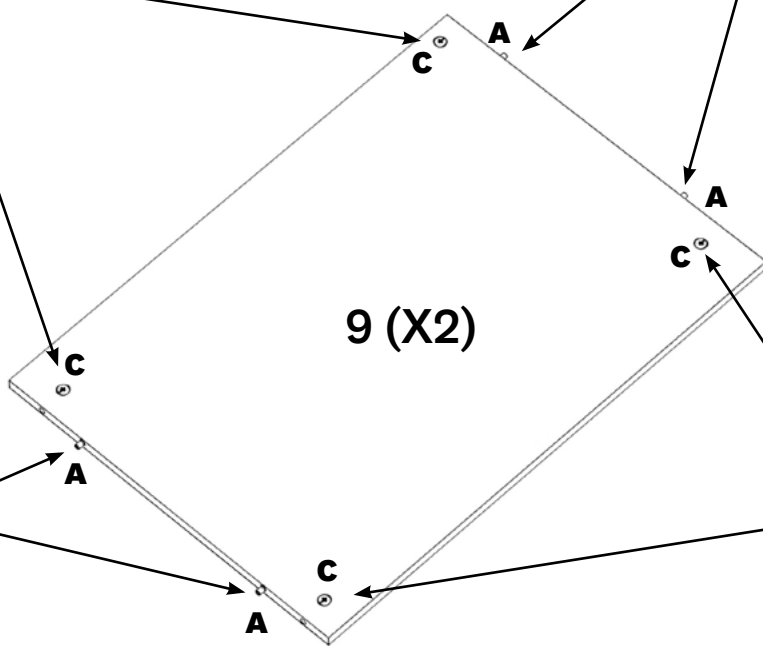
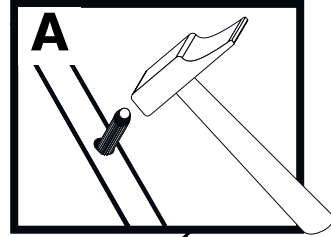
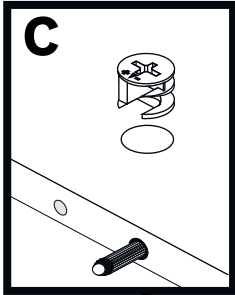
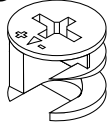

8

F x 06



3.5 x 15 mm.

H x 12



6,3 x 11 mm.

N x 01

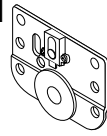

$\tilde{N}$  x 01

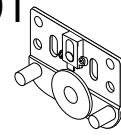

O x 02

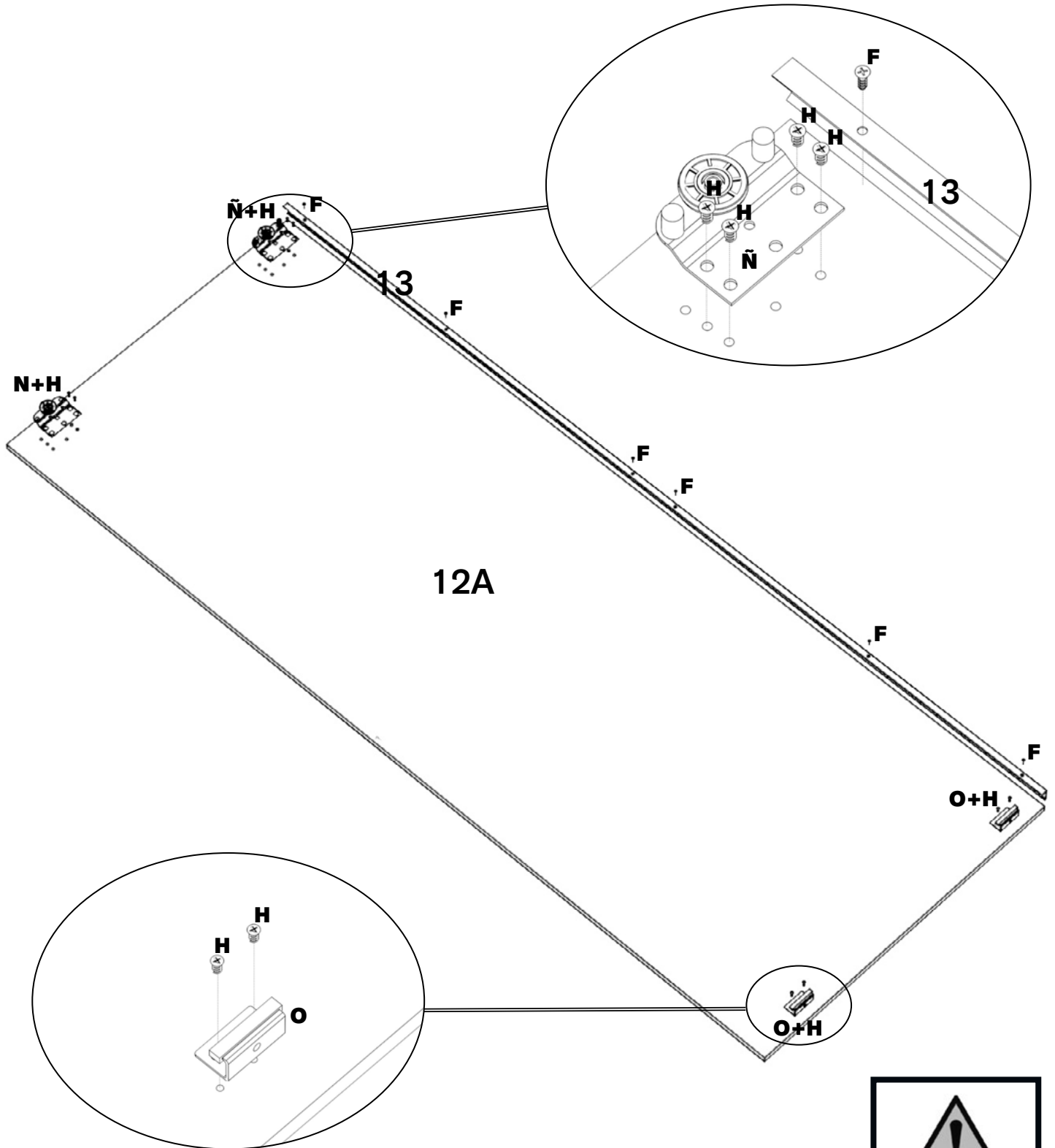

9

F x 12

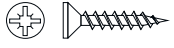

3.5 x 15 mm.

H x 14

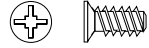

6,3 x 11 mm.

M x 02

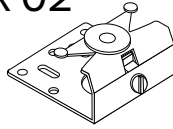

P x 02

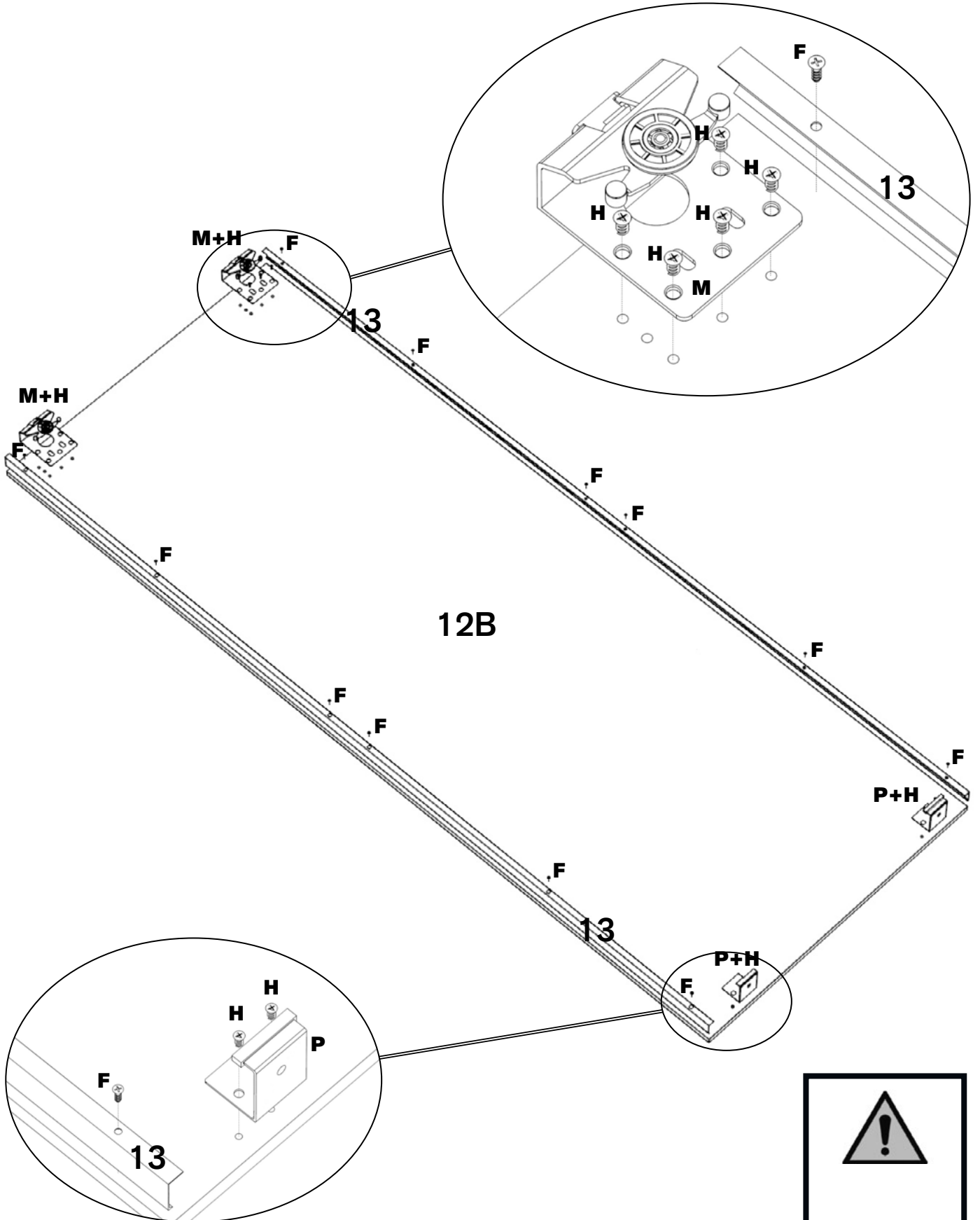
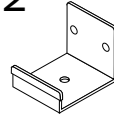

10

E x 06



5 x 50 mm.

S x 01

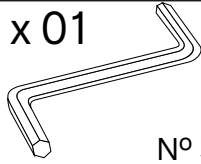

N° 3

T x 01

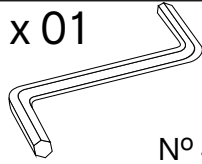

N° 4

U x 04

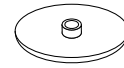

15 mm.

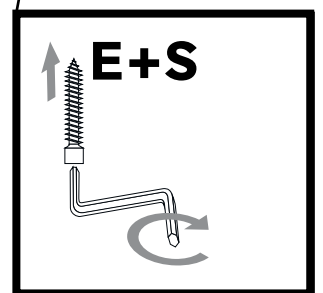
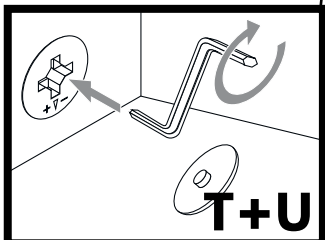
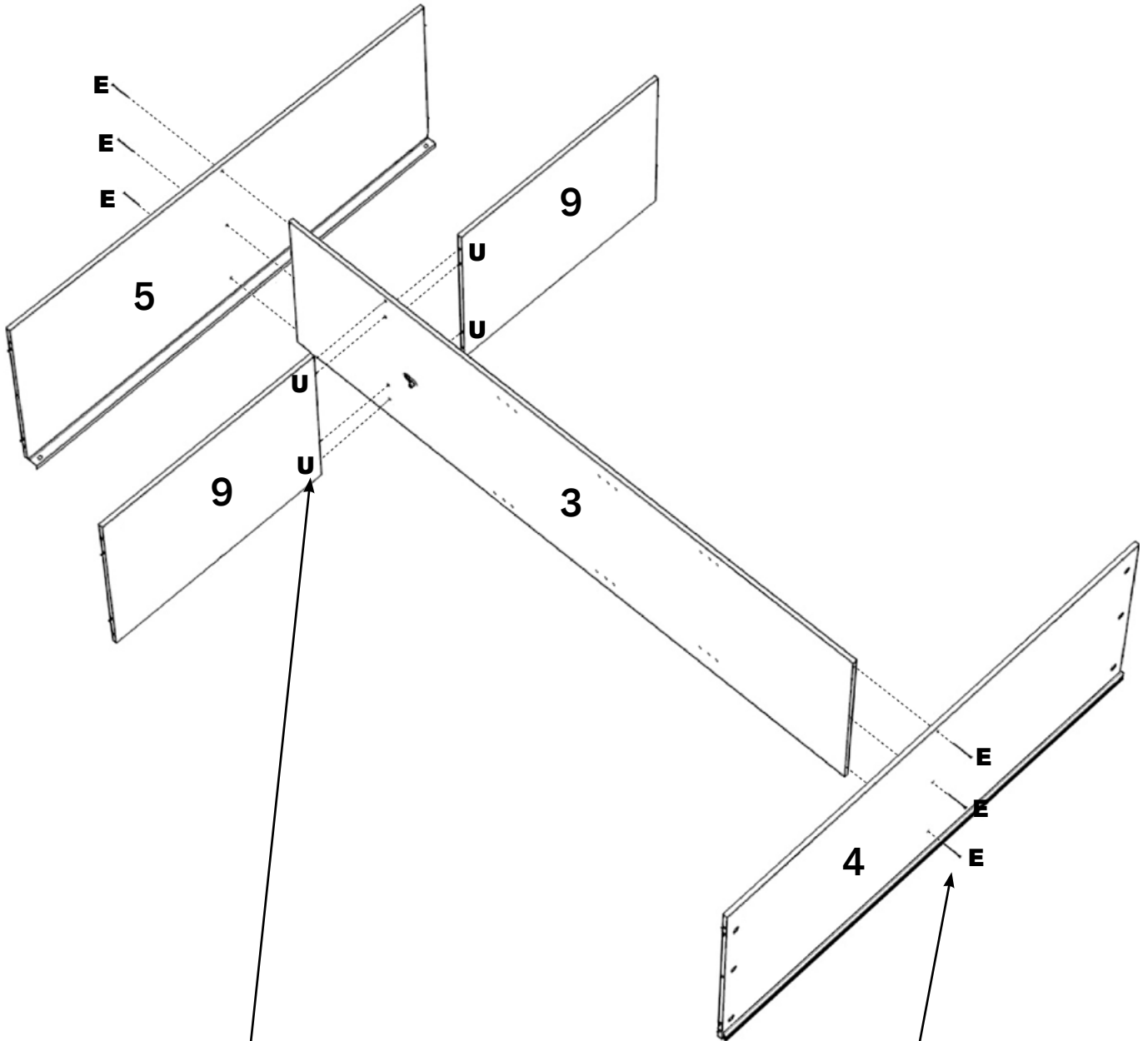

11

T x 01

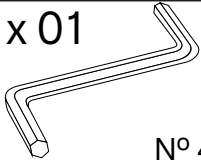

N° 4

U x 04

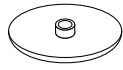

15 mm.

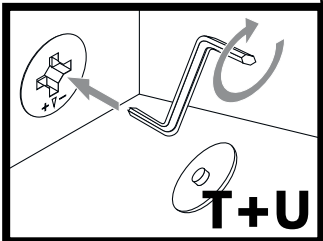
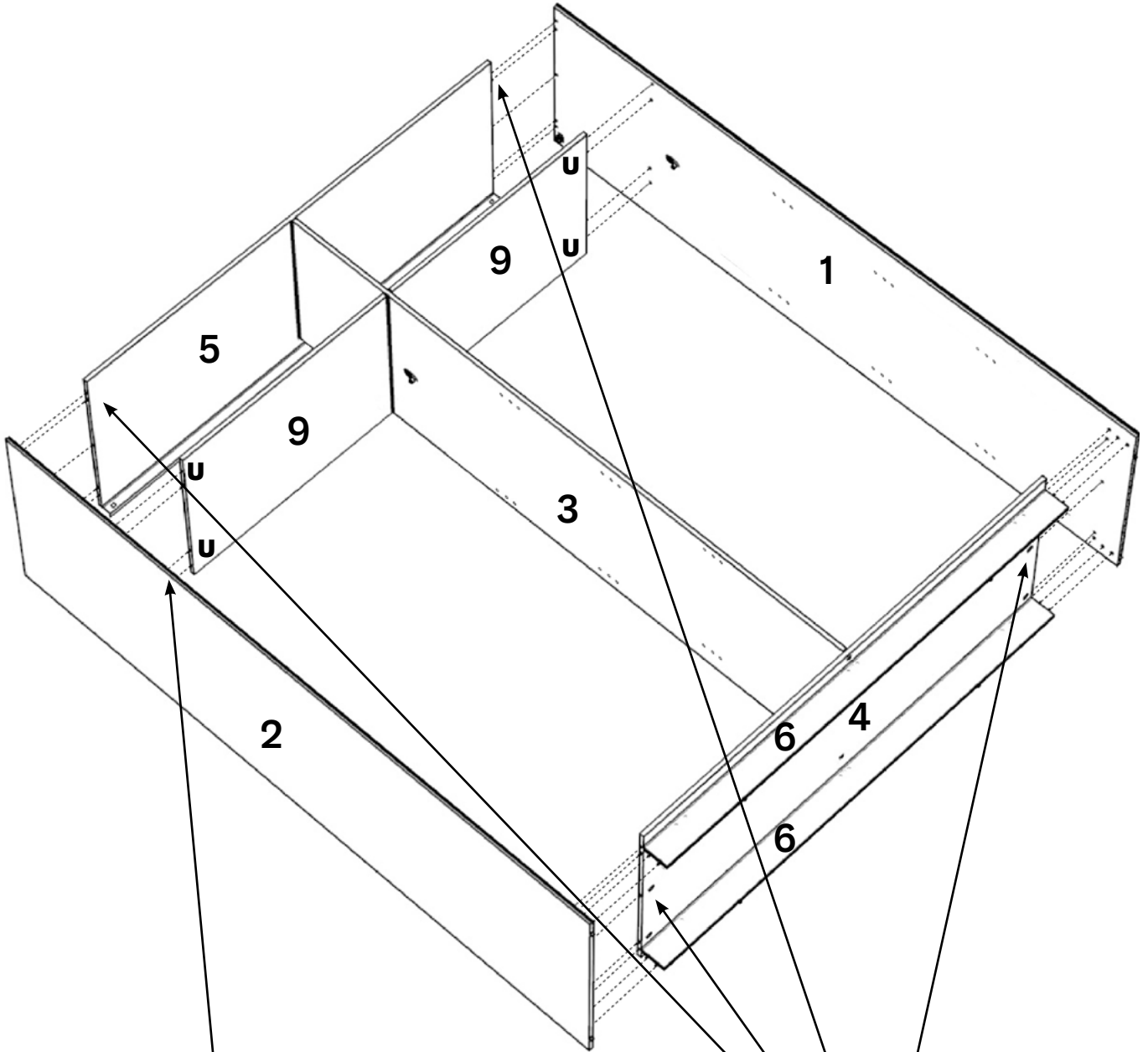

T+U

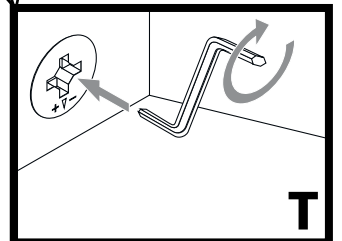

T

12

D x 60

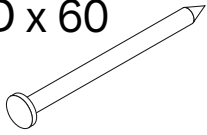

F x 12



3.5 x 15 mm.

G x 08

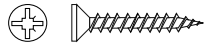

3.5 x 20 mm.

I x 08

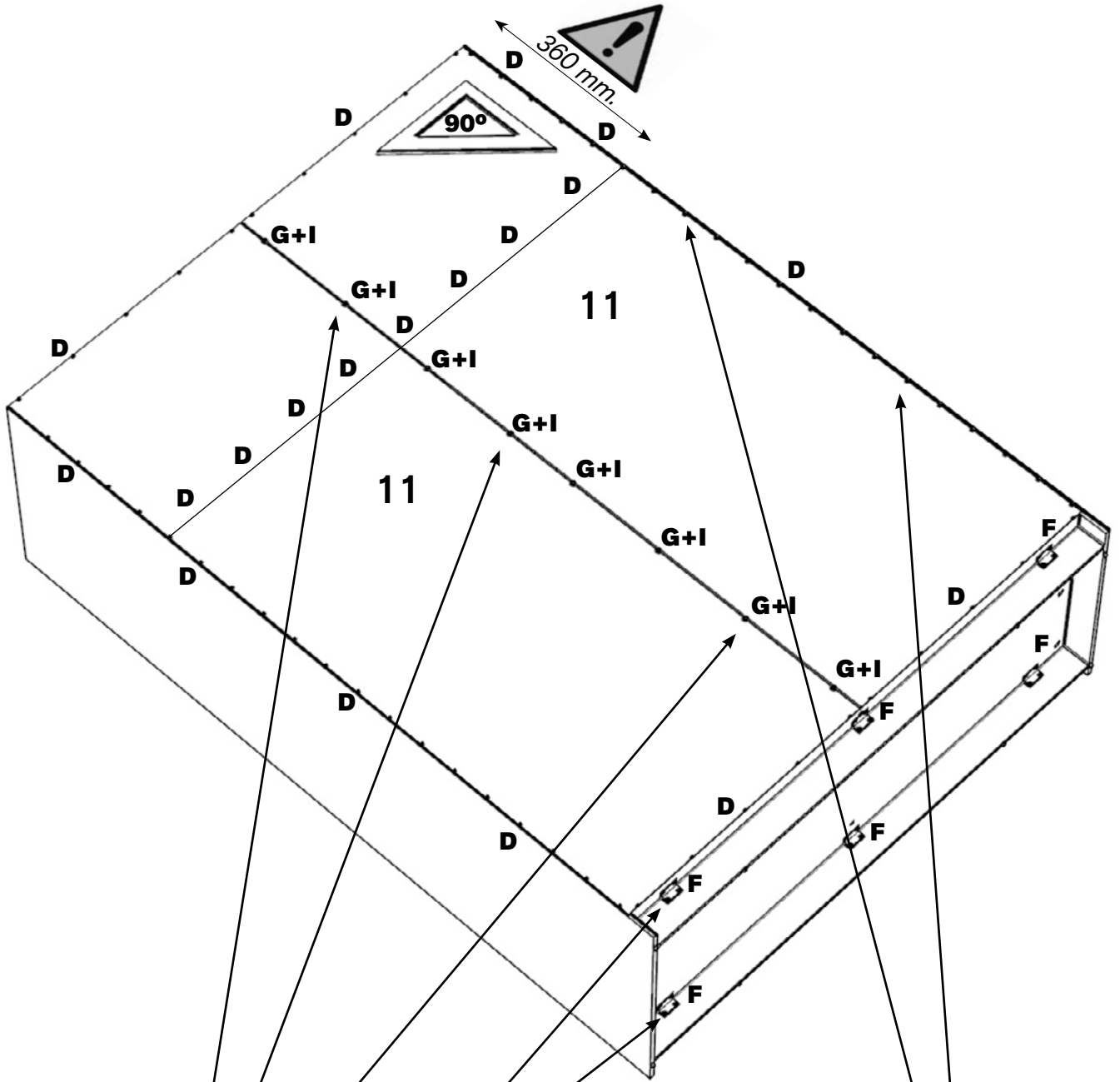
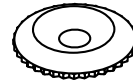

G+I

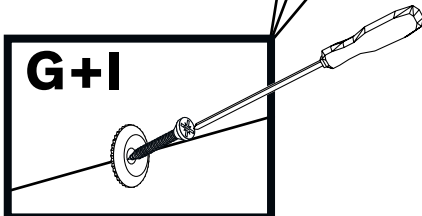

F

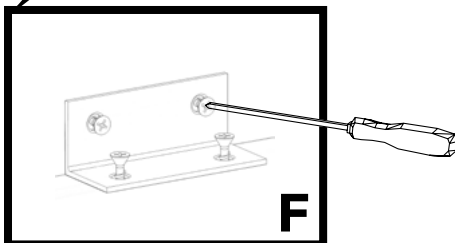

D

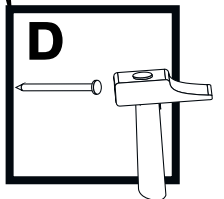

**13** R x 02

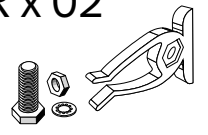
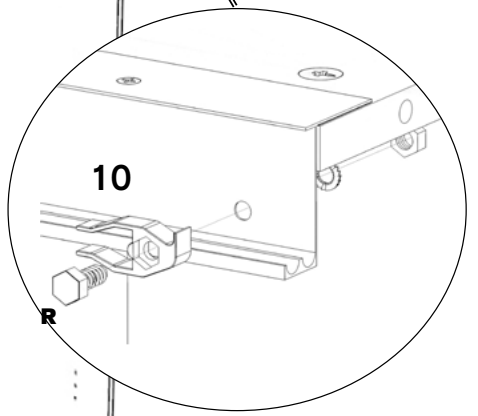
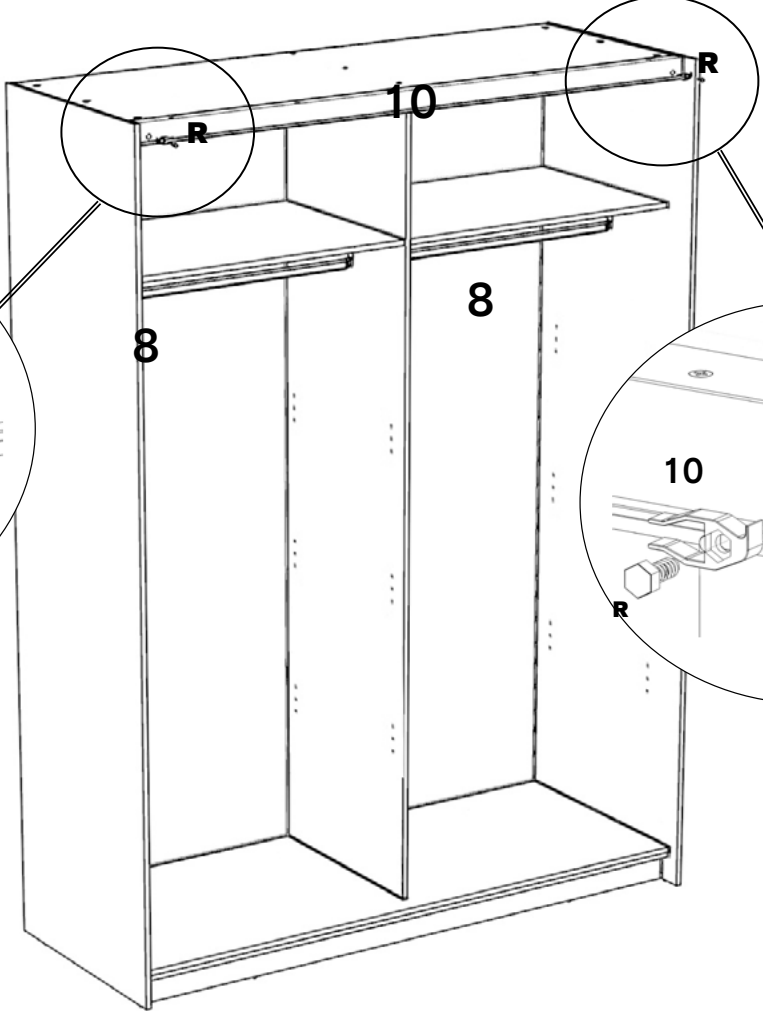
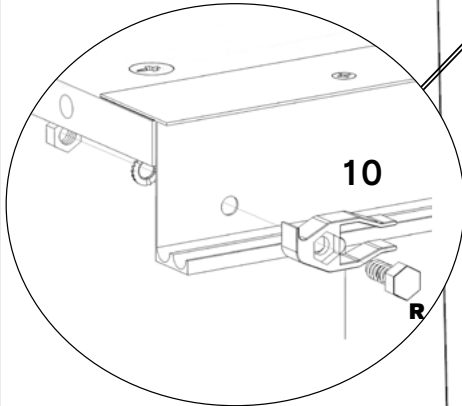

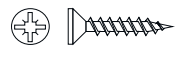

**14** F x 02

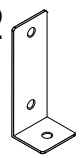
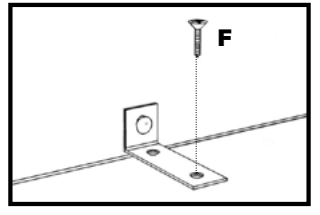
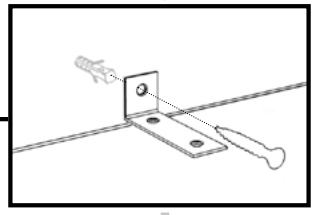
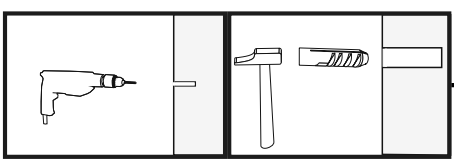
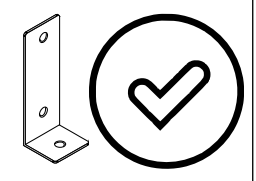
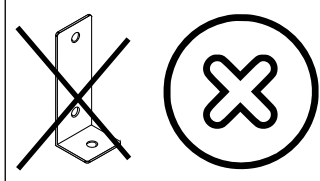
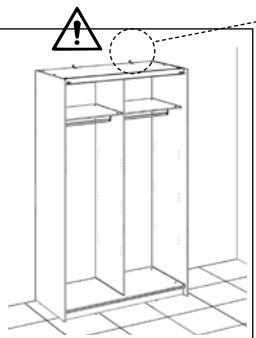
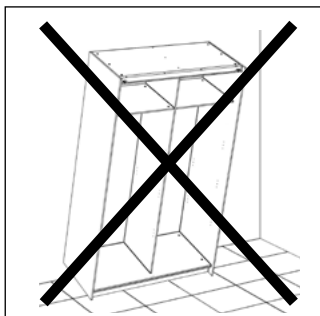
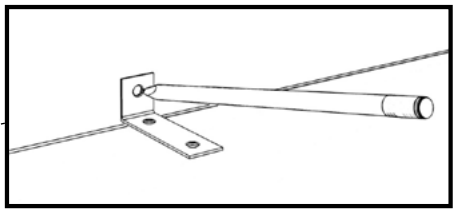

3.5 x 15 mm.

W x 02



15

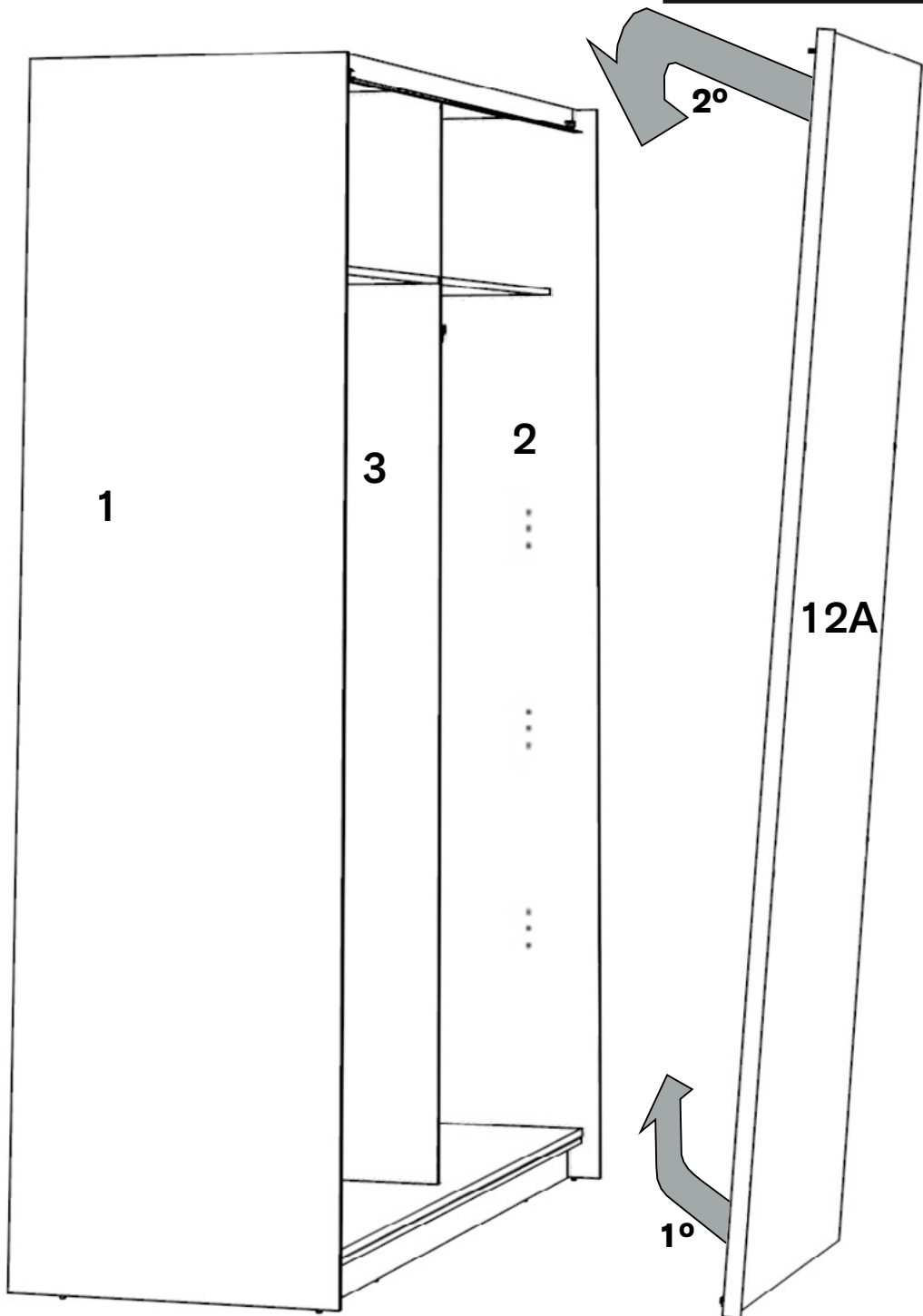
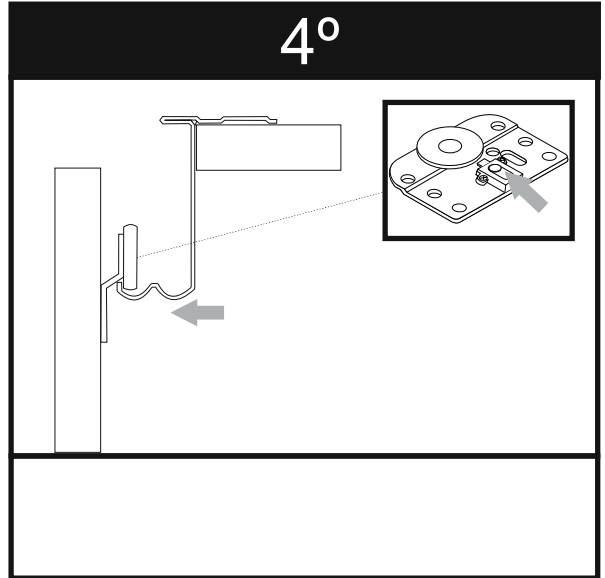
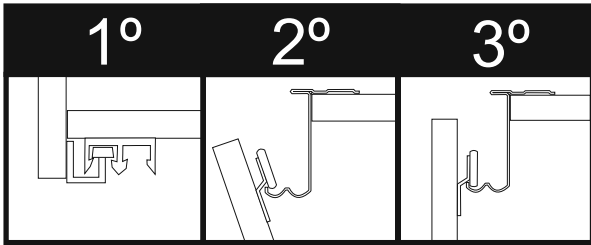

16

