

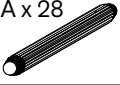

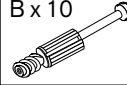

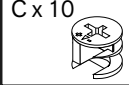

A x 28 	B x 10 	C x 10 	D x 04 	E x 16  3,5 x 15 mm.	F x 04  M6 x 60 mm.	G x 03  5 x 60 mm.	H x 04  13 mm.	I x 06 
J x 01  N° 3	K x 01  N° 4		M x 05 	N x 10  M4 x 15 mm.	O x 10  M4 x 10 mm.	P x 10  4 x 20 mm.		

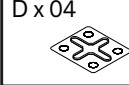
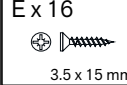
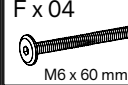
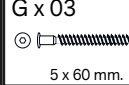
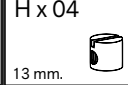

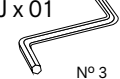
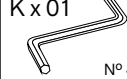

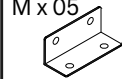
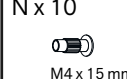
786 X 332 mm.

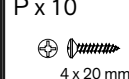
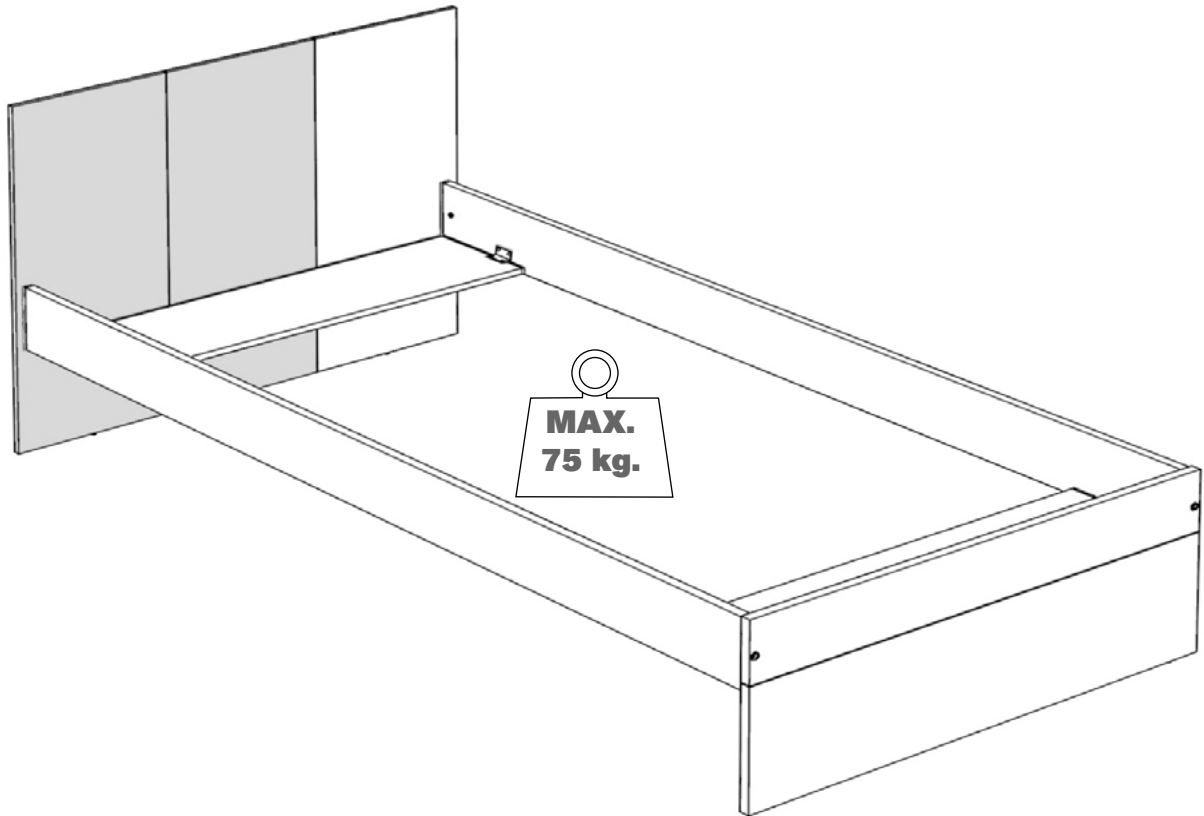
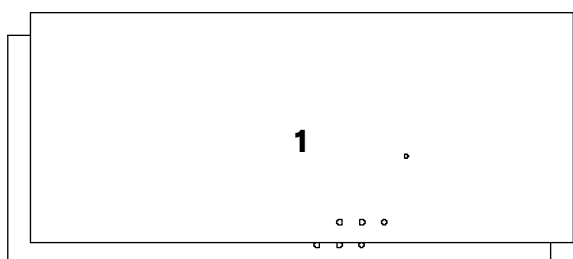
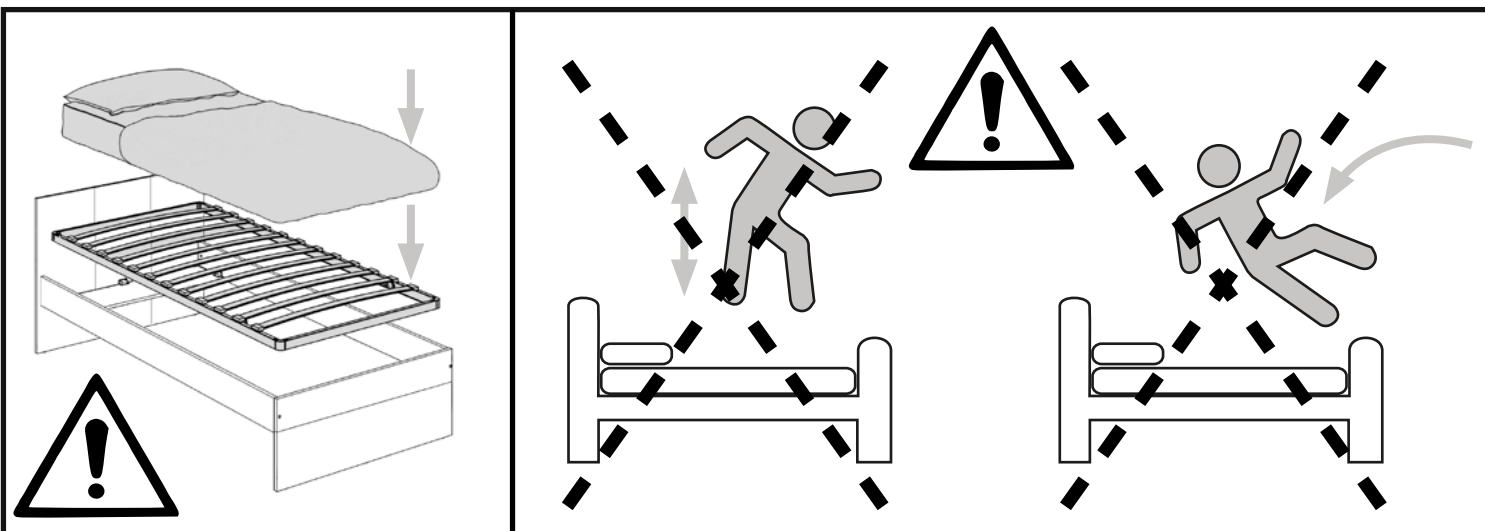
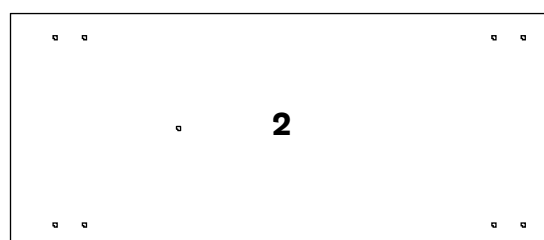

786 X 332 mm.

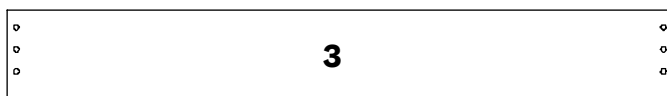

964 X 130 mm.

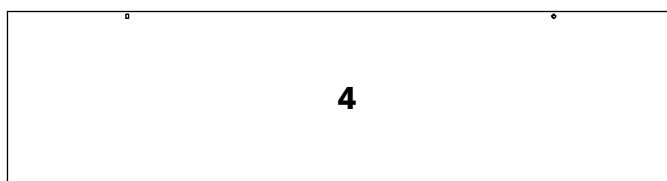

964 X 250 mm.

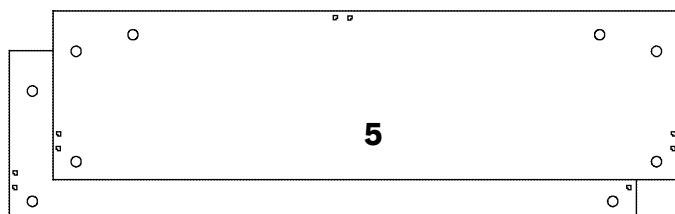

916 X 244 mm.

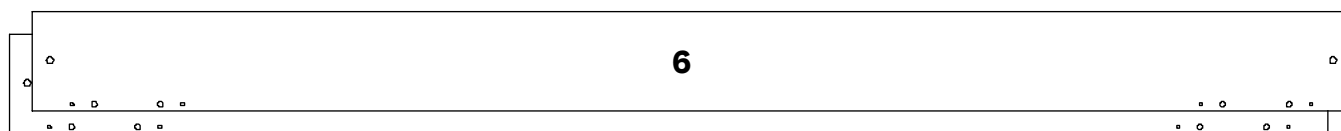

1911 X 144 mm.

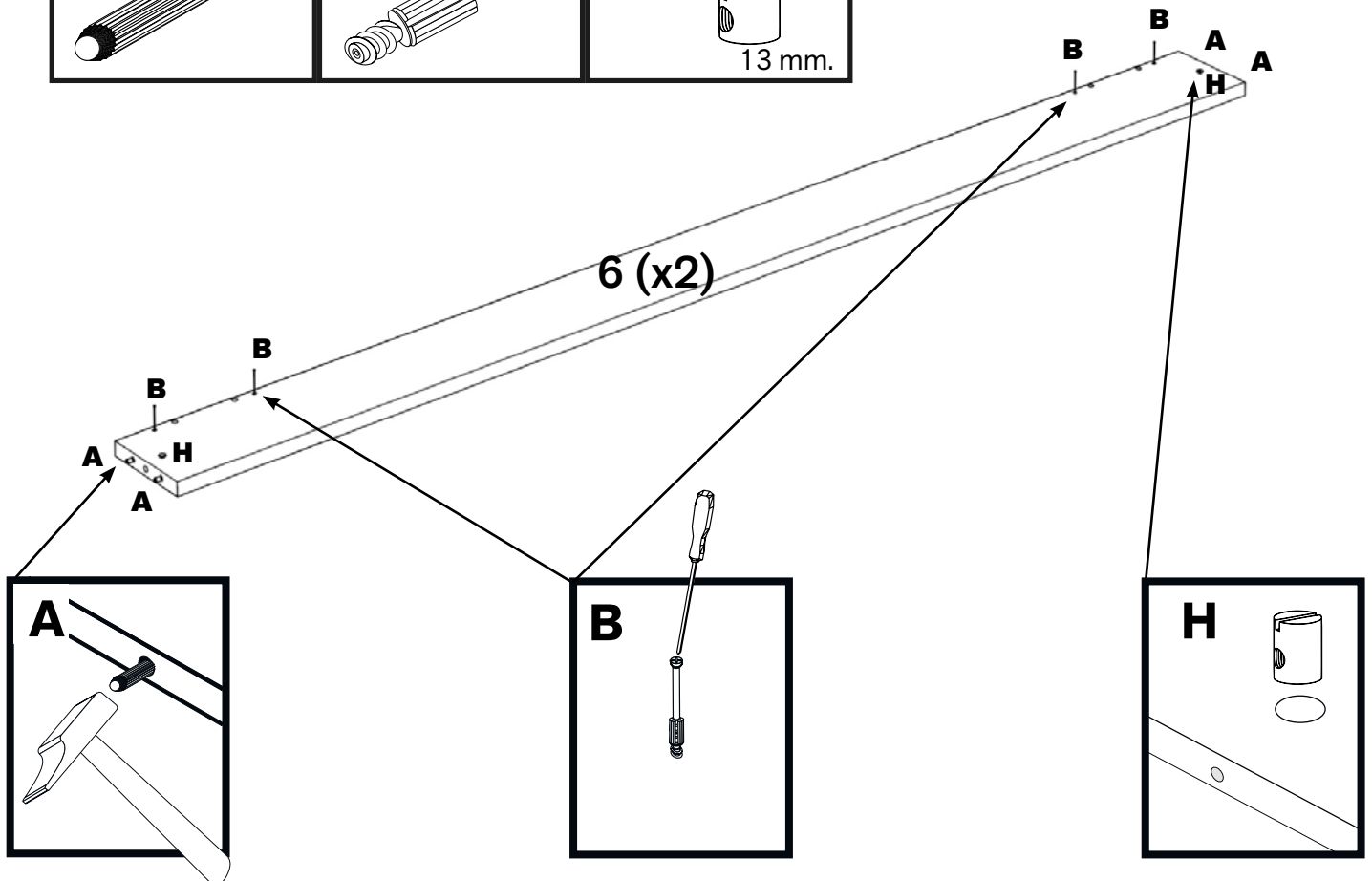
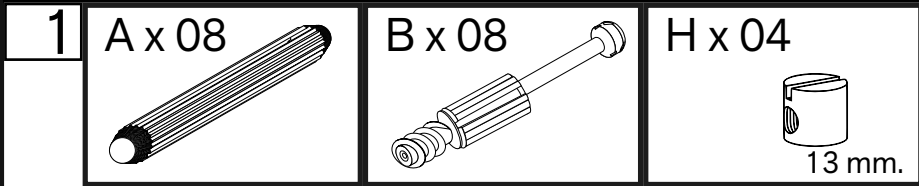
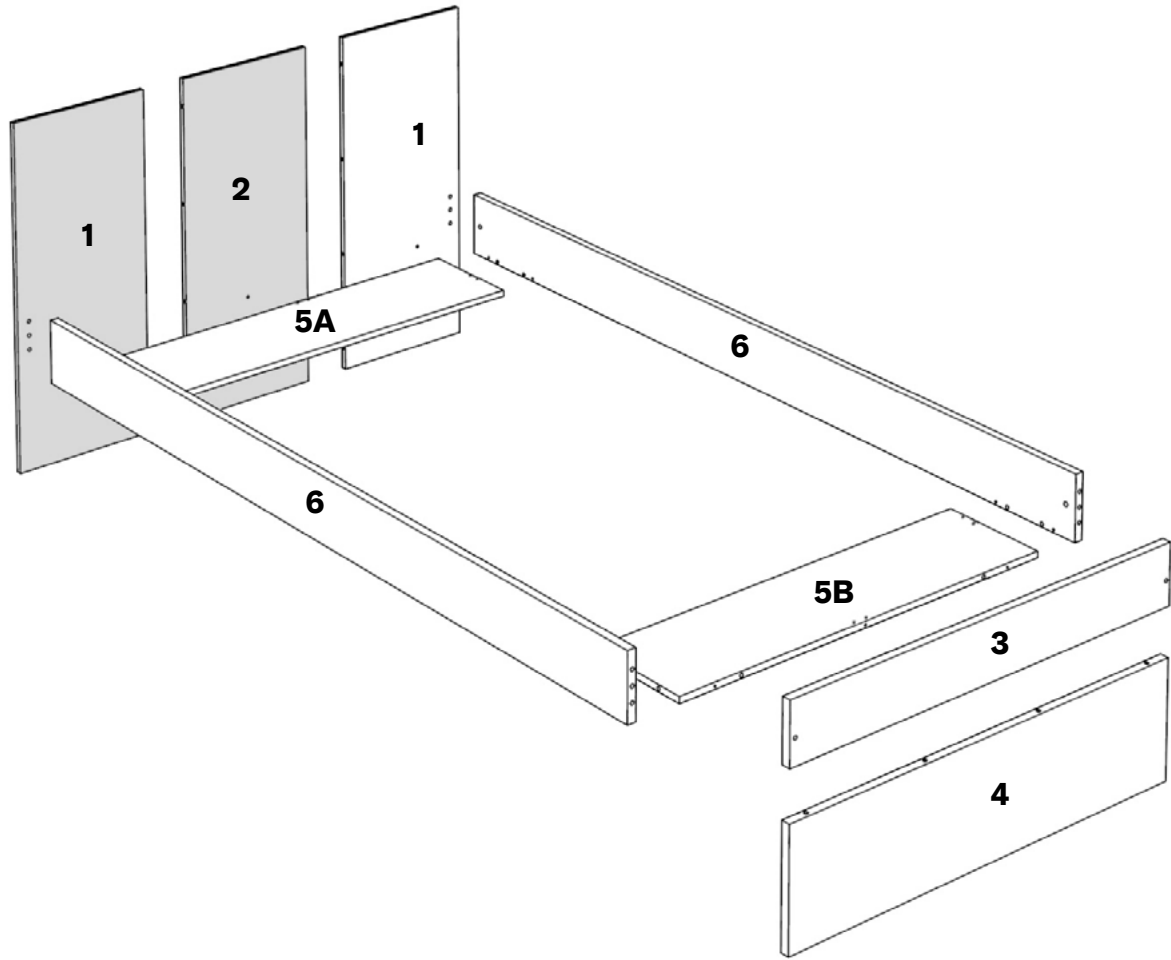

2

M x 05

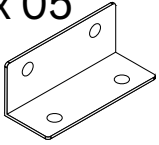

N x 10



M4 x 15 mm.

O x 10

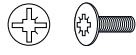

M4 x 10 mm.

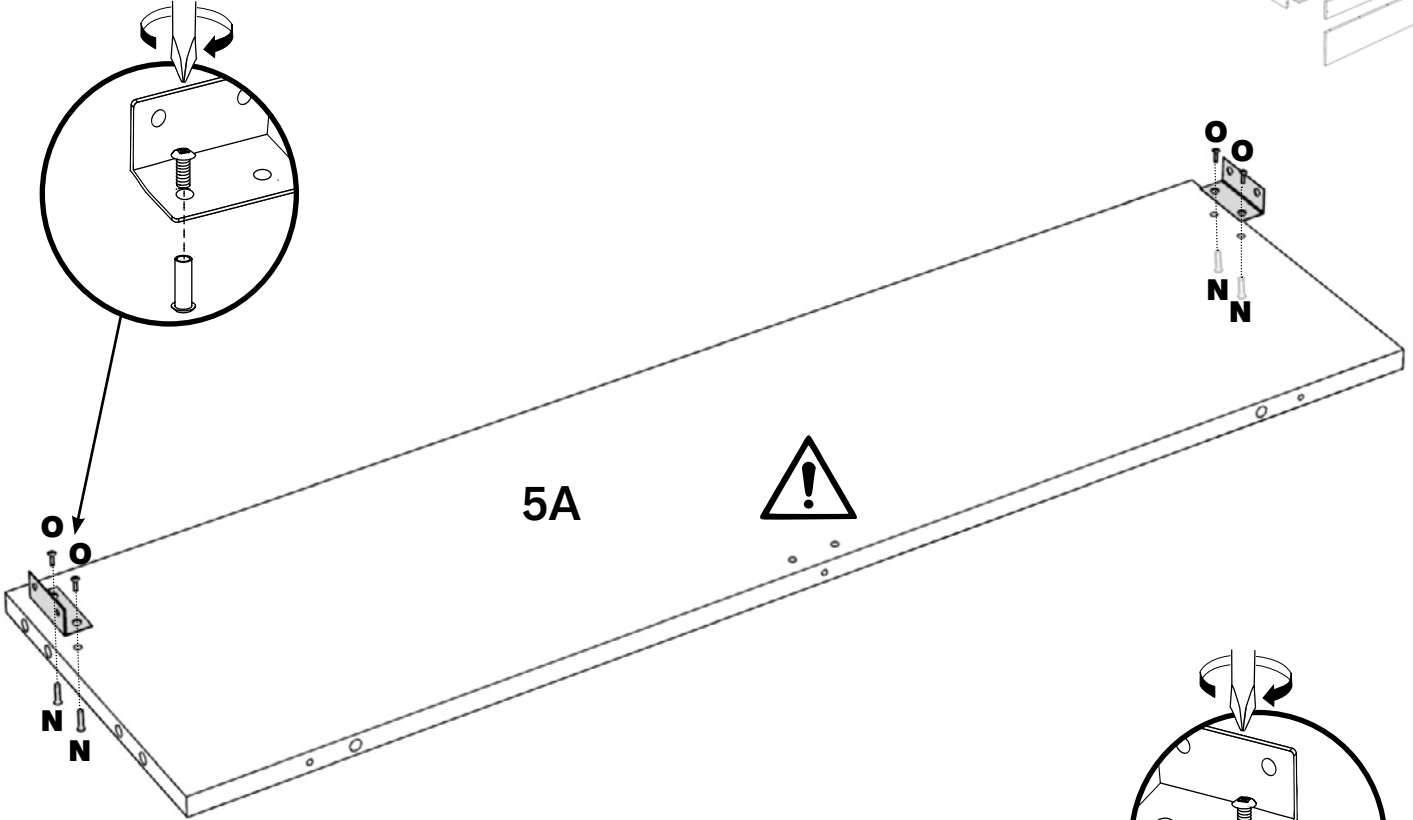
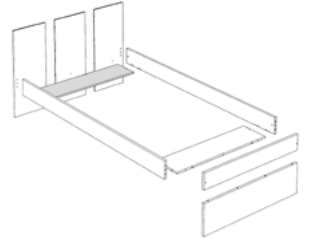

5A

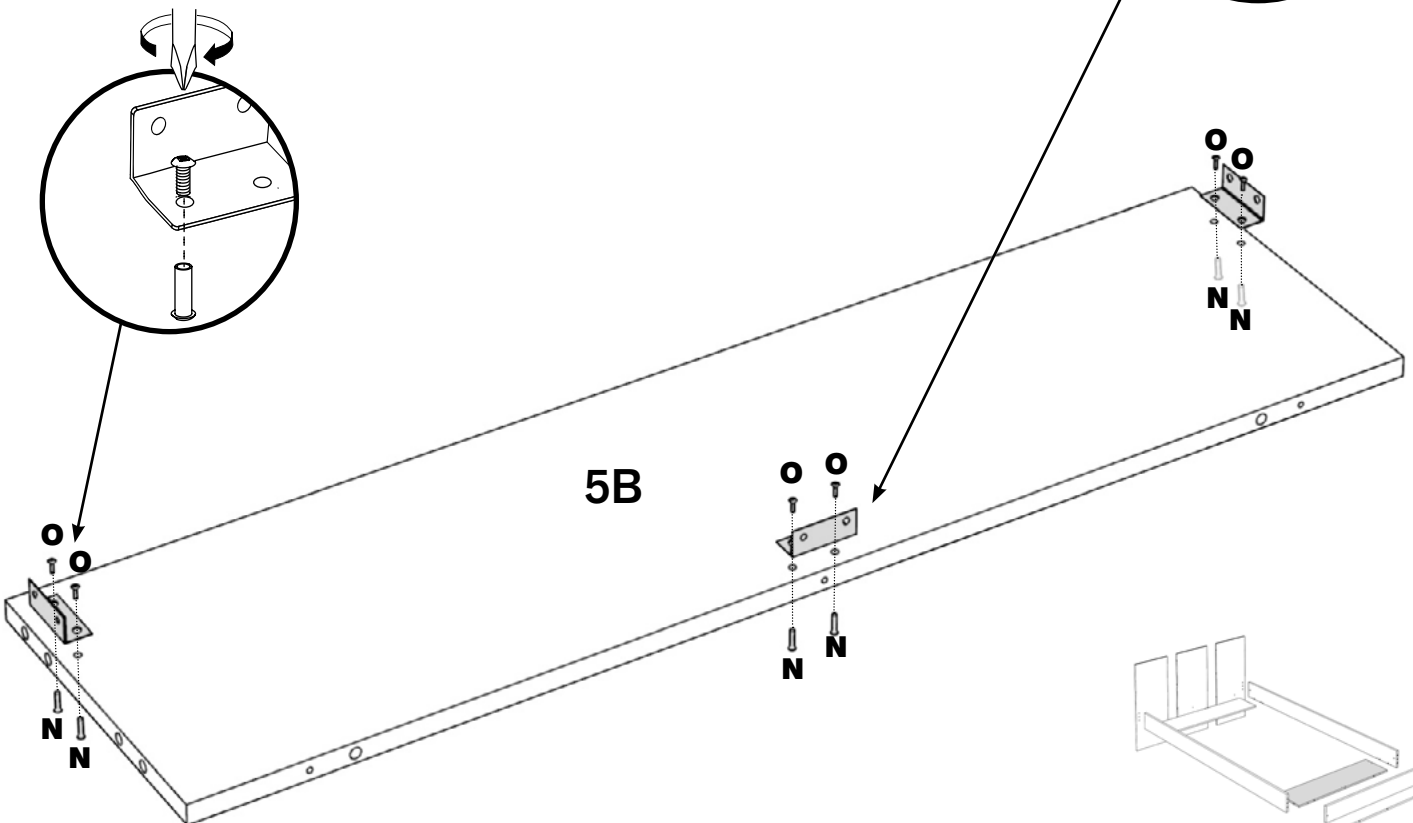

5B

3 C x 10

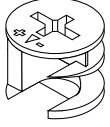

A x 08

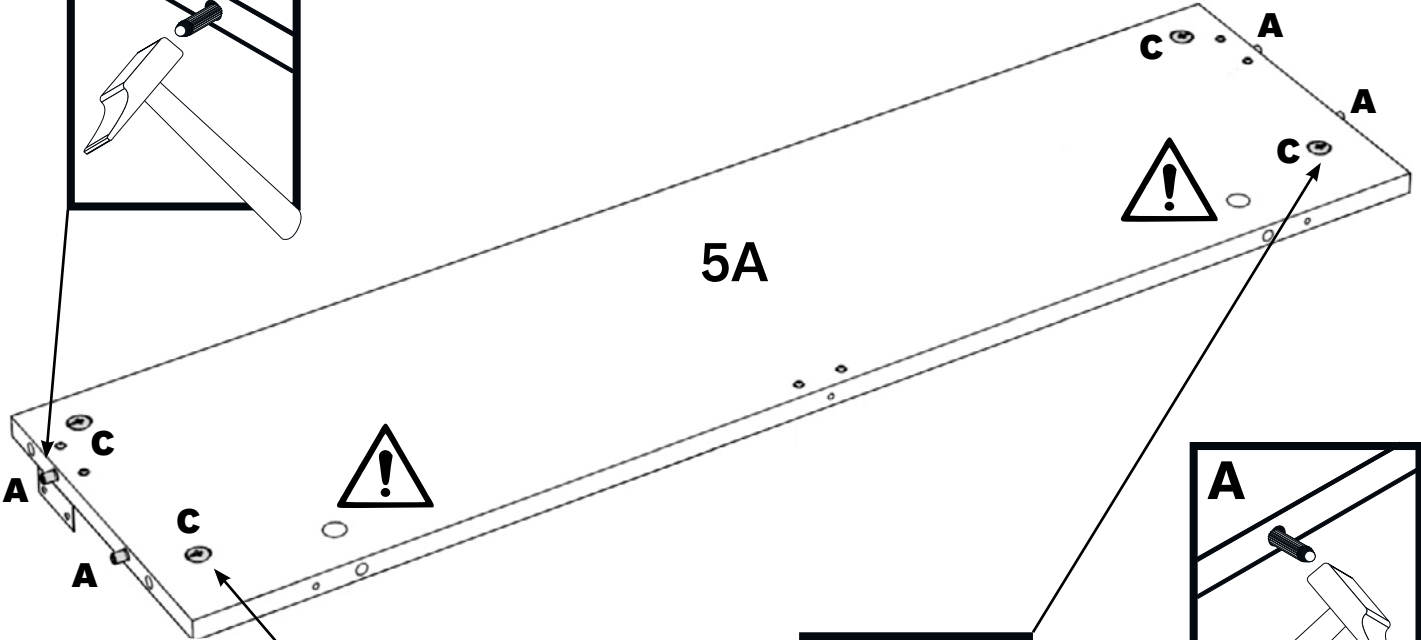
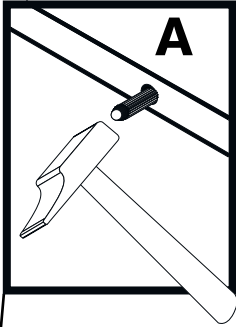
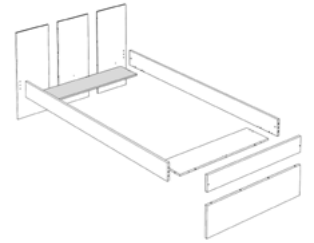
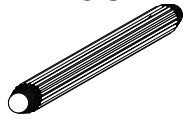

5A

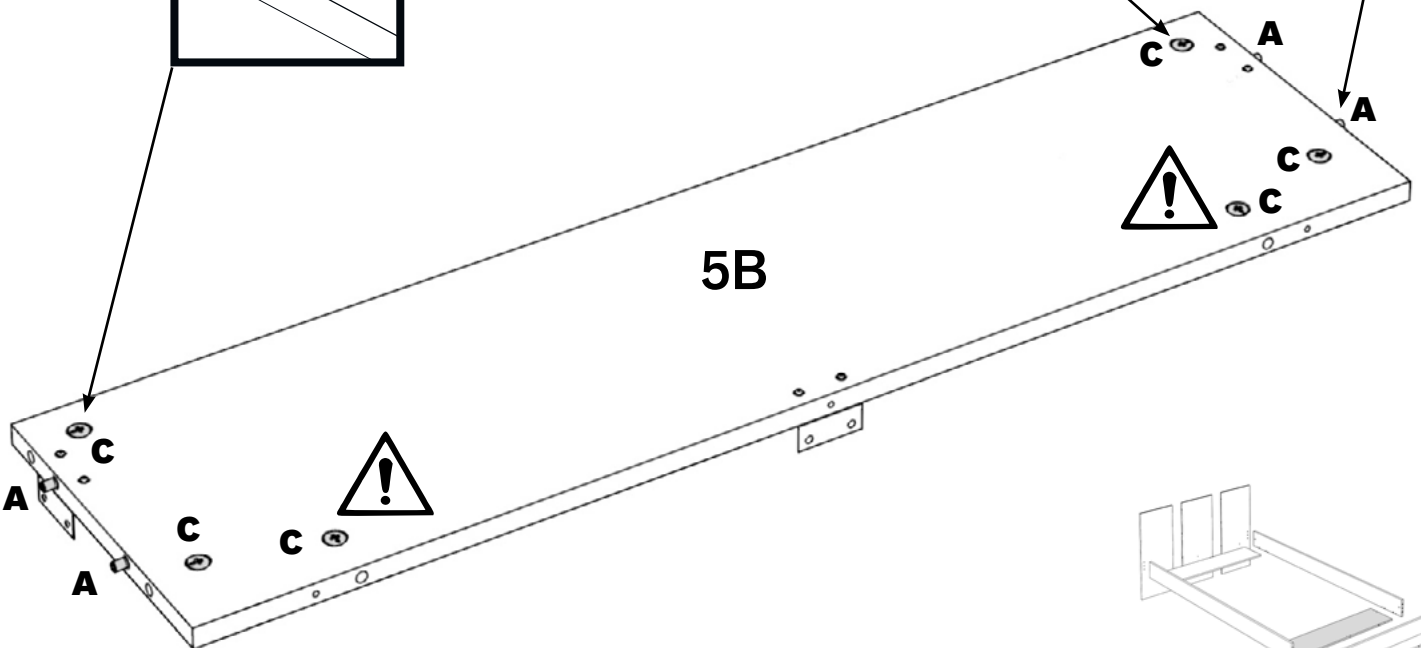
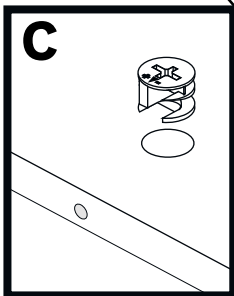
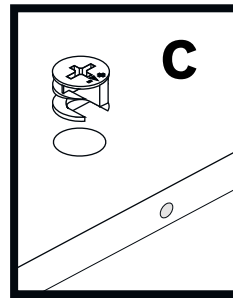
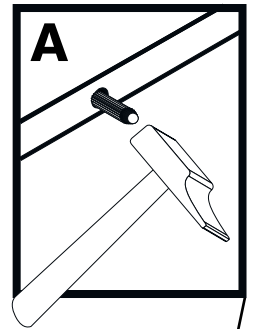

5B

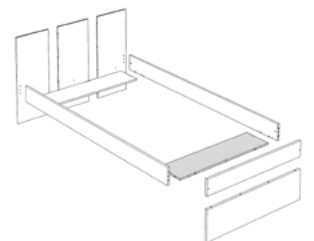

4

K x 01

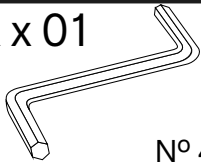

N° 4

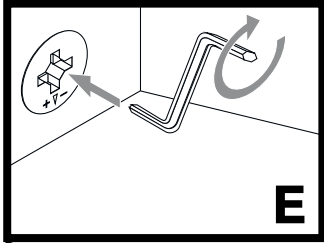
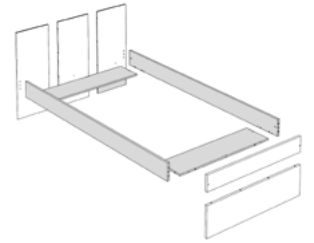

E

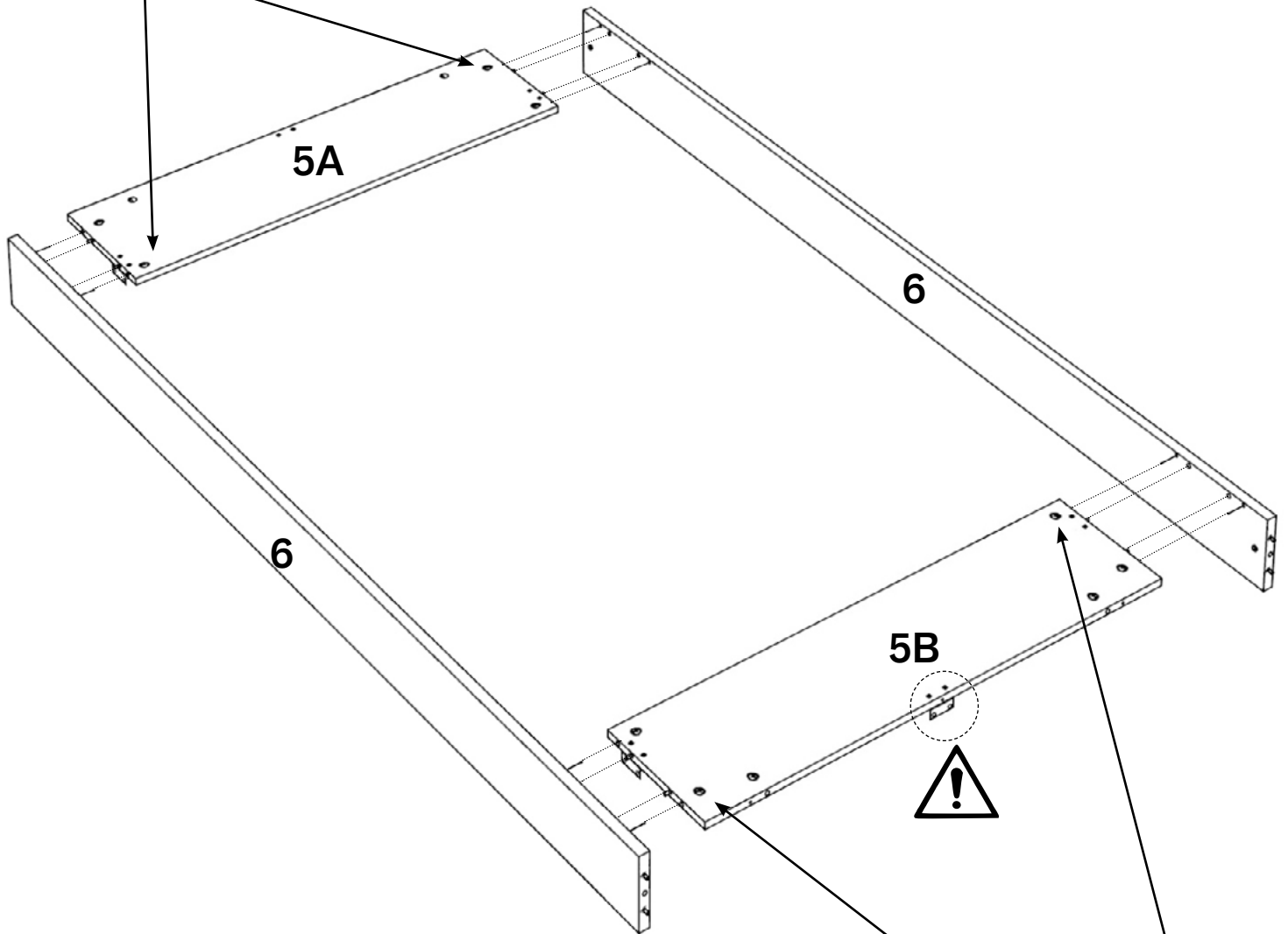

5B

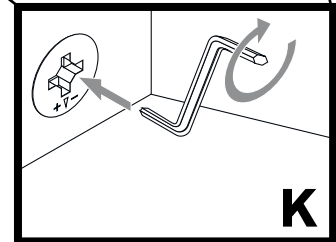
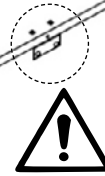

K

5 1 x 02

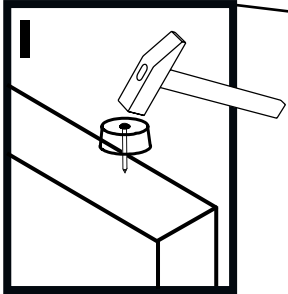
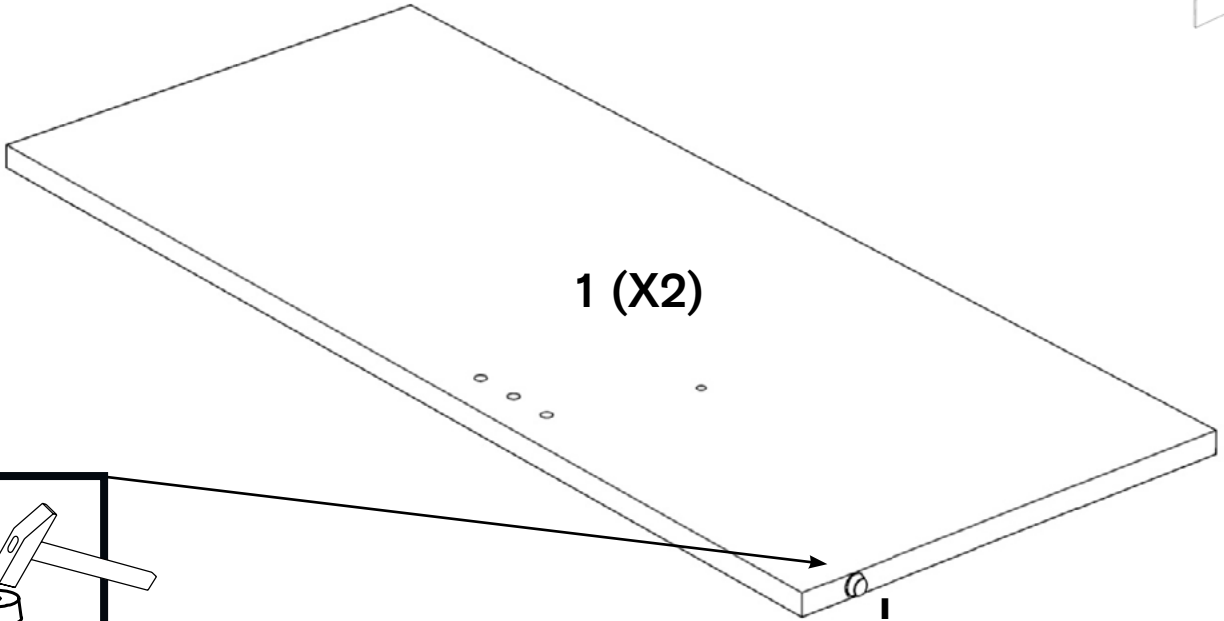
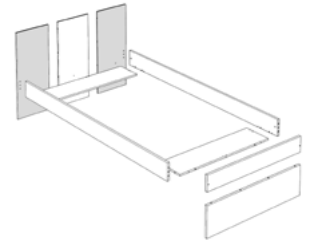
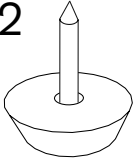

6 A x 08

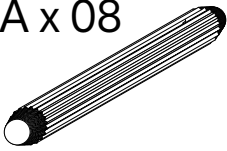

1 x 01

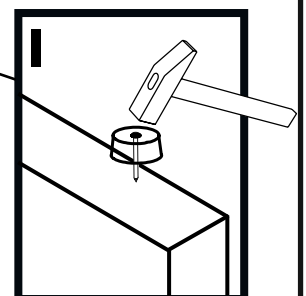
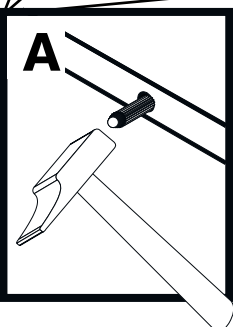
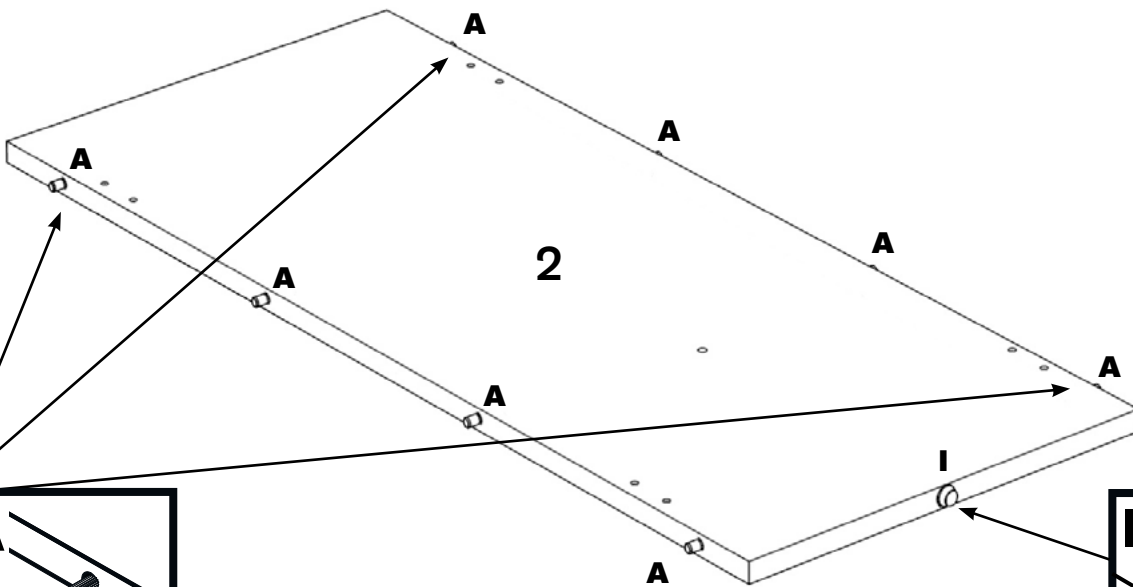
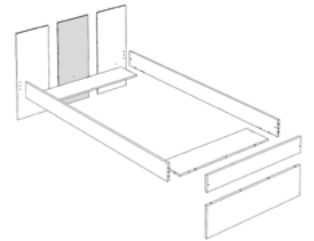
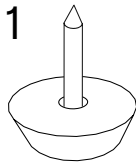

7

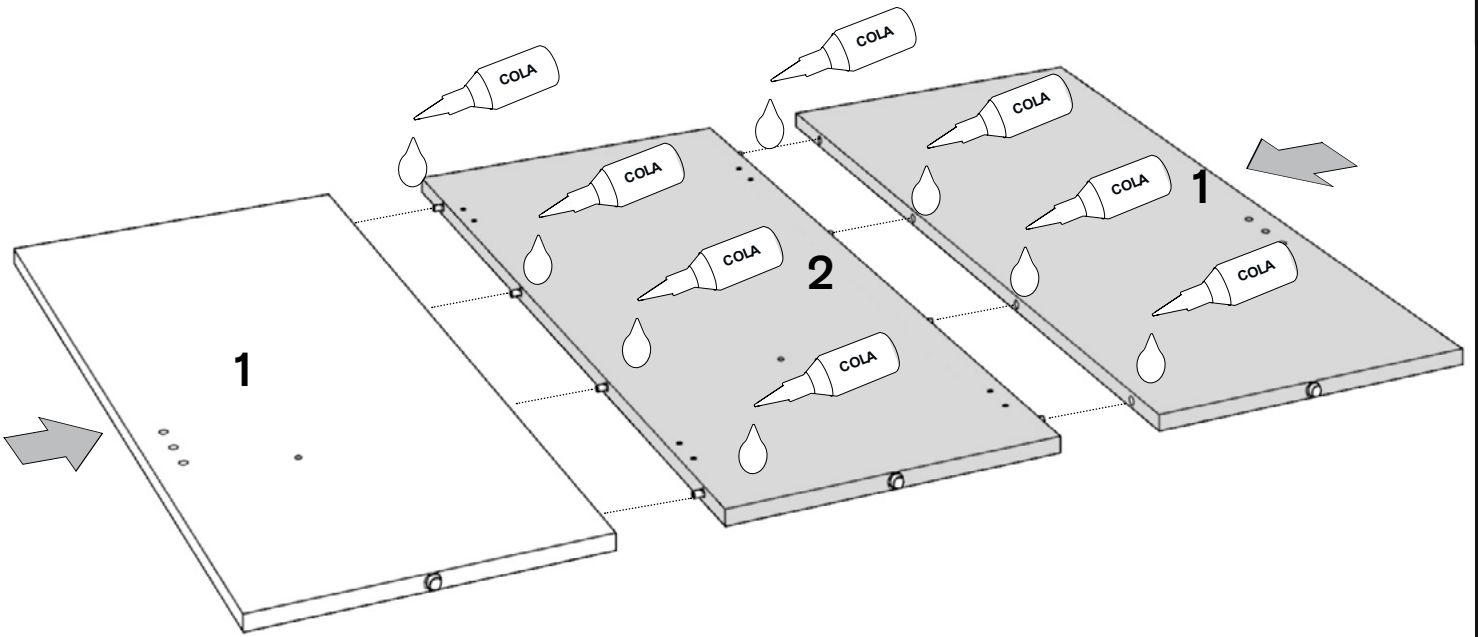

8

D x 04

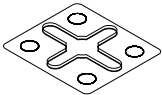

E x 16



3.5 x 15 mm.

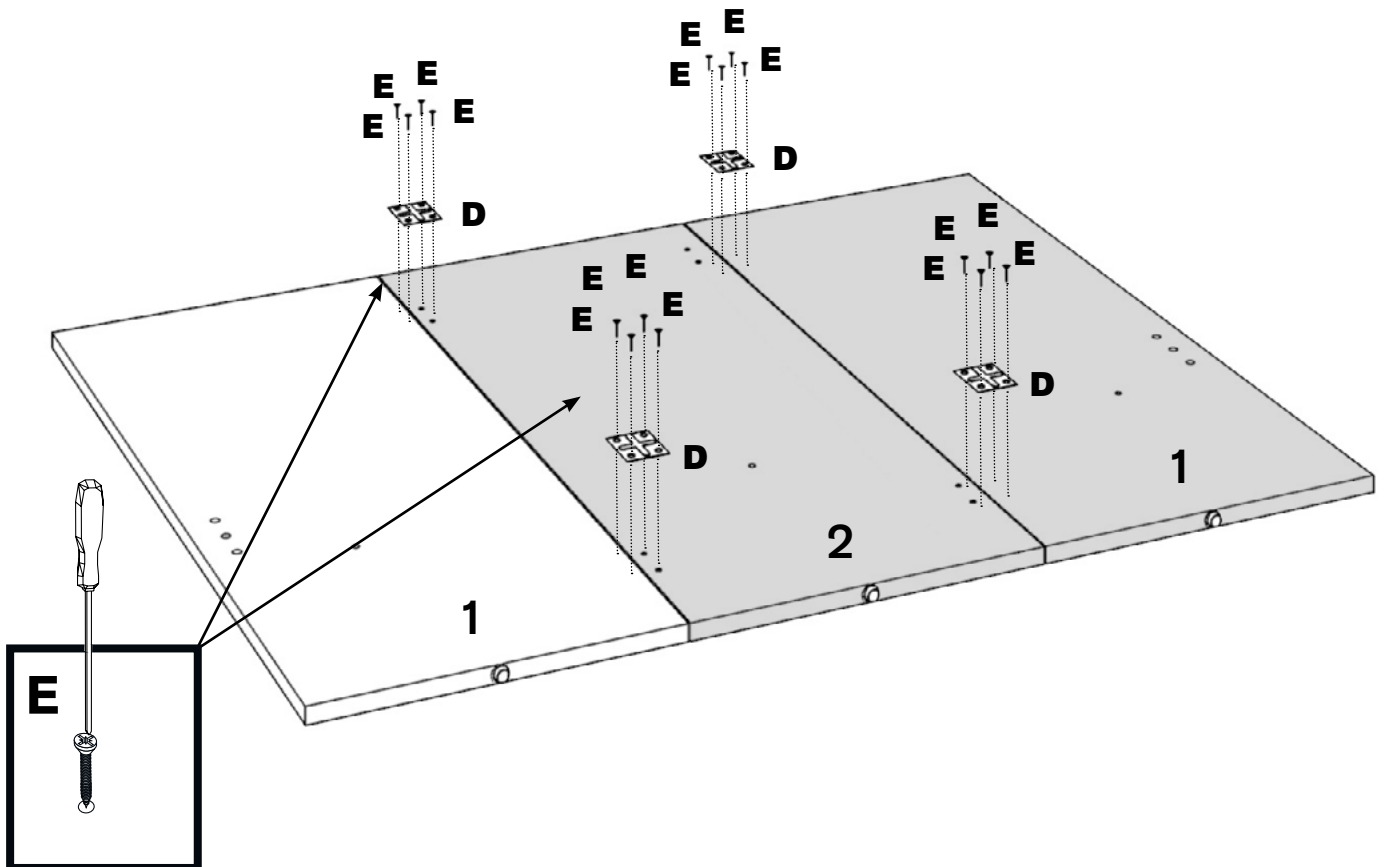

9

F x 02

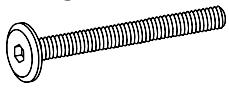

M6 x 60 mm.

G x 03



5 x 60 mm.

J x 01

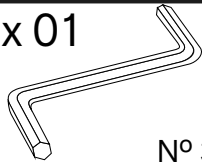

N° 3



5B

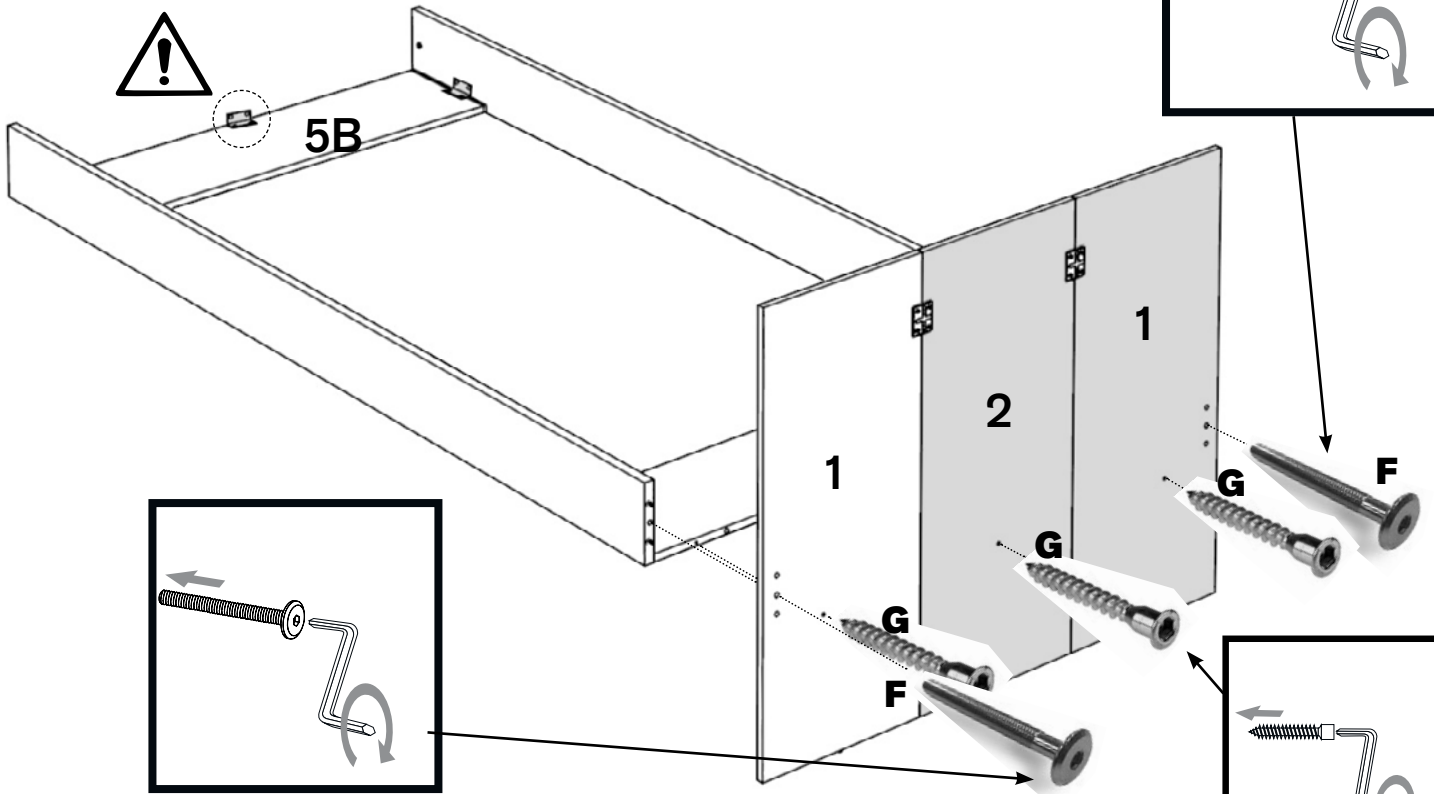
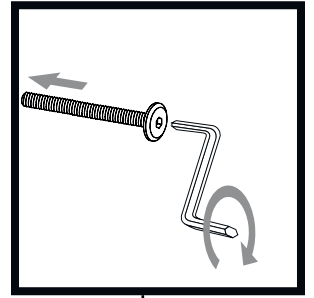

10

A x 04

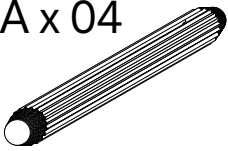

B x 02

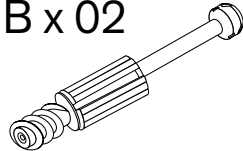

I x 03

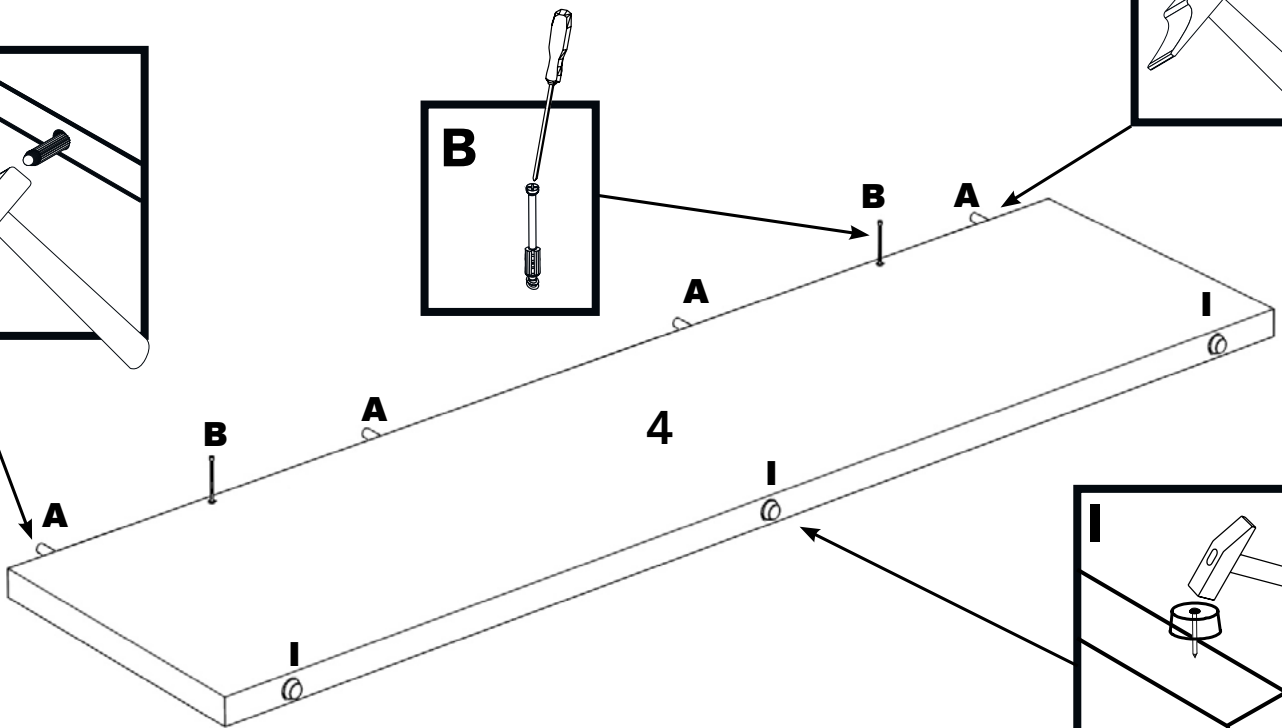
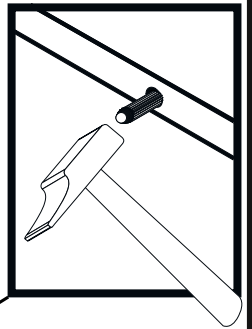
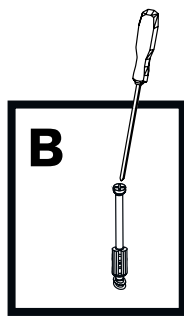
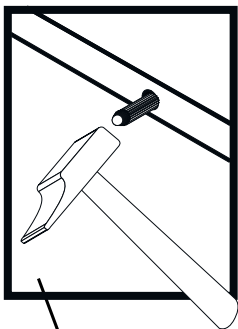
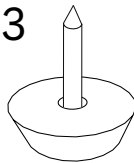

11

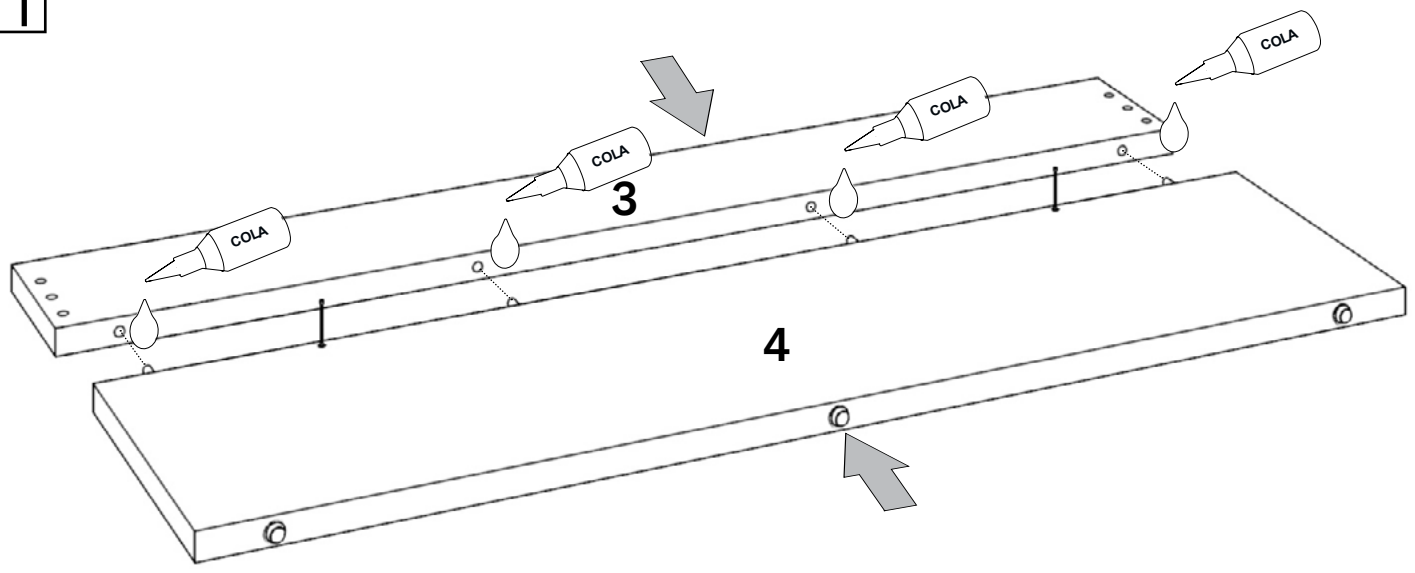

12

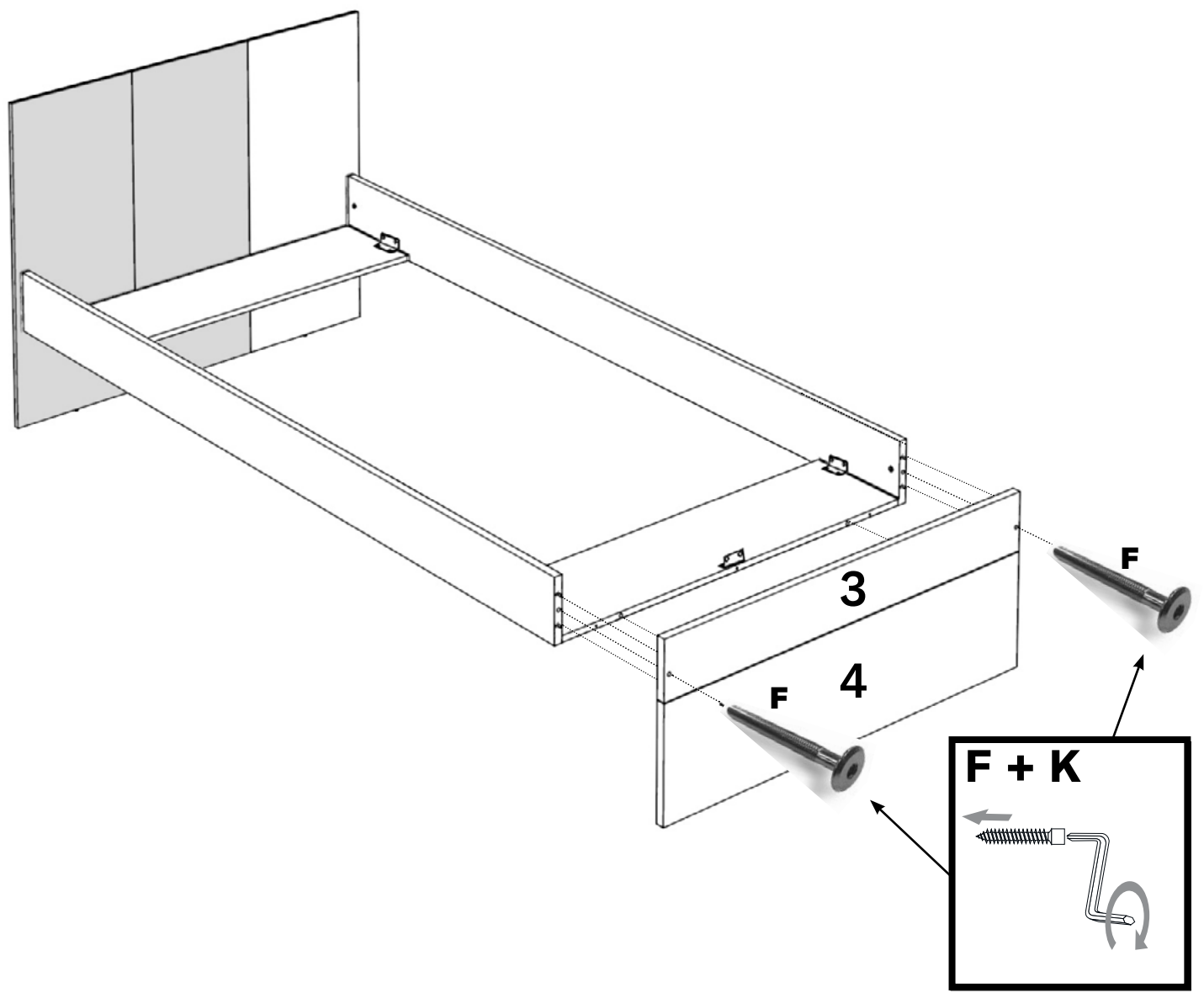
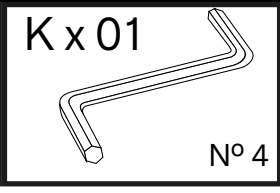
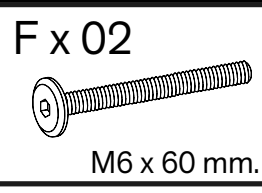

13

K x 01

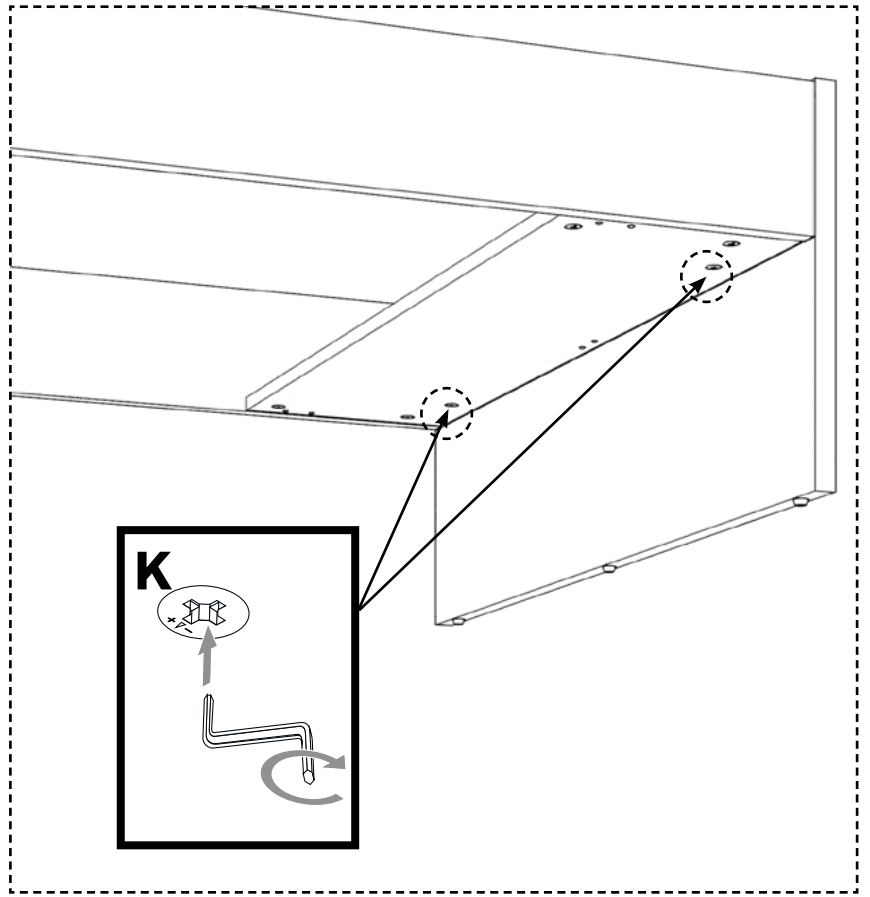
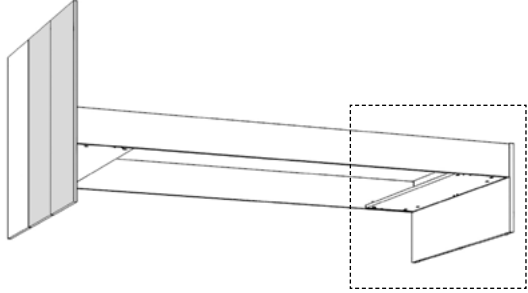
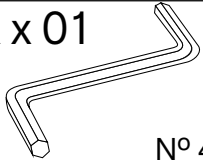

14

P x 10

