

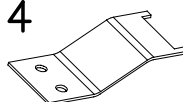

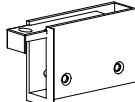

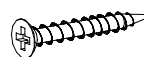

<p>A1</p>  <p>ø7x50 x10</p>	<p>U14</p>  <p>x2</p>	<p>U13</p>  <p>x2</p>	<p>G3</p>  <p>4x30 x4</p>	<p>G2</p>  <p>3x20 x25</p>
<p>B7</p>  <p>ø8x30 x20</p>	<p>W2</p>  <p>x1</p>	<p>W1</p>  <p>x1</p>	<p>U4</p>  <p>x4</p>	<p>GLUE, LEIM, LEPIDLO, LIM</p>  <p>x1</p>

1

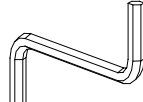

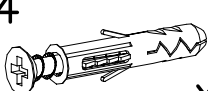
II

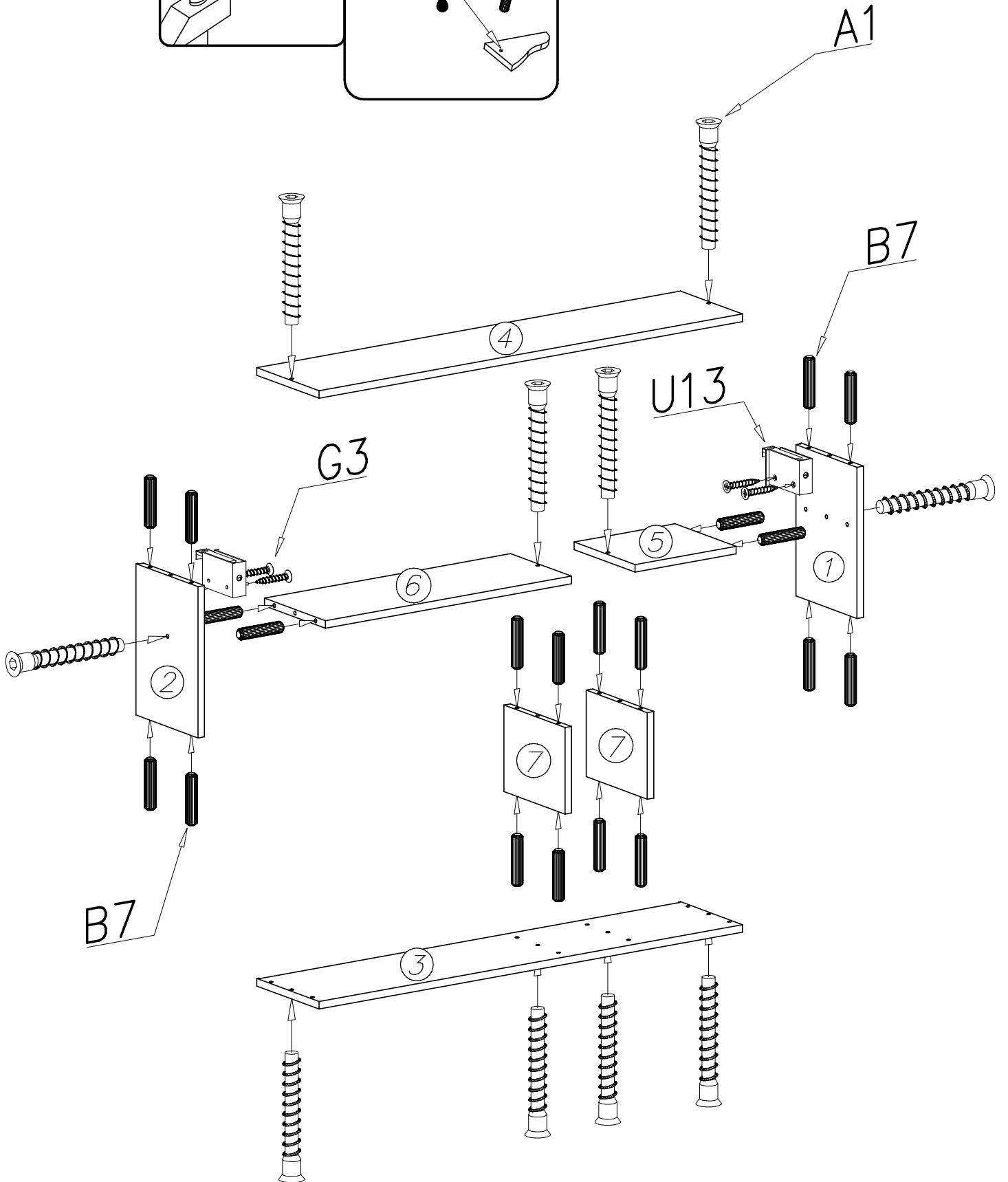
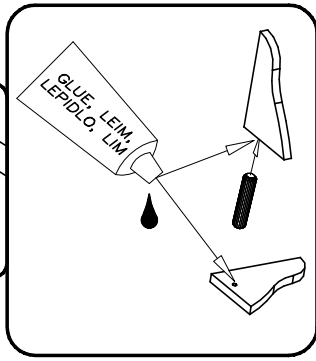
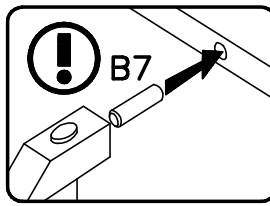
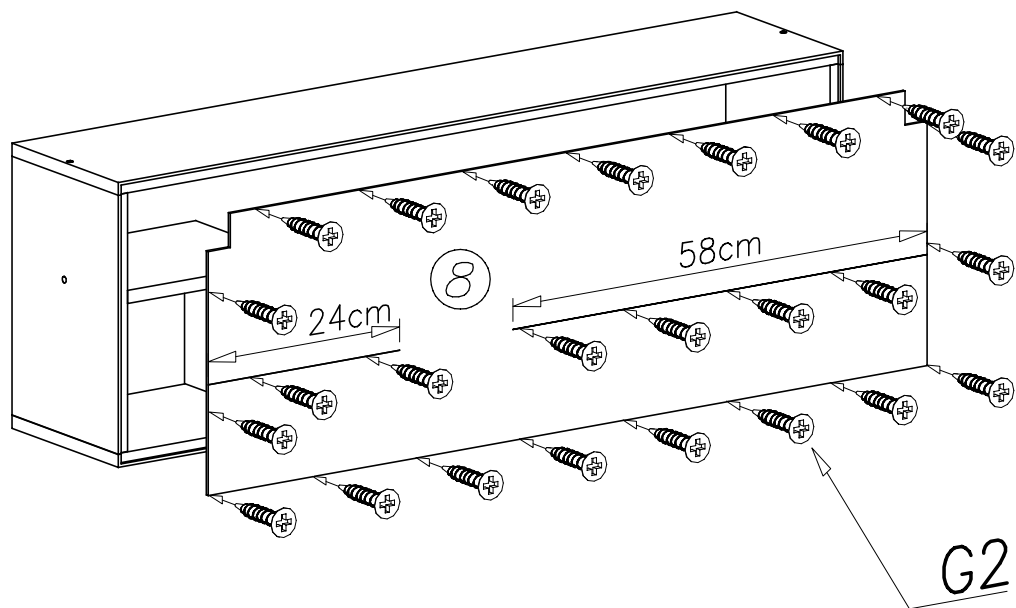

III

