

F-1	1531	395	16	x1	1/1
F-2	1531	395	16	x1	1/1
F-3	352	394	16	x1	1/1
F-4	352	394	16	x1	1/1
F-5	352	347	16	x1	1/1
F-6	352	347	16	x1	1/1
F-7	482	335	16	x1	1/1
F-8	496	346	18	x1	1/1
F-9	496	346	16	x1	1/1
F-10	1512	366	3	x1	1/1

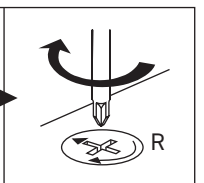

1

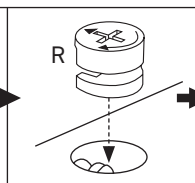
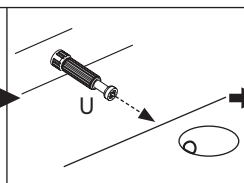
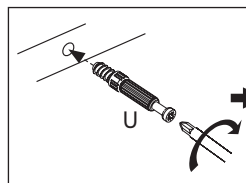
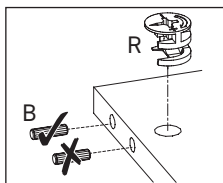
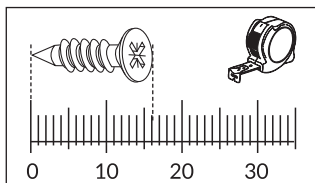
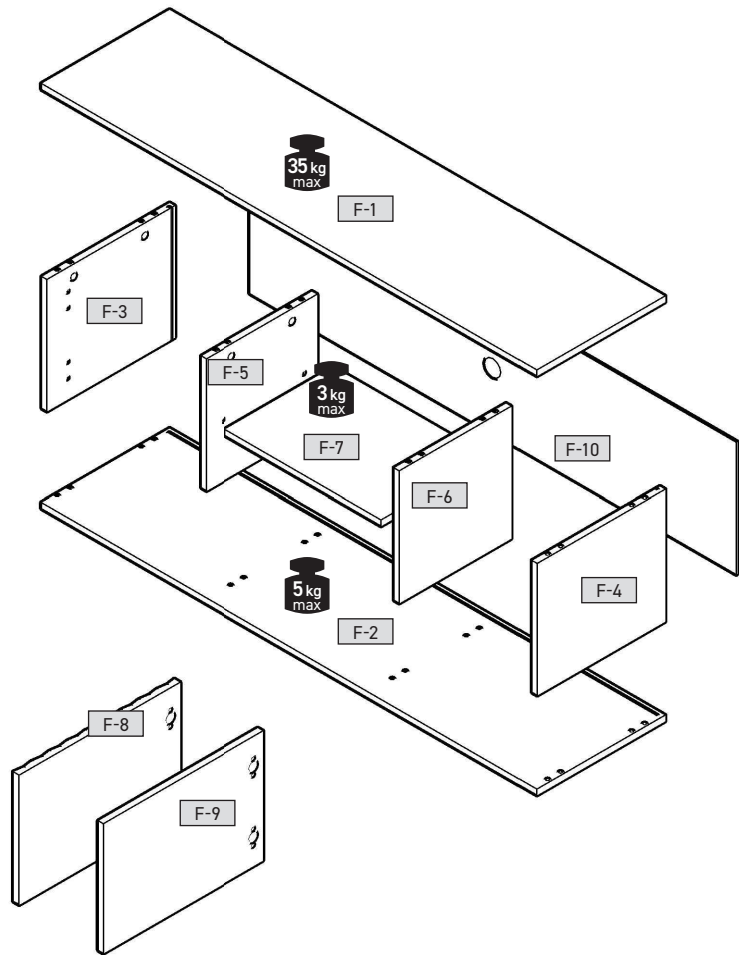
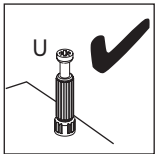
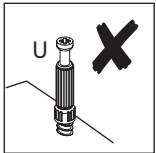
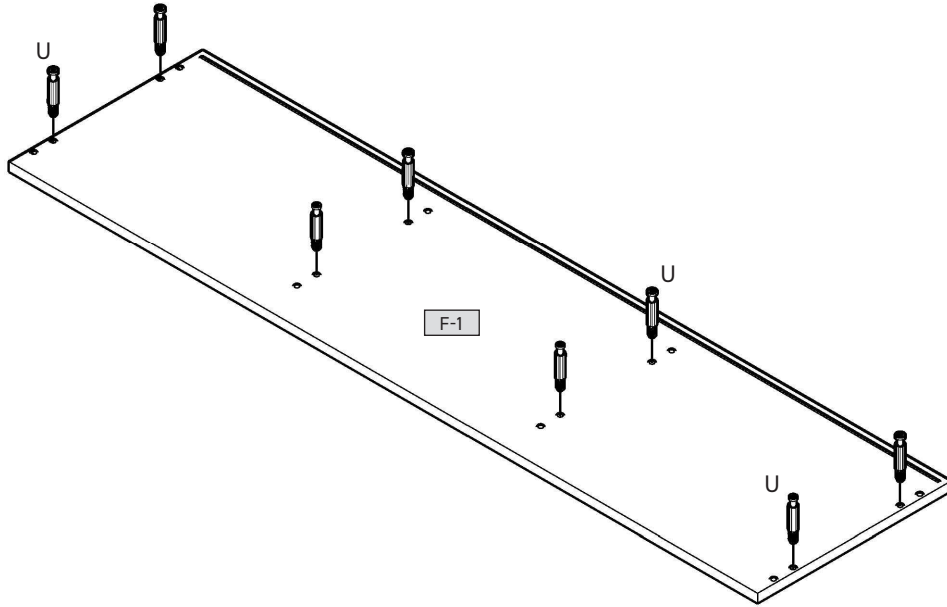
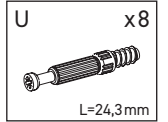

2

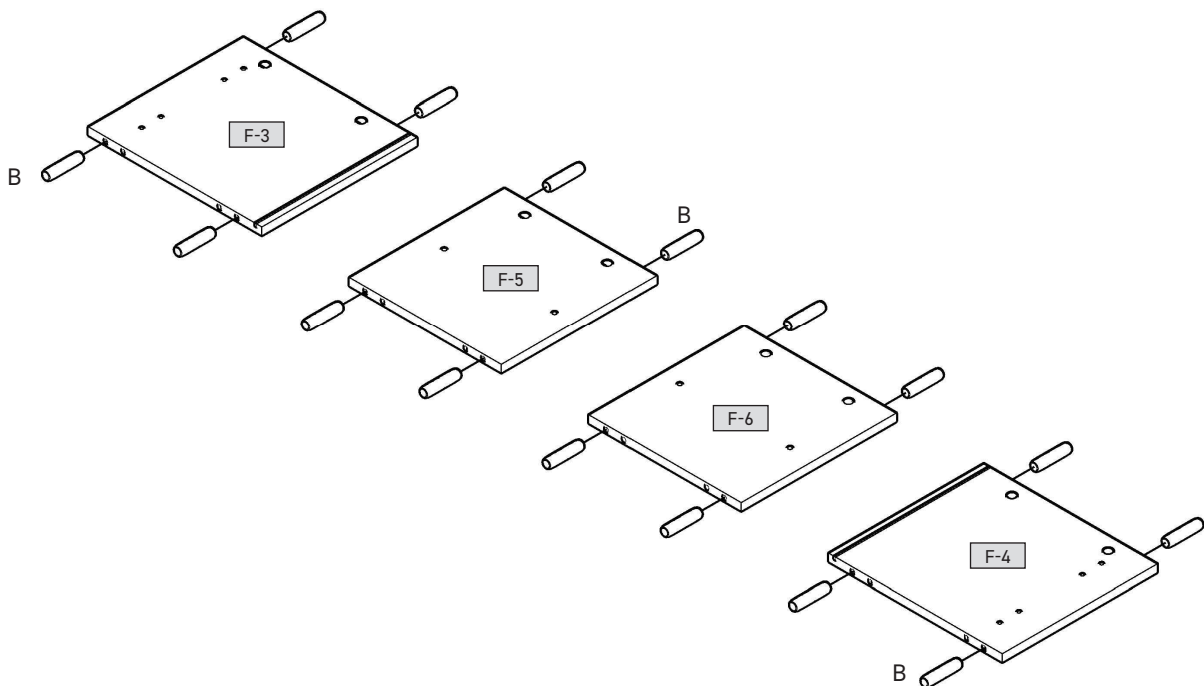
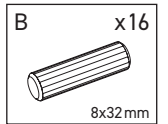

3

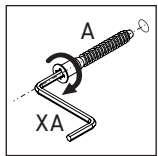
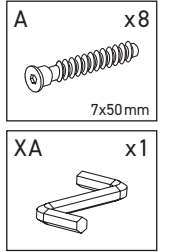
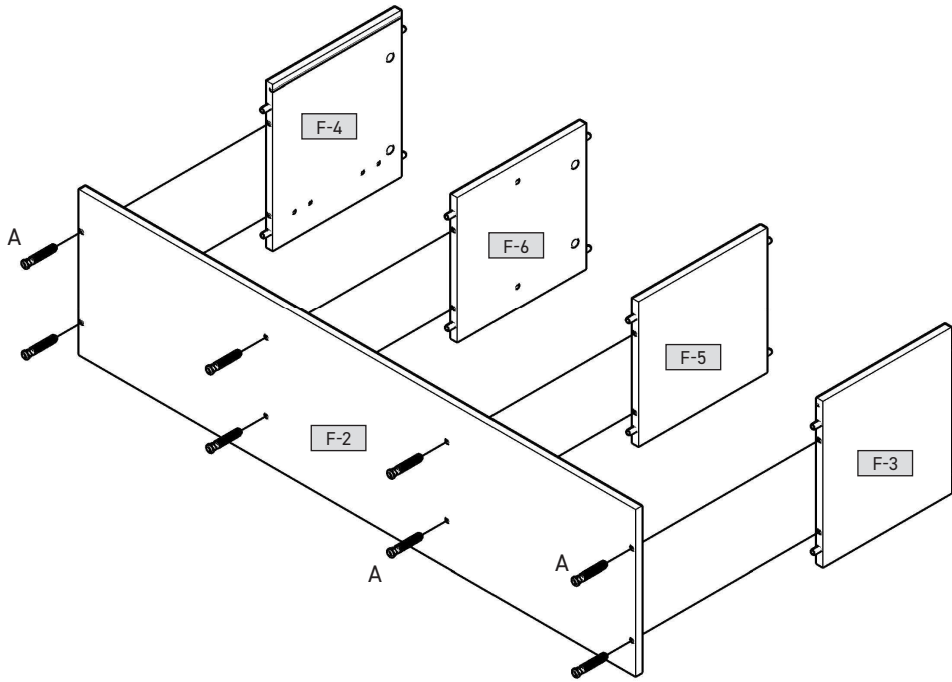

4

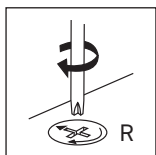
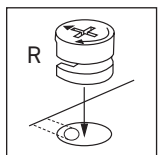
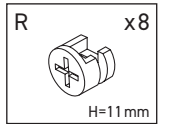
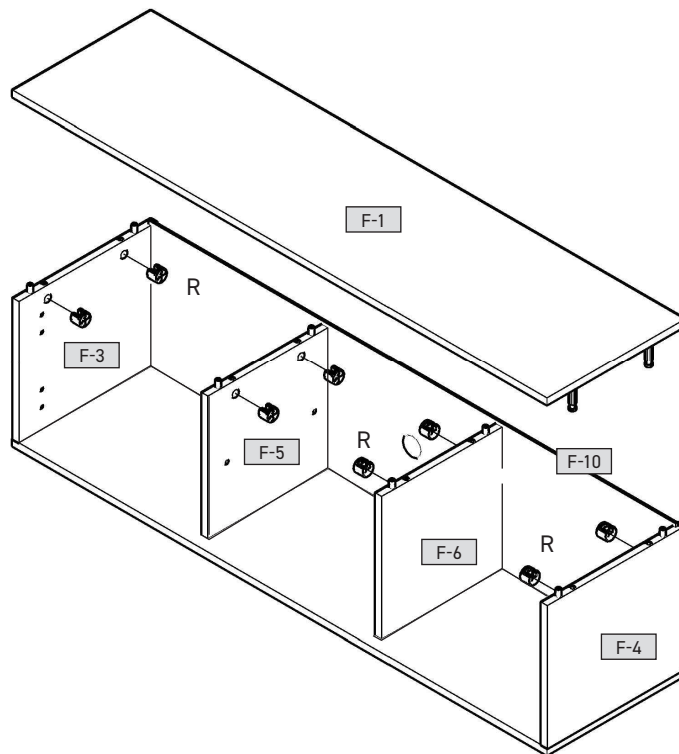

# 5

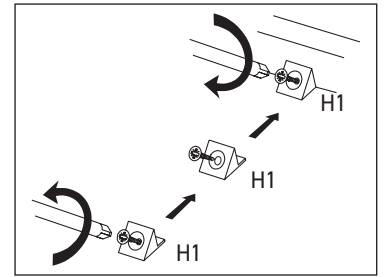
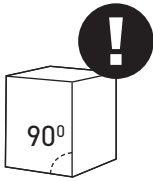
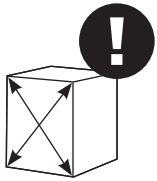
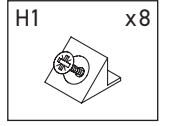
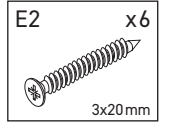
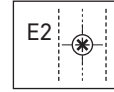
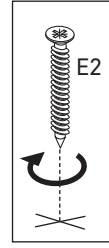
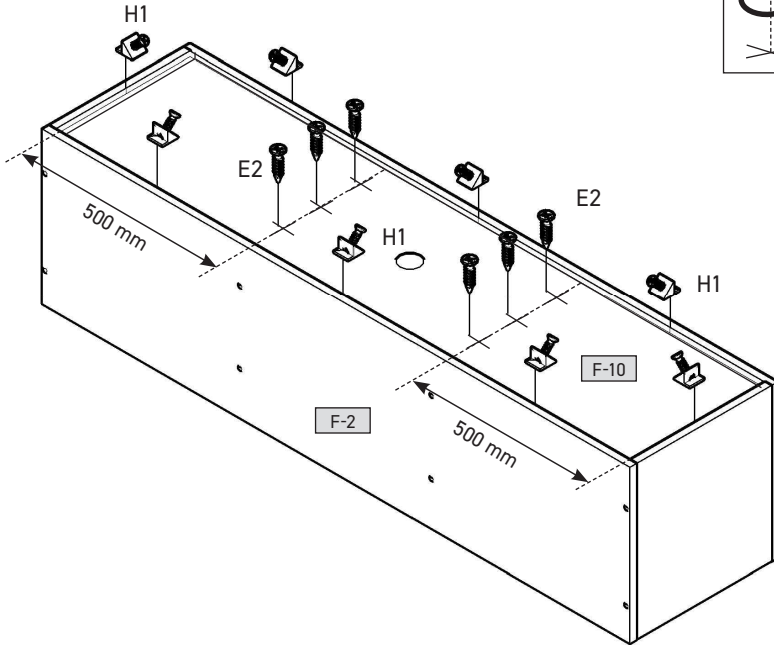

# 6

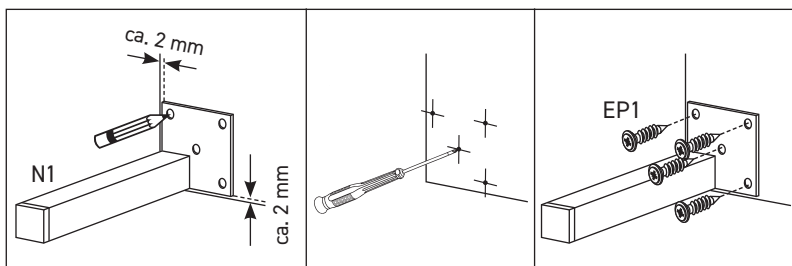
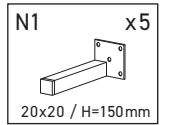
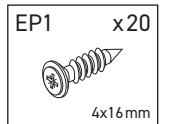
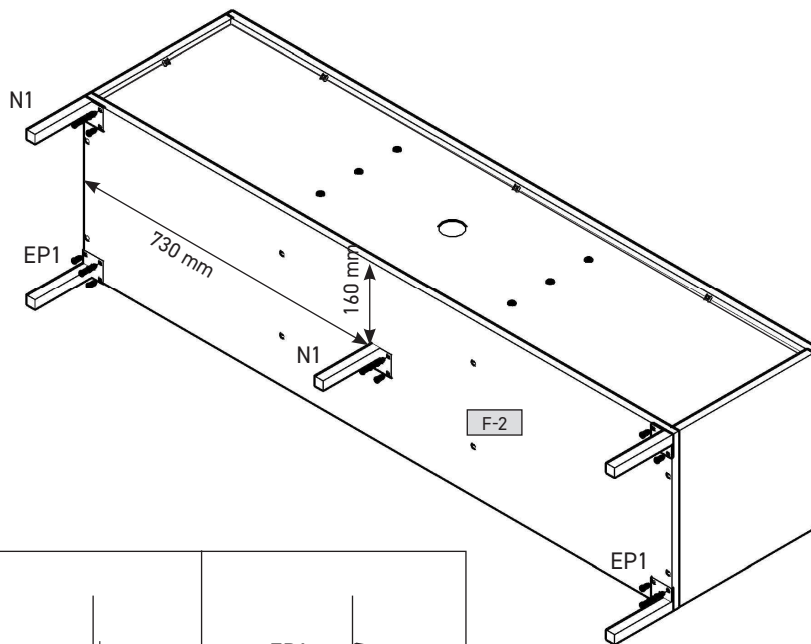

7

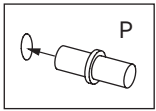
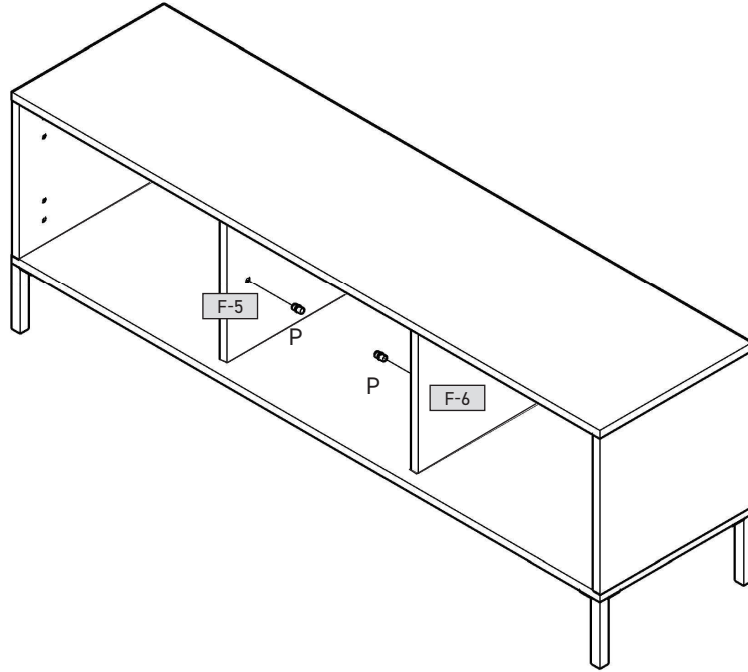
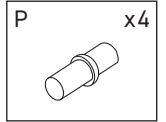
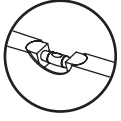

8

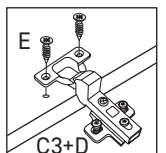
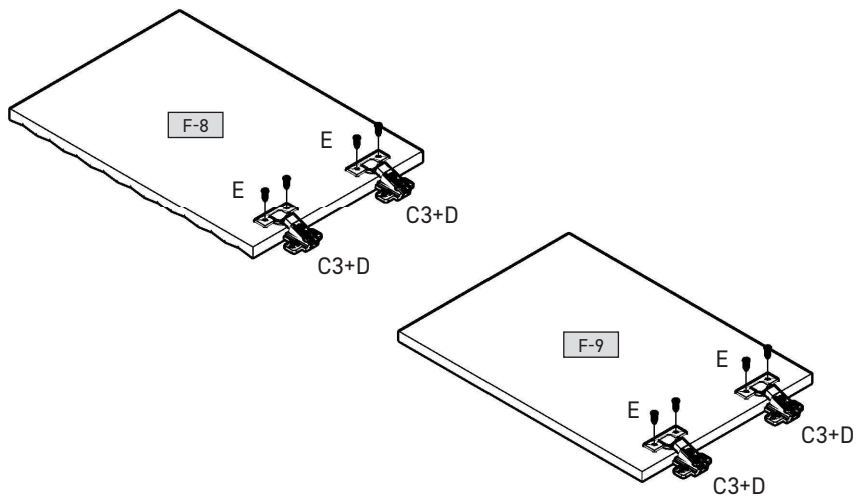
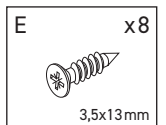
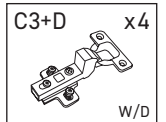

9

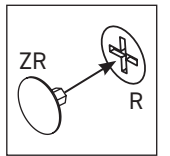
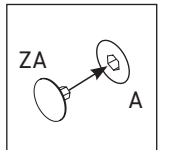
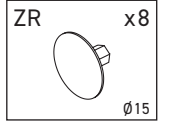
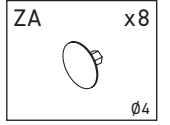
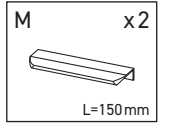
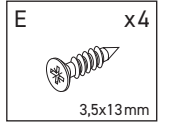
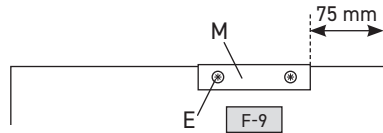
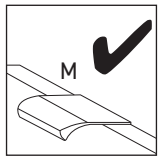
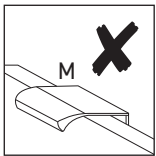
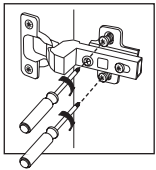
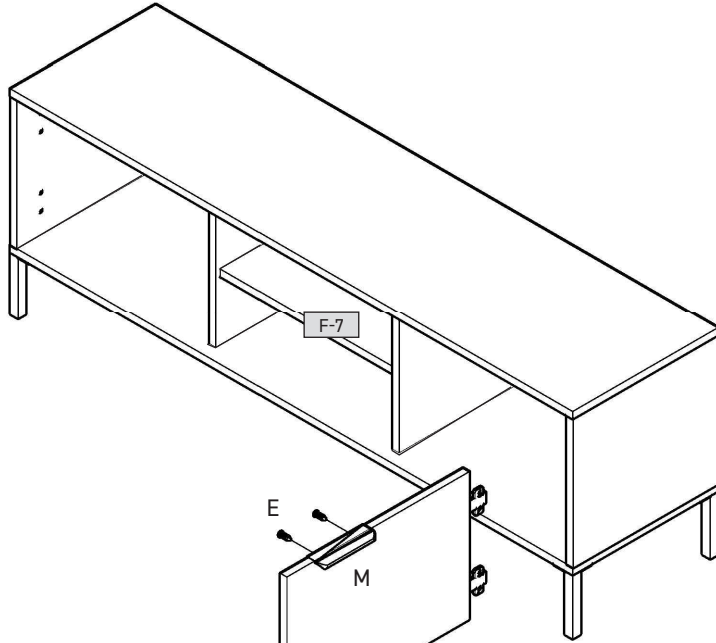
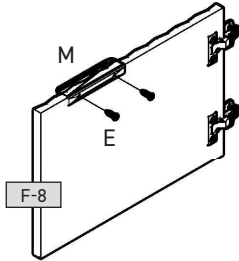
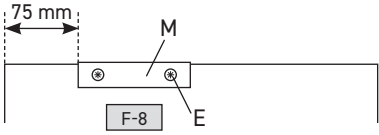

10

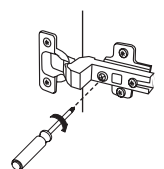
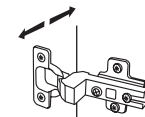
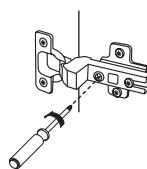
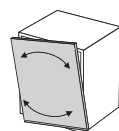
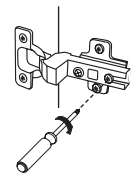
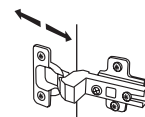
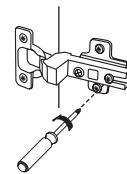
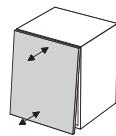
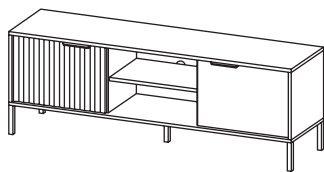
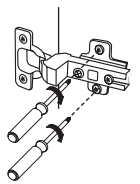
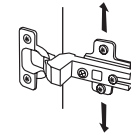
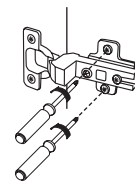
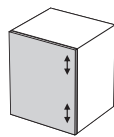



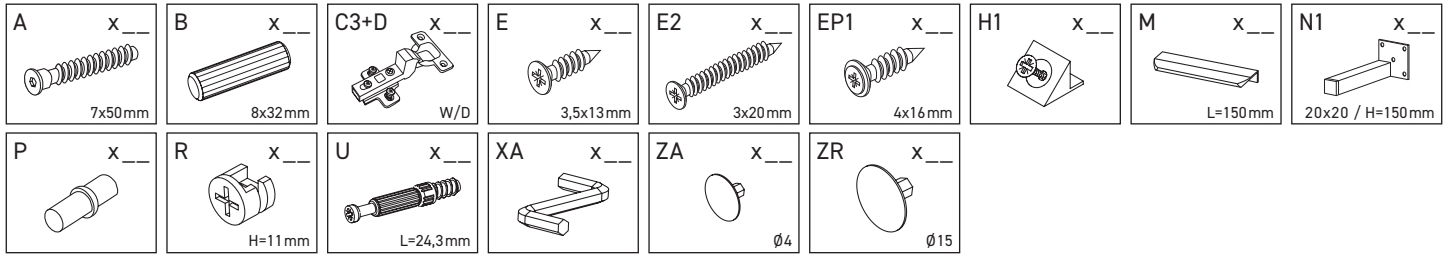

F-1	1531	395	16	x 1	1/1
F-2	1531	395	16	x 1	1/1
F-3	352	394	16	x 1	1/1
F-4	352	394	16	x 1	1/1
F-5	352	347	16	x 1	1/1
F-6	352	347	16	x 1	1/1
F-7	482	335	16	x 1	1/1
F-8	496	346	18	x 1	1/1
F-9	496	346	16	x 1	1/1
F-10	1512	366	3	x 1	1/1

