

| | | | | | |
|------|------|------|----|-----|-----|
| A-1 | 2080 | 520 | 16 | x 1 | 1/4 |
| A-2 | 2080 | 520 | 16 | x 1 | 1/4 |
| A-3 | 1968 | 505 | 16 | x 1 | 3/4 |
| A-4 | 1968 | 505 | 16 | x 1 | 3/4 |
| A-5 | 1968 | 178 | 16 | x 1 | 2/4 |
| A-6 | 2168 | 505 | 16 | x 1 | 2/4 |
| A-7 | 2168 | 505 | 16 | x 1 | 2/4 |
| A-8 | 2168 | 80 | 16 | x 2 | 2/4 |
| A-9 | 991 | 505 | 16 | x 2 | 1/4 |
| A-10 | 661 | 489 | 16 | x 2 | 3/4 |
| A-11 | 661 | 489 | 16 | x 2 | 1/4 |
| A-12 | 484 | 489 | 16 | x 2 | 3/4 |
| A-13 | 484 | 489 | 16 | x 2 | 3/4 |
| A-14 | 504 | 2000 | 16 | x 4 | 4/4 |
| A-15 | 2000 | 24 | 18 | x 4 | 2/4 |
| A-16 | 1006 | 1998 | 3 | x 1 | 1/4 |
| A-17 | 500 | 1998 | 3 | x 1 | 2/4 |
| A-18 | 676 | 1998 | 3 | x 1 | 2/4 |

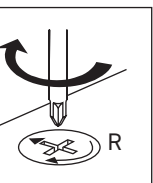

1

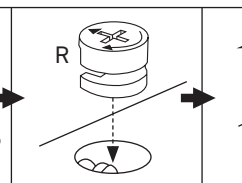
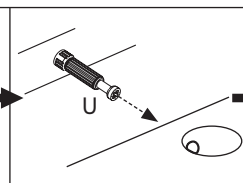
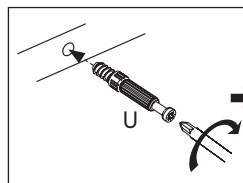
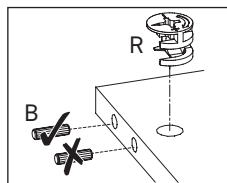
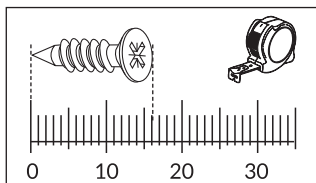
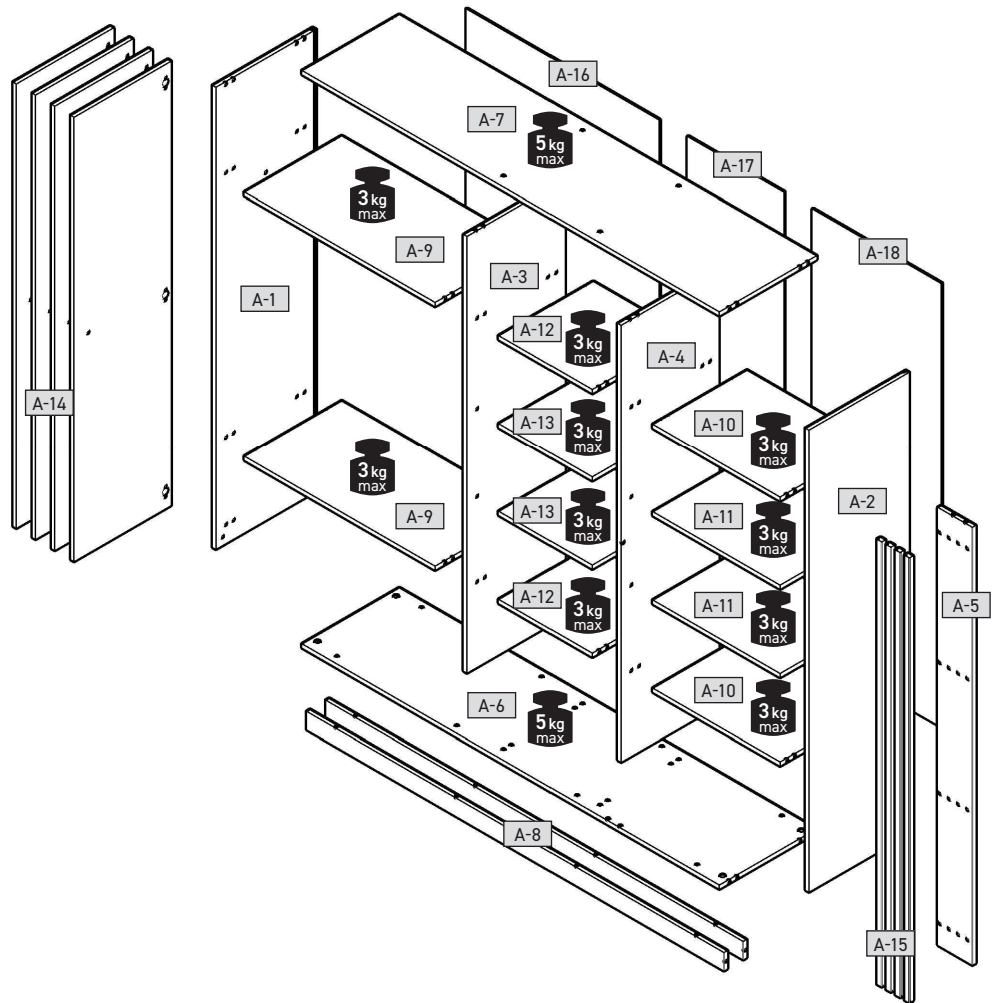
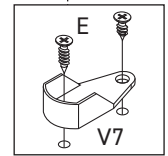
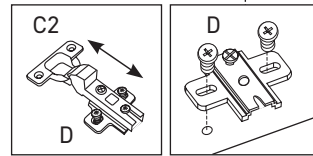
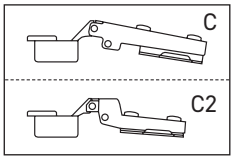
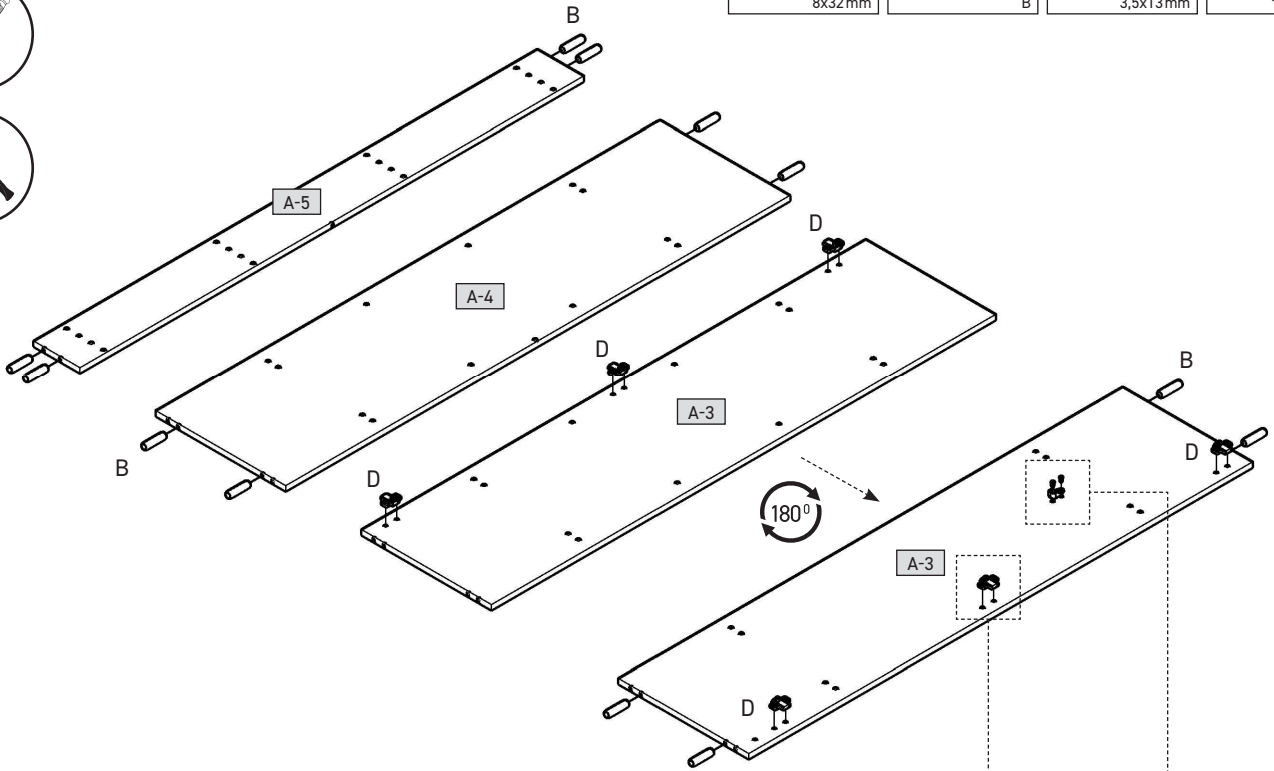
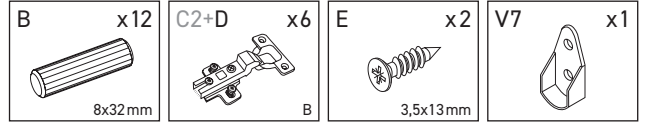

2

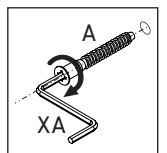
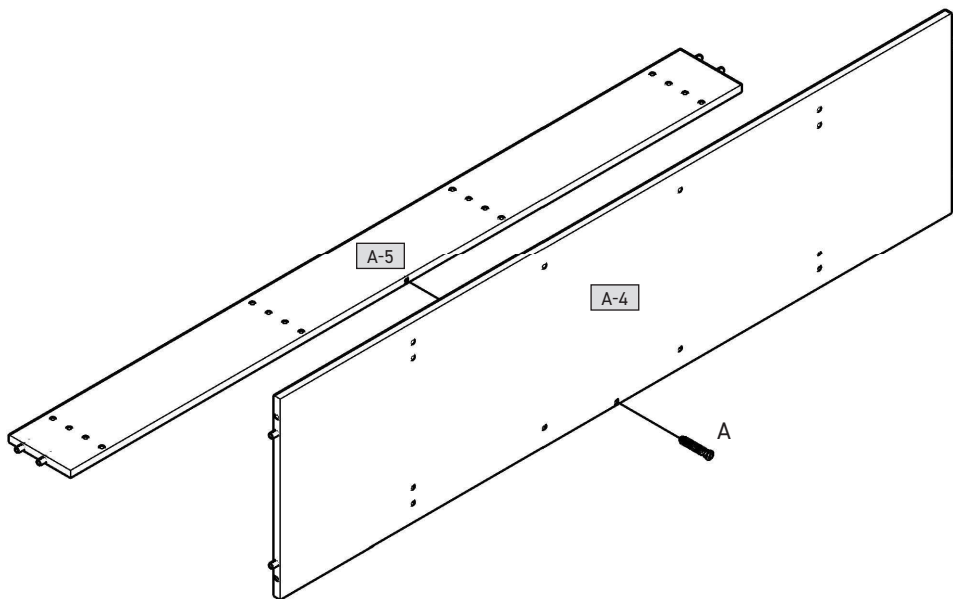
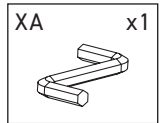
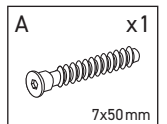

3

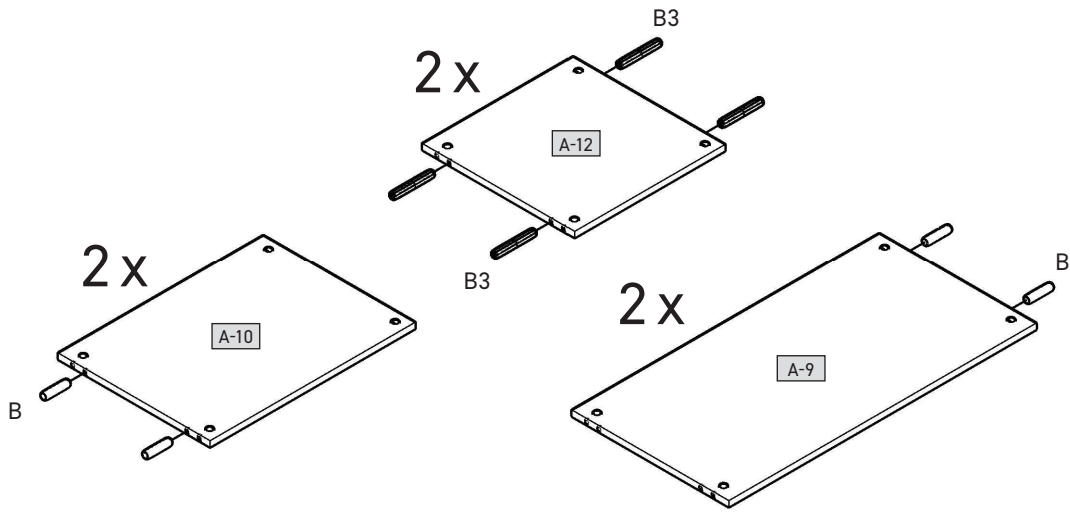
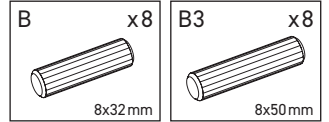

4

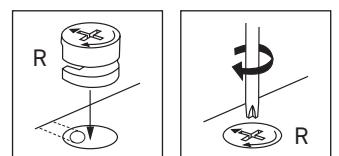
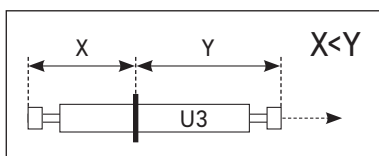
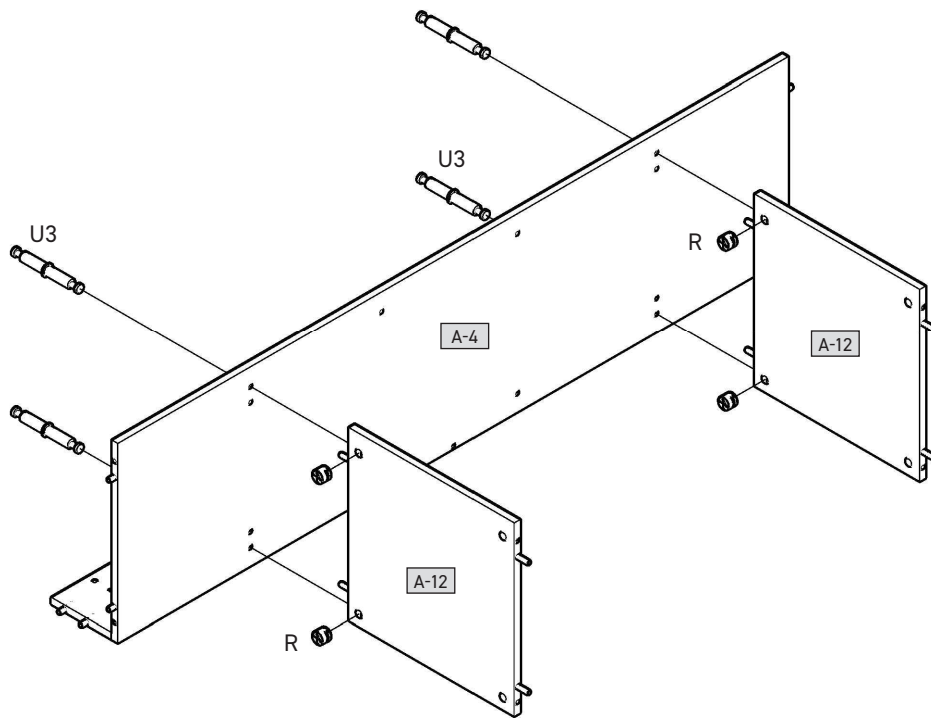
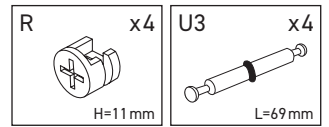

5

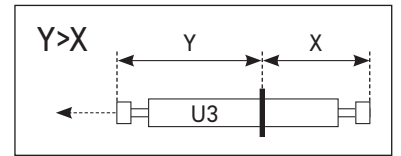
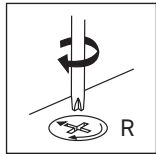
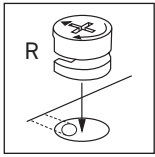
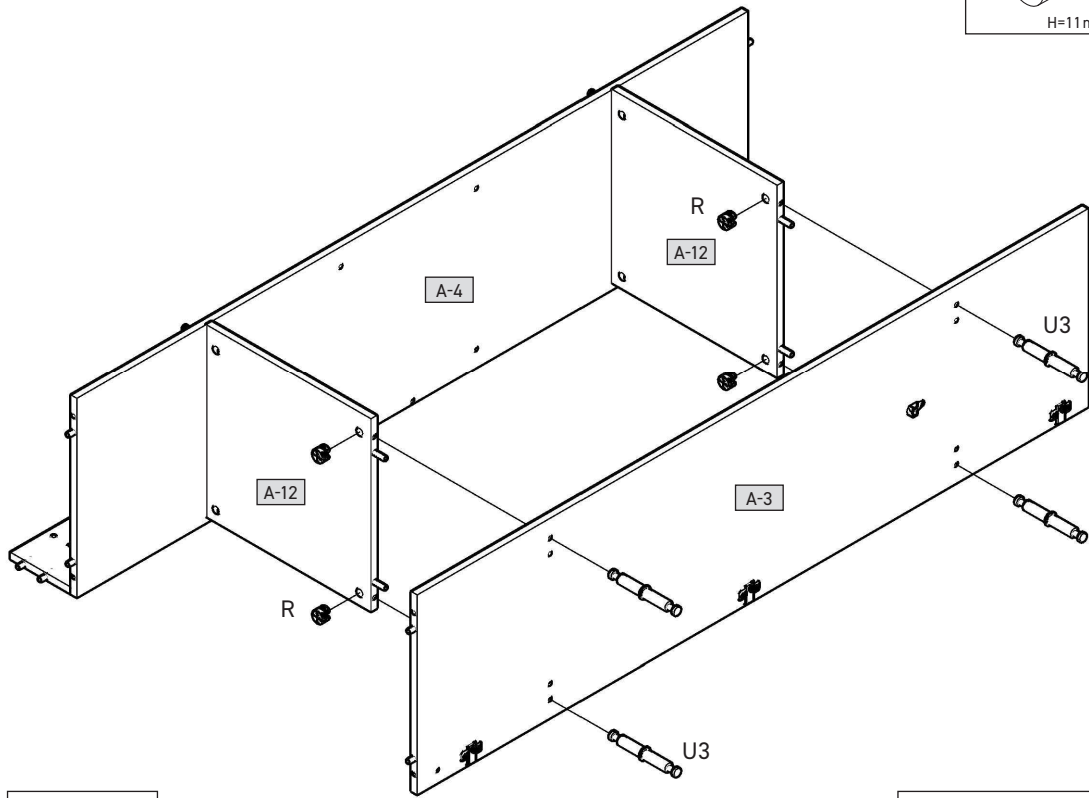
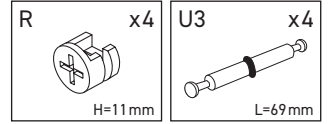

6

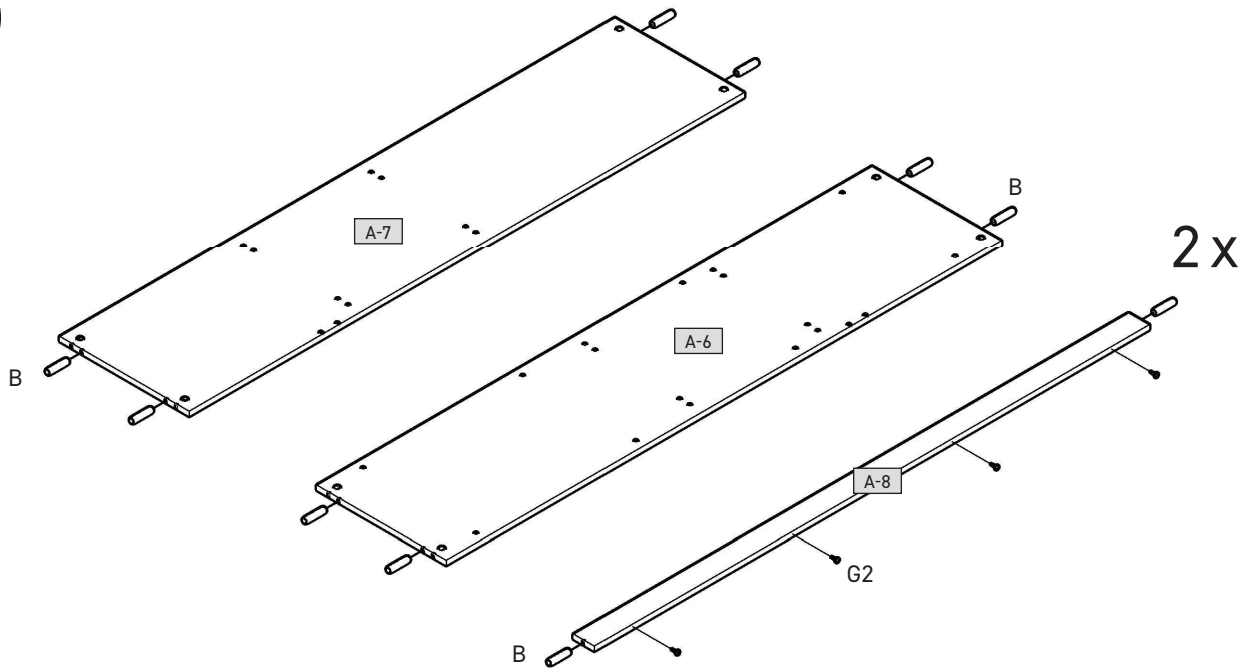
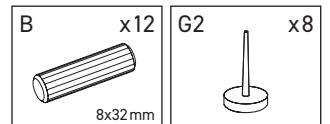

7

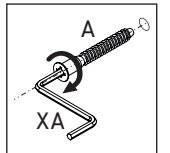
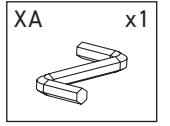
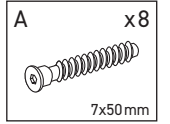
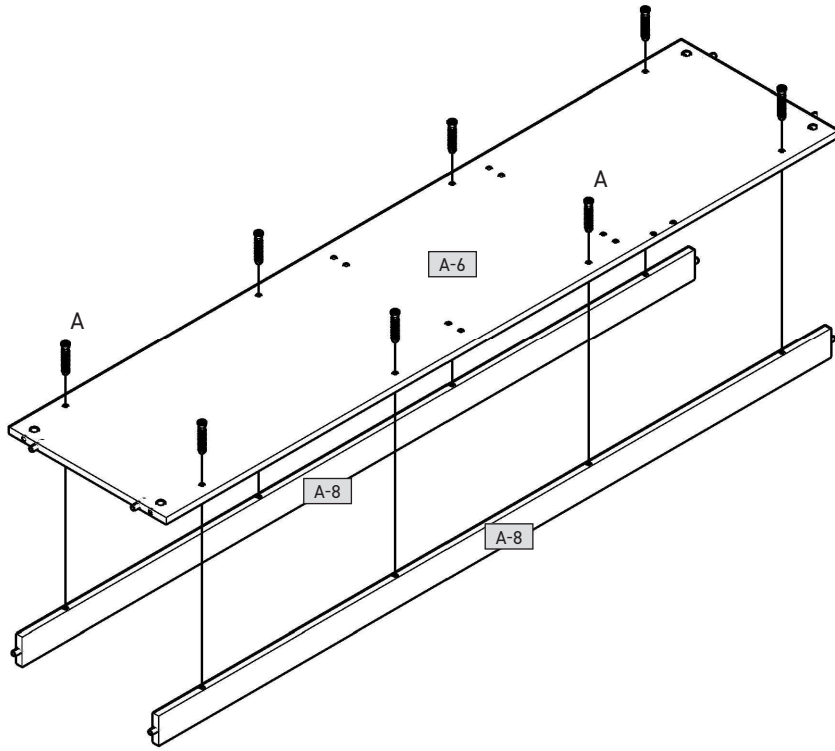

8

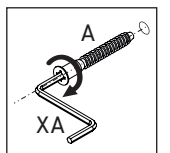
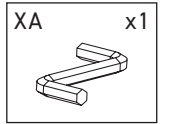
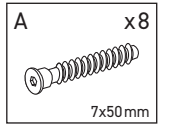
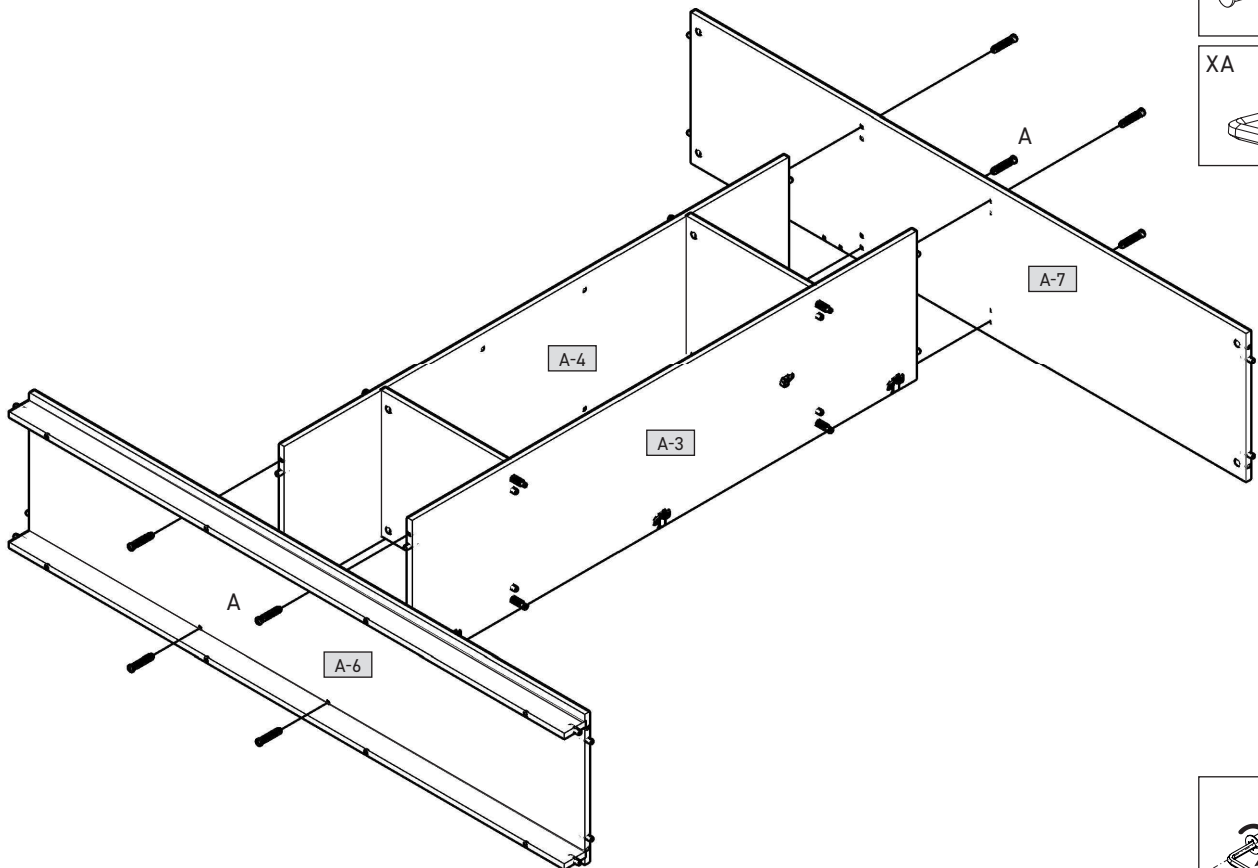

9

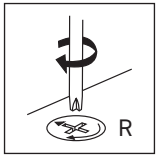
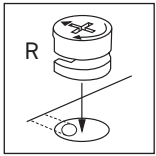
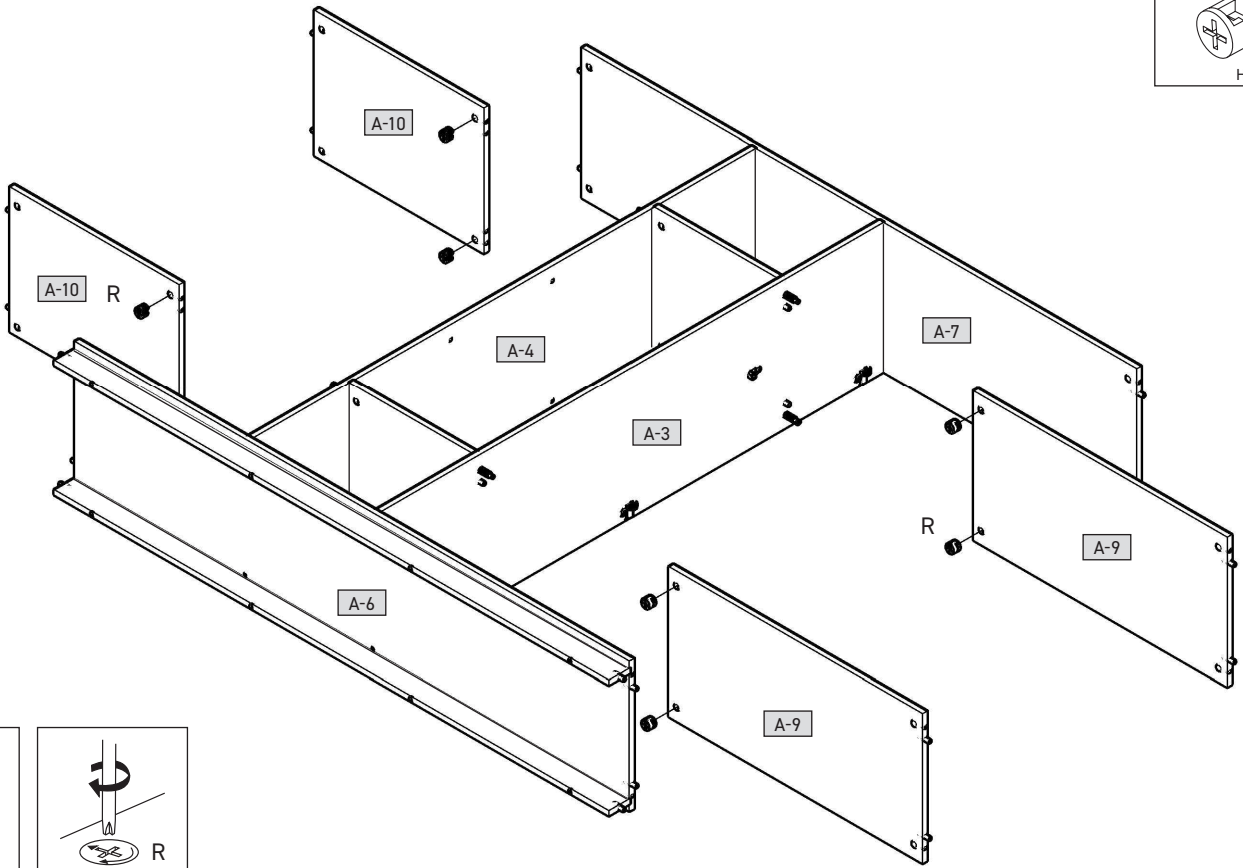
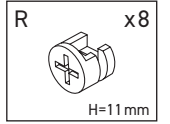

10

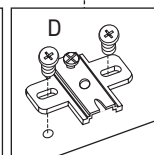
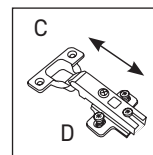
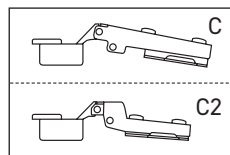
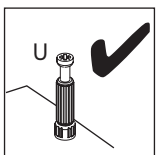
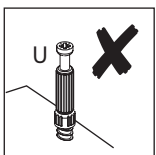
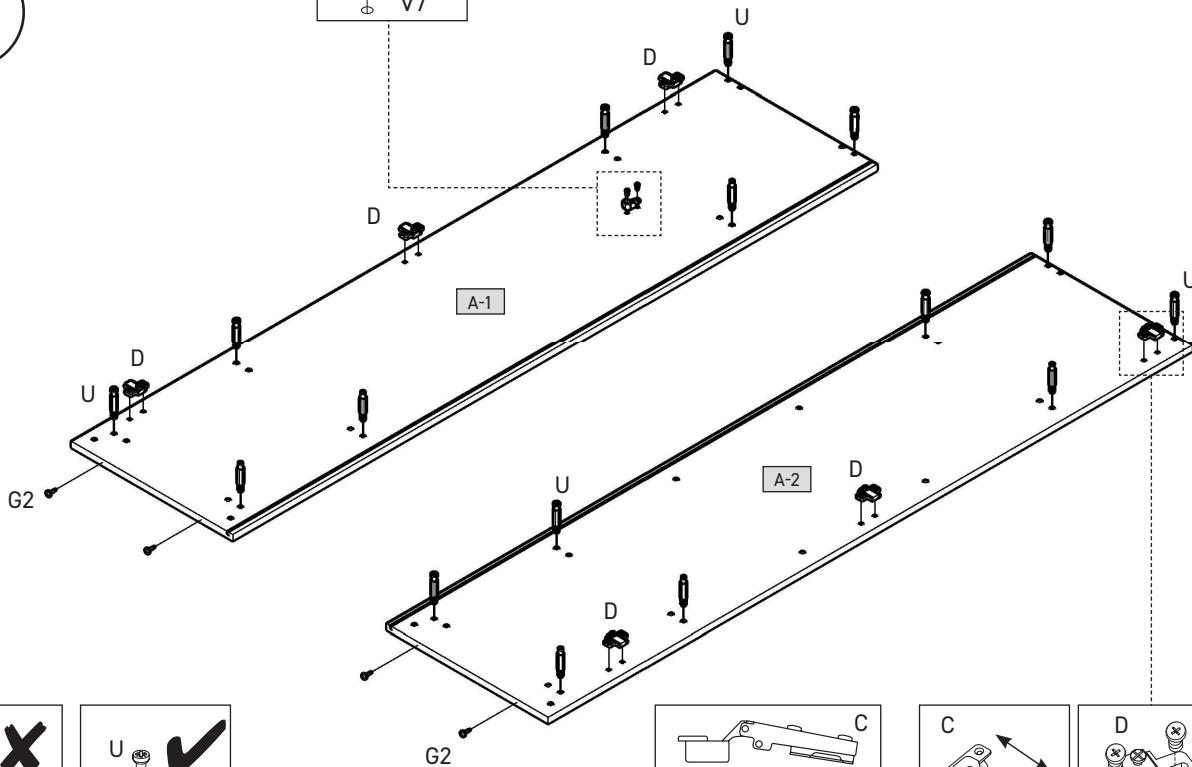
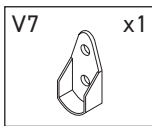
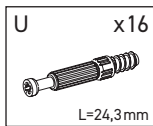
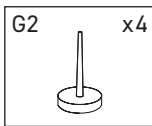
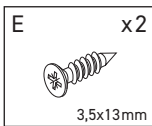
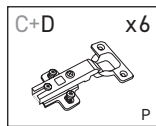
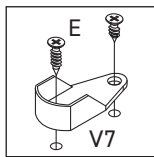

11

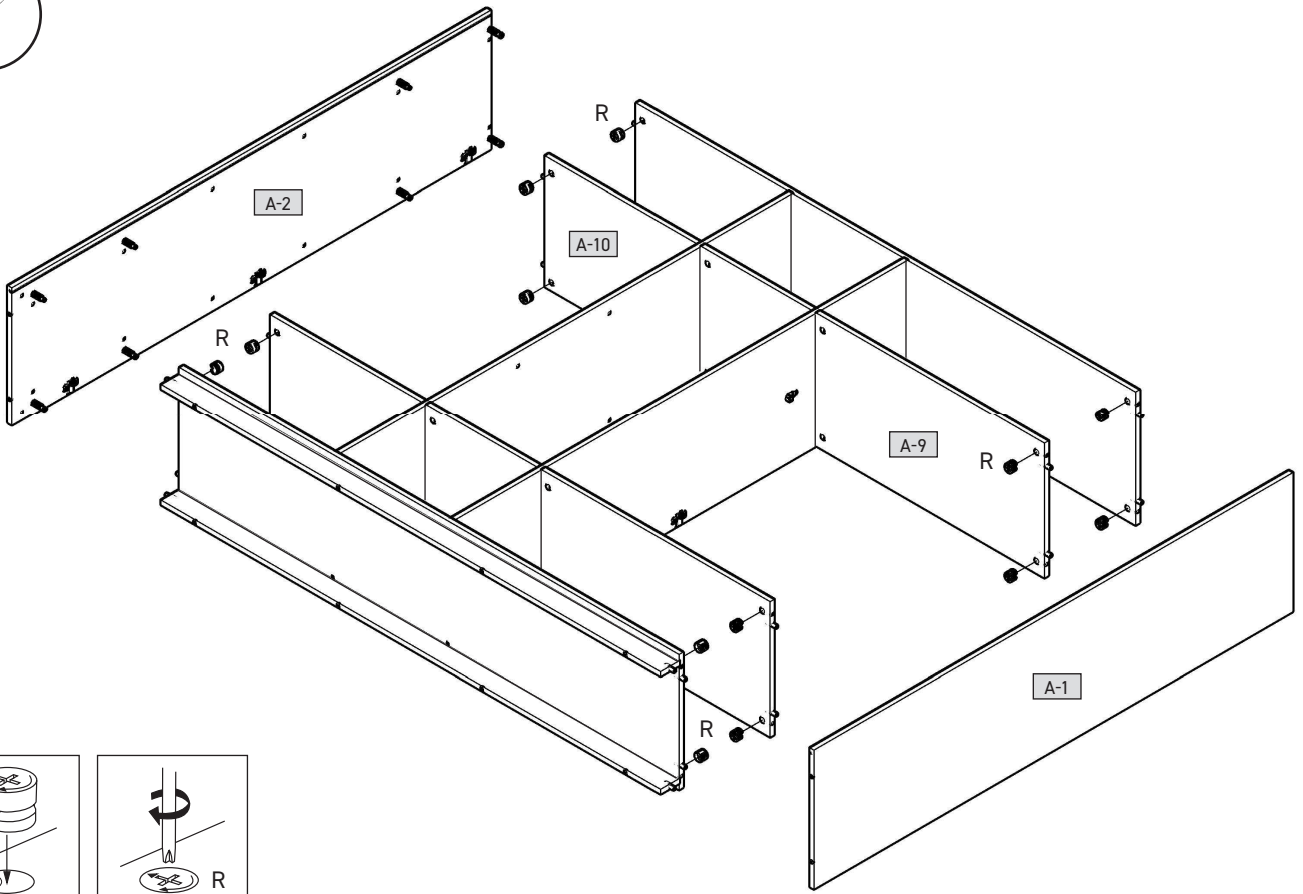
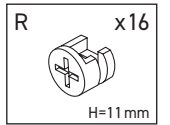

12

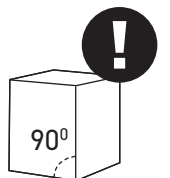
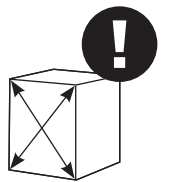
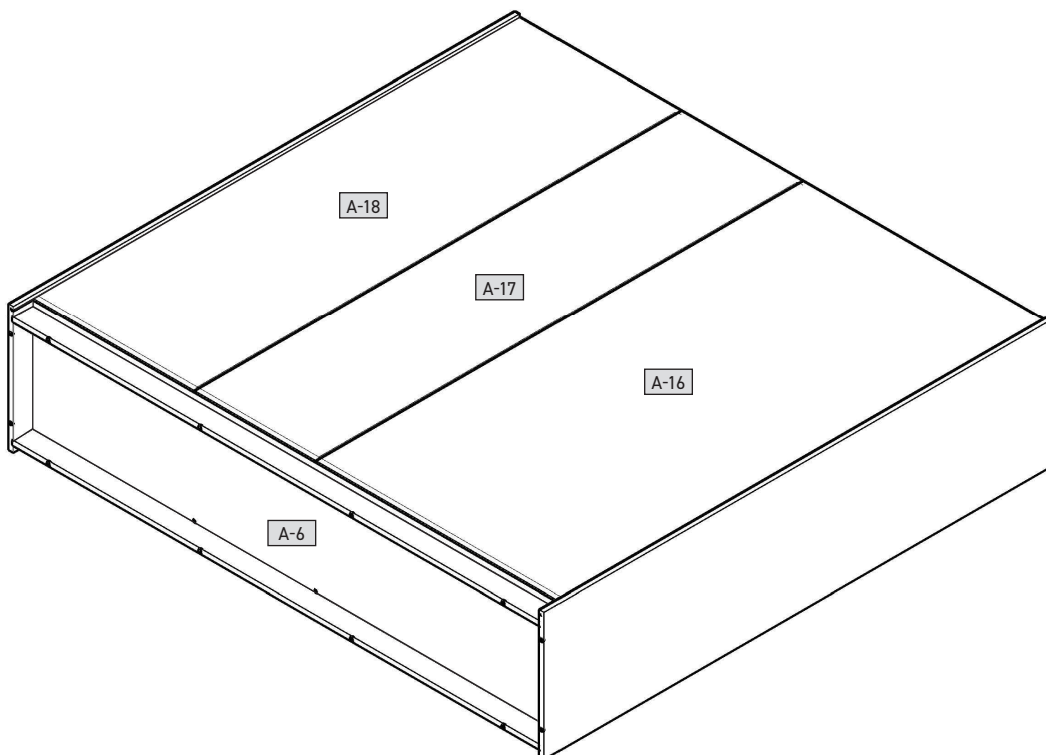

13

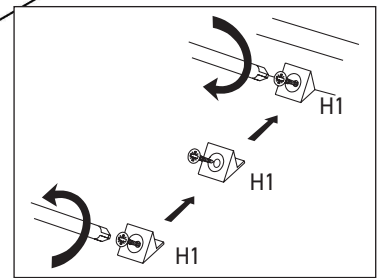
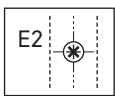
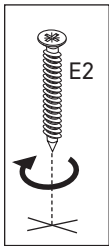
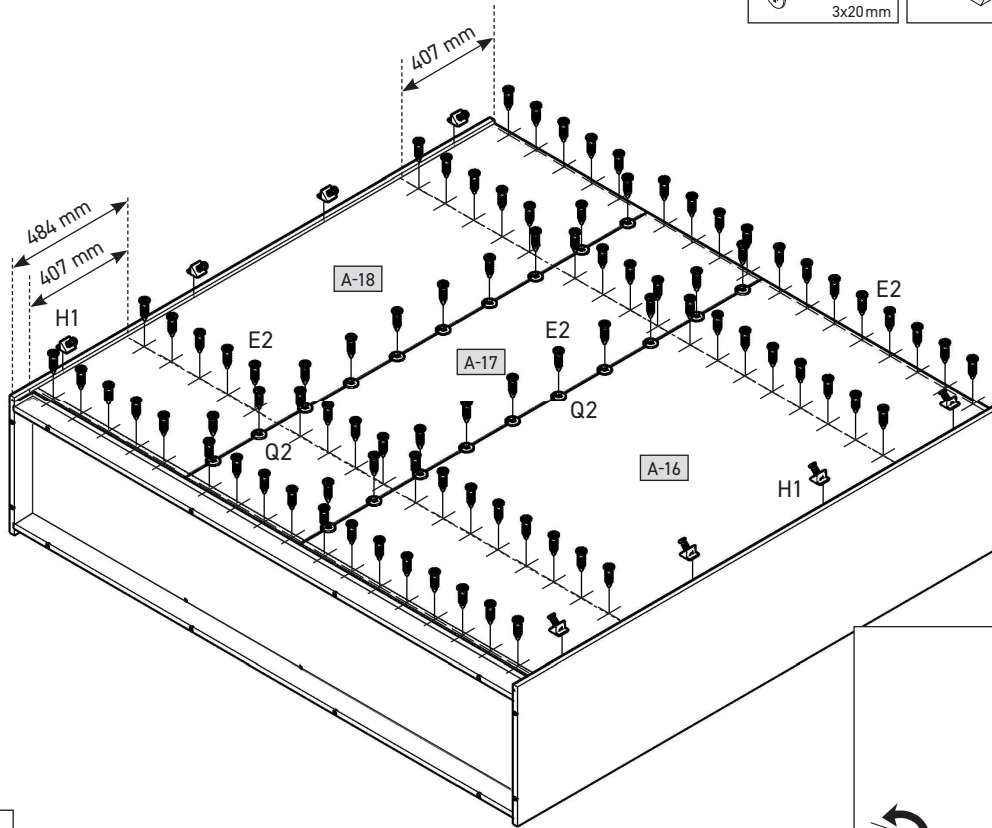
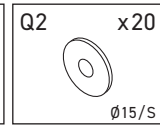
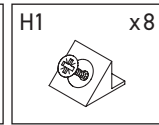
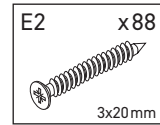

14

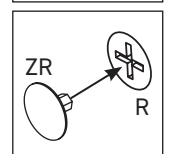
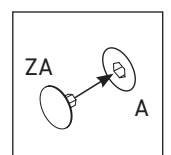
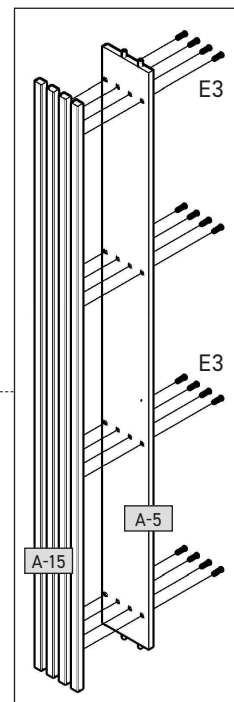
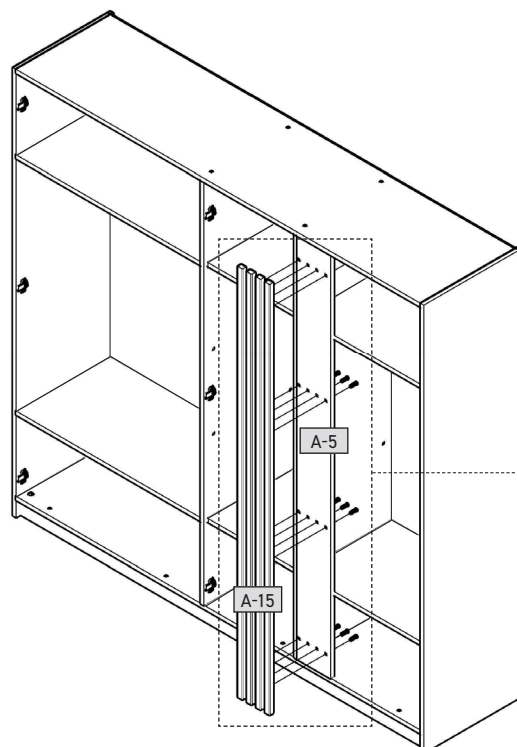
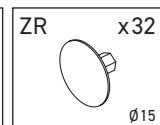
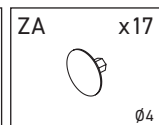
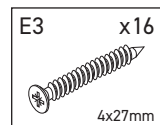

15



| | | | |
|------------------|-------|-----------------|-------|
| E x1 3,5x13mm | P x16 | V x1 L=985mm | W1 x1 |
|------------------|-------|-----------------|-------|

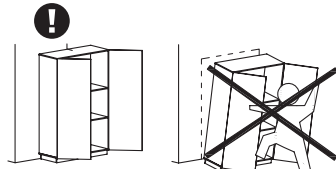
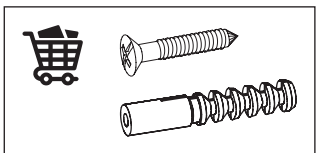
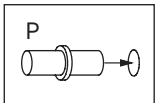
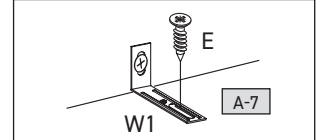
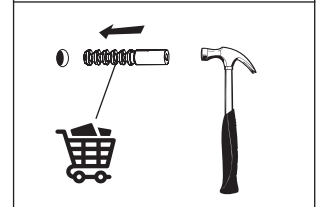
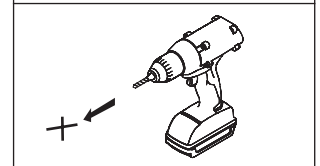
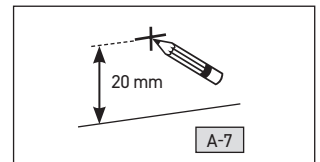
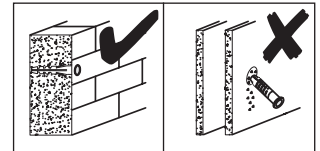
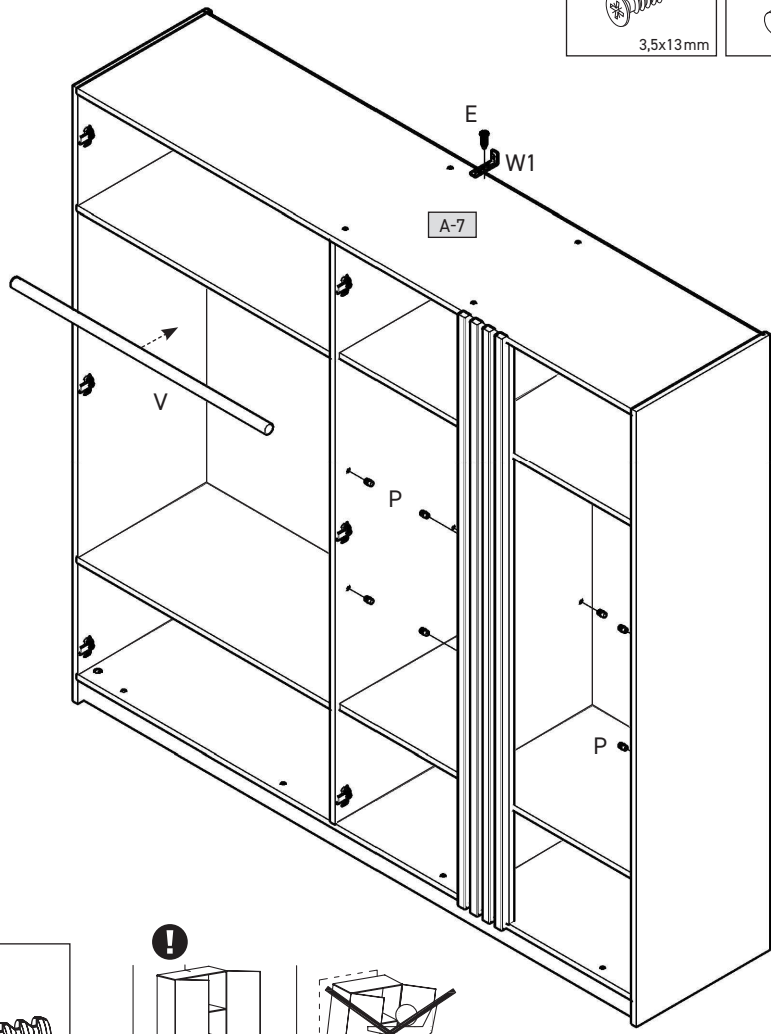

16



| | | |
|--------|---------|-------------------|
| C+D x6 | C2+D x6 | E x24 3,5x13mm |
|--------|---------|-------------------|

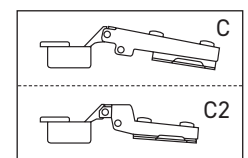
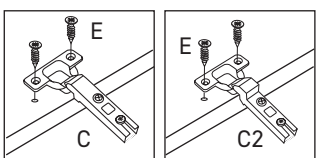
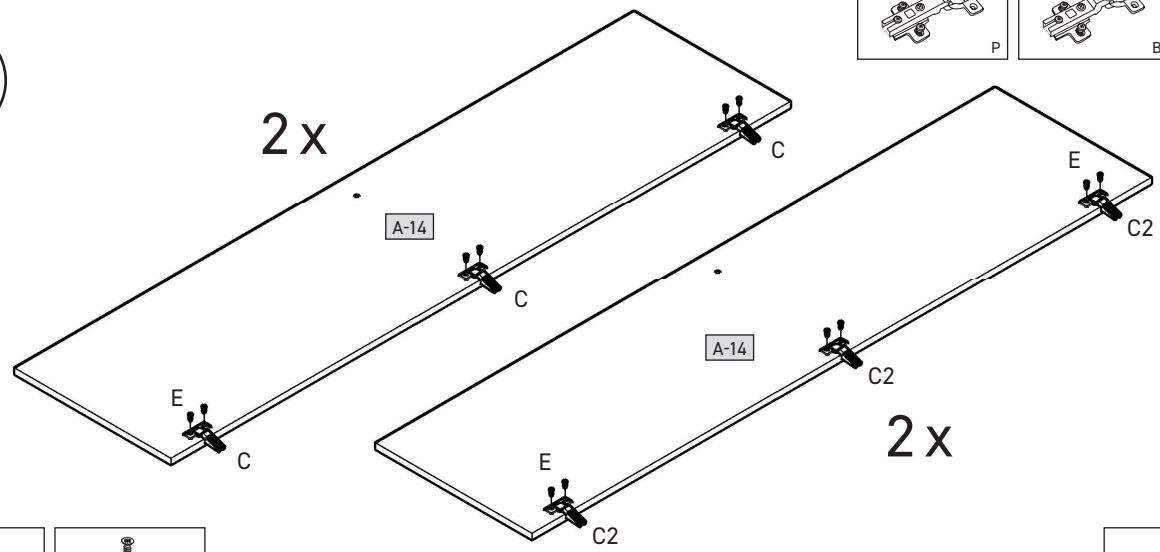

17

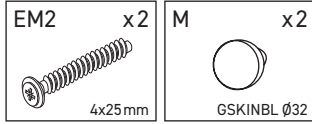

18

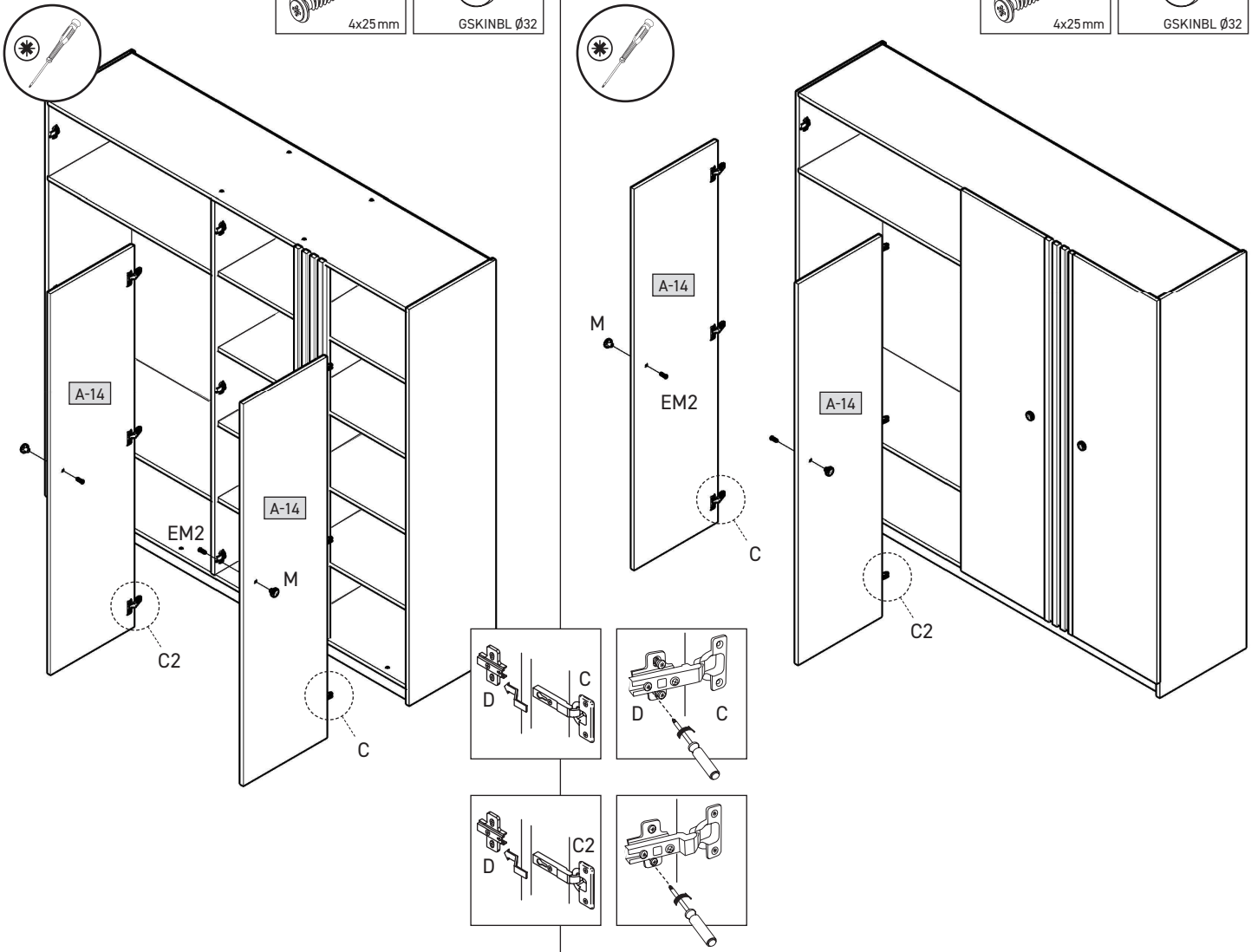
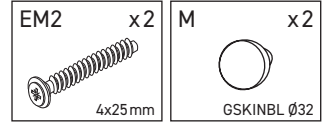

19

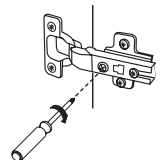
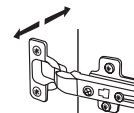
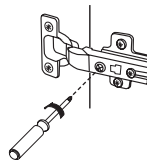
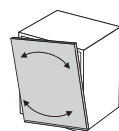
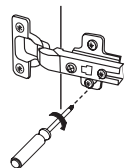
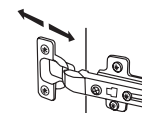
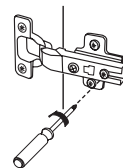
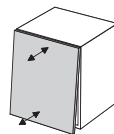
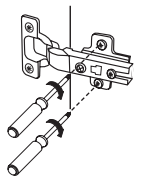
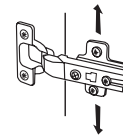
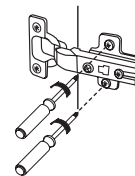
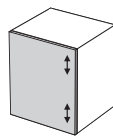
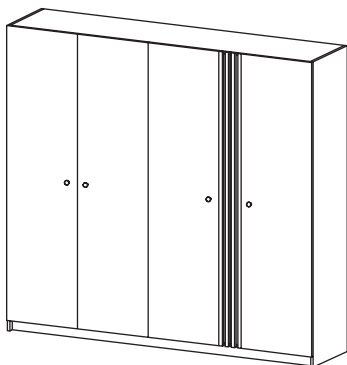

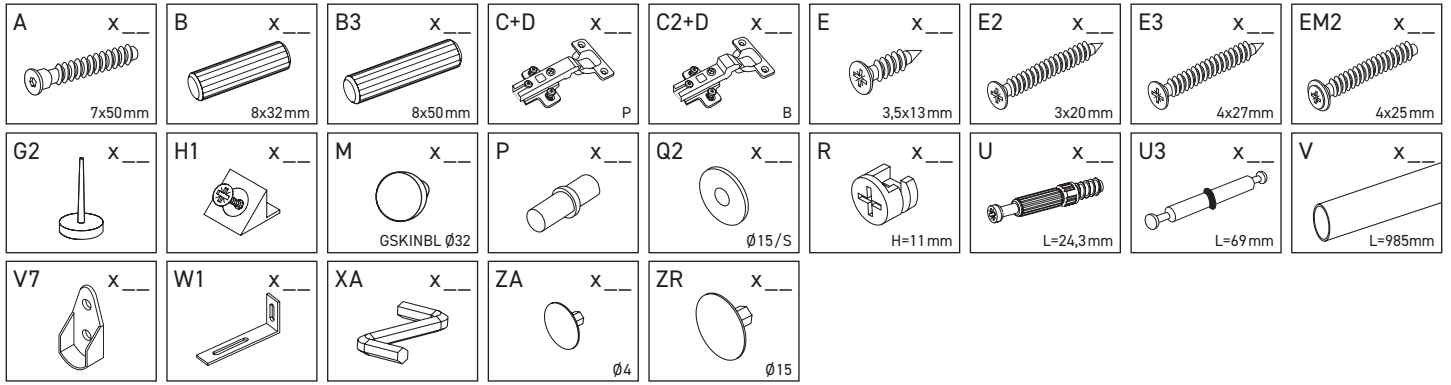

| | | | | | |
|------|------|------|----|-----|-----|
| A-1 | 2080 | 520 | 16 | x 1 | 1/4 |
| A-2 | 2080 | 520 | 16 | x 1 | 1/4 |
| A-3 | 1968 | 505 | 16 | x 1 | 3/4 |
| A-4 | 1968 | 505 | 16 | x 1 | 3/4 |
| A-5 | 1968 | 178 | 16 | x 1 | 2/4 |
| A-6 | 2168 | 505 | 16 | x 1 | 2/4 |
| A-7 | 2168 | 505 | 16 | x 1 | 2/4 |
| A-8 | 2168 | 80 | 16 | x 2 | 2/4 |
| A-9 | 991 | 505 | 16 | x 2 | 1/4 |
| A-10 | 661 | 489 | 16 | x 2 | 3/4 |
| A-11 | 661 | 489 | 16 | x 2 | 1/4 |
| A-12 | 484 | 489 | 16 | x 2 | 3/4 |
| A-13 | 484 | 489 | 16 | x 2 | 3/4 |
| A-14 | 504 | 2000 | 16 | x 4 | 4/4 |
| A-15 | 2000 | 24 | 18 | x 4 | 2/4 |
| A-16 | 1006 | 1998 | 3 | x 1 | 1/4 |
| A-17 | 500 | 1998 | 3 | x 1 | 2/4 |
| A-18 | 676 | 1998 | 3 | x 1 | 2/4 |

