

60min

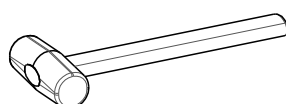

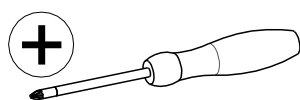

NR	ilość	szer. [mm]	dł. [mm]
1	1	1500	400
2	1	1500	400
3	1	568	384
4	1	568	359
5	1	568	359
6	1	568	384
7	1	560	492
8	1	560	492
9	3	184	500
10	3	350	130
11	3	350	130
12	3	417	103
13	3	425	353
14	1	1494	297

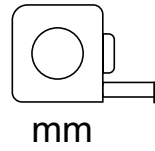
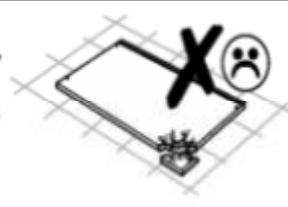
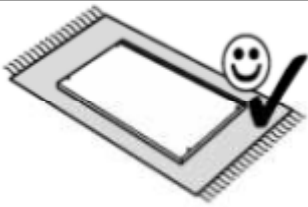
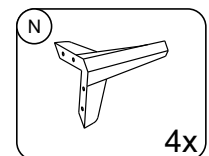
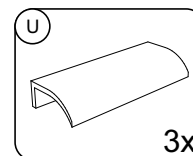
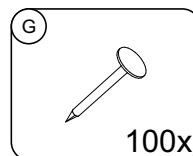
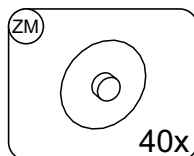
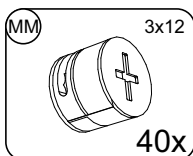
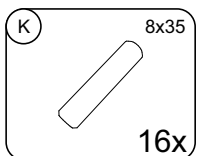
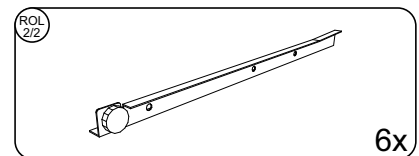
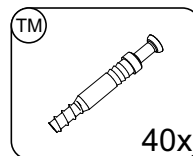
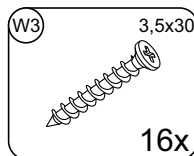
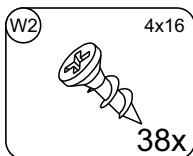
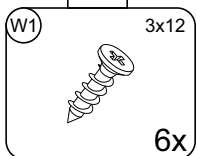
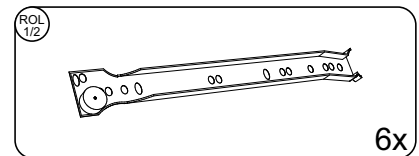
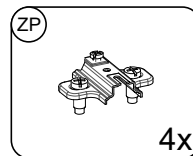
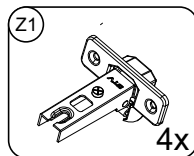
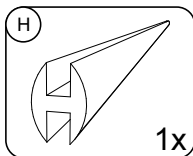
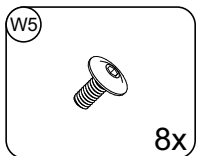
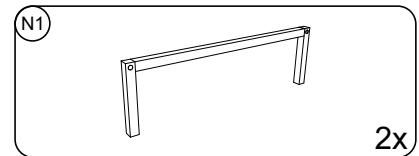
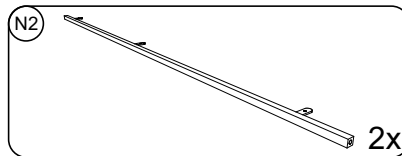
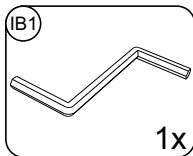
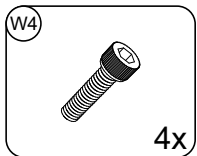
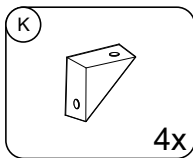
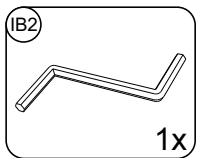
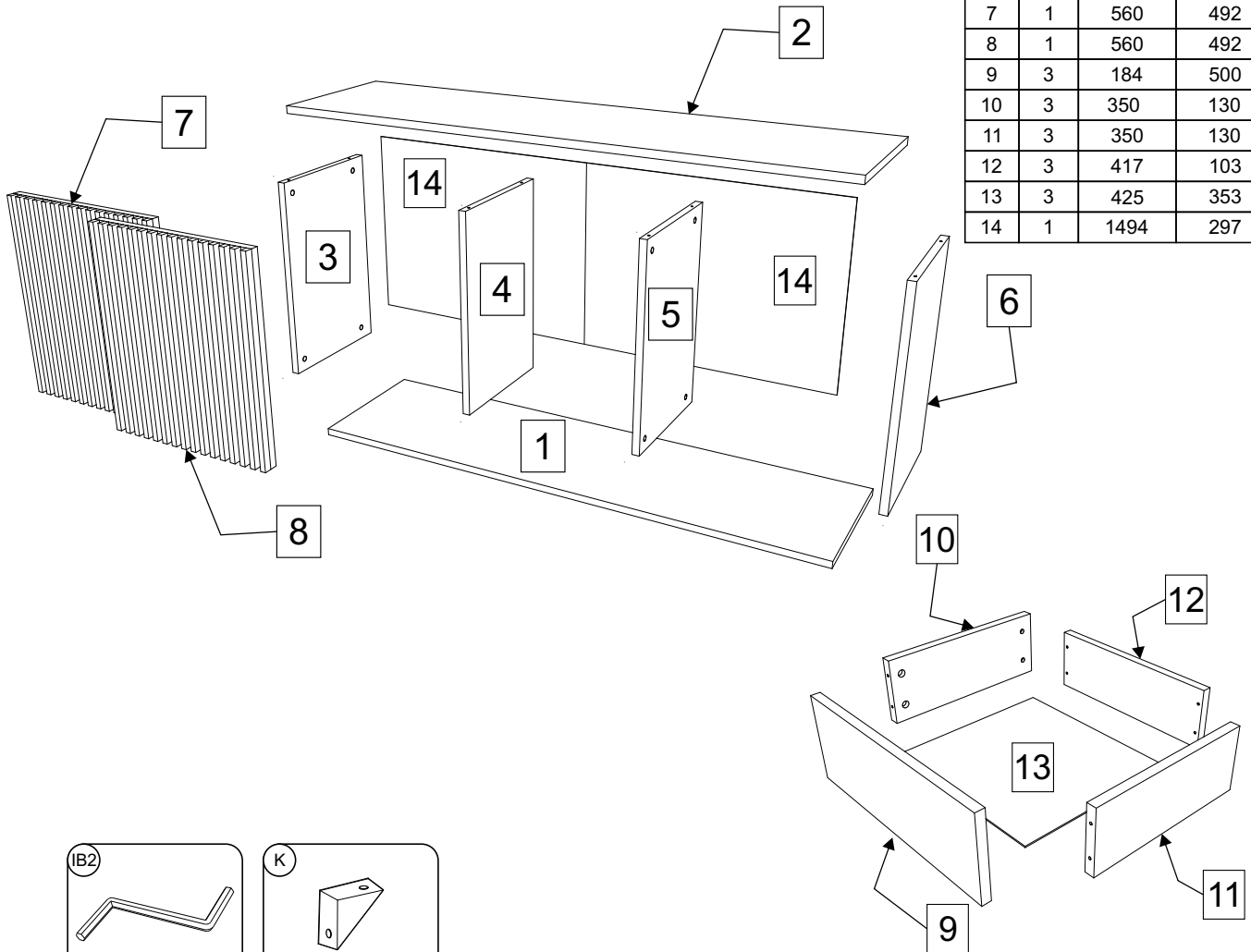

1

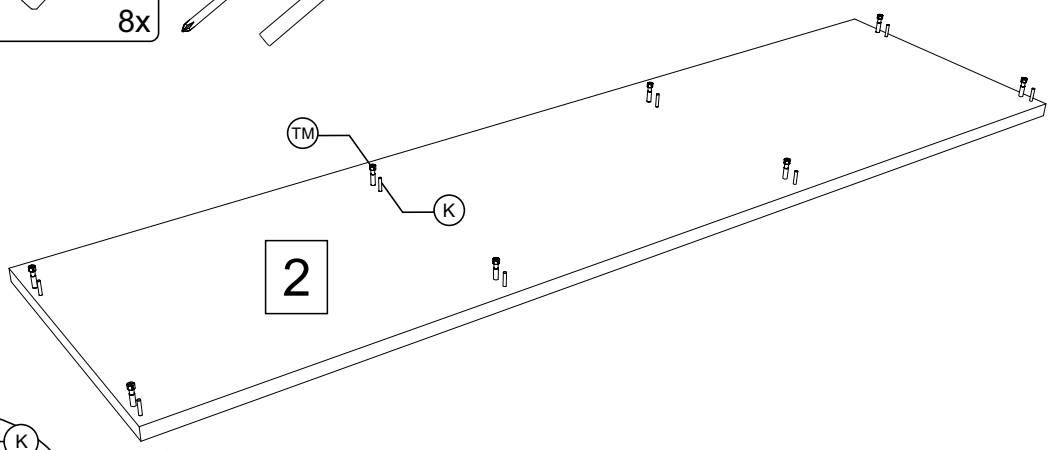
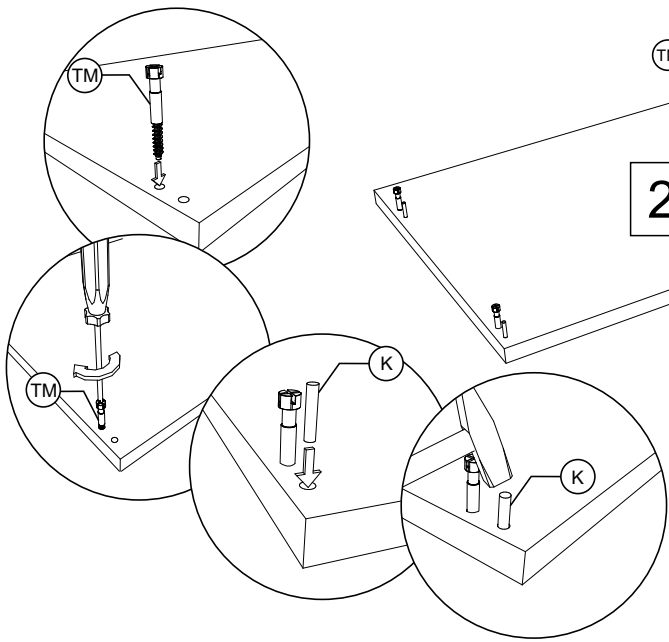
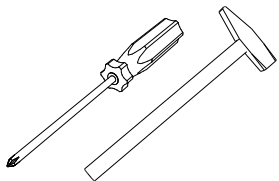
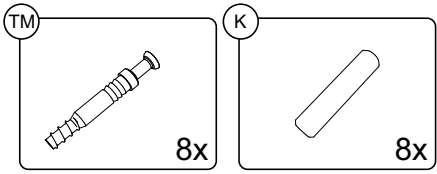

2

2

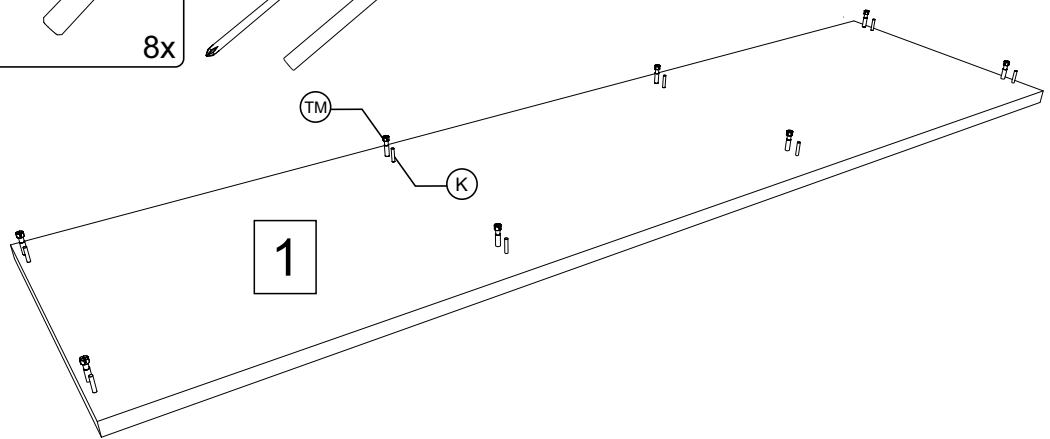
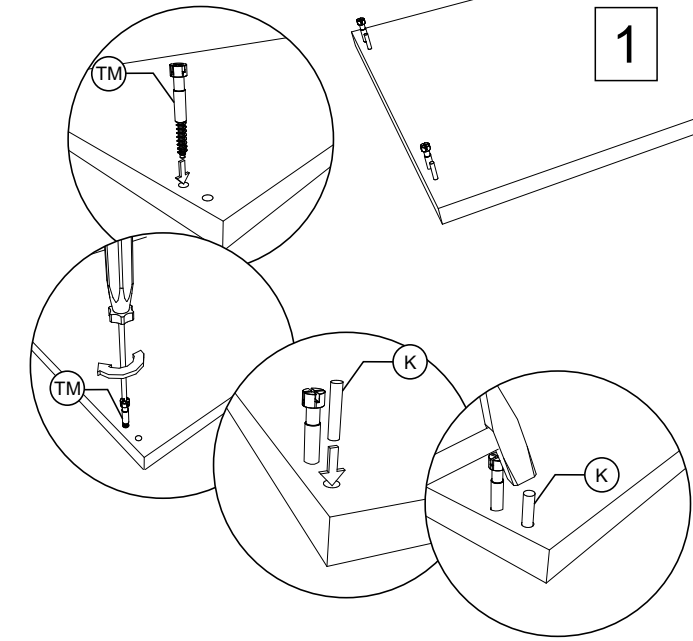
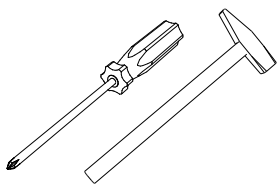
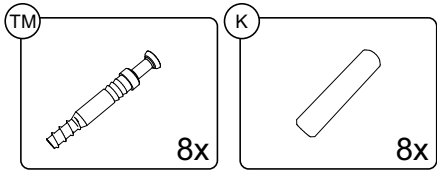

1

3

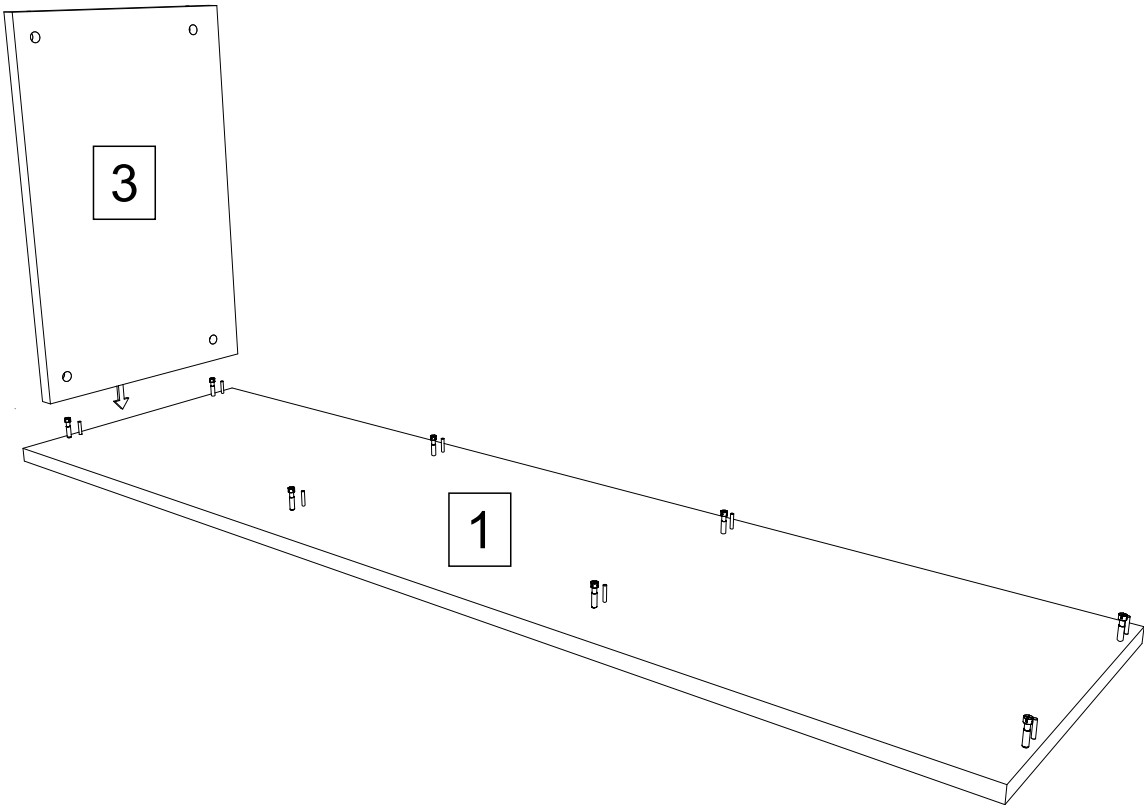

4

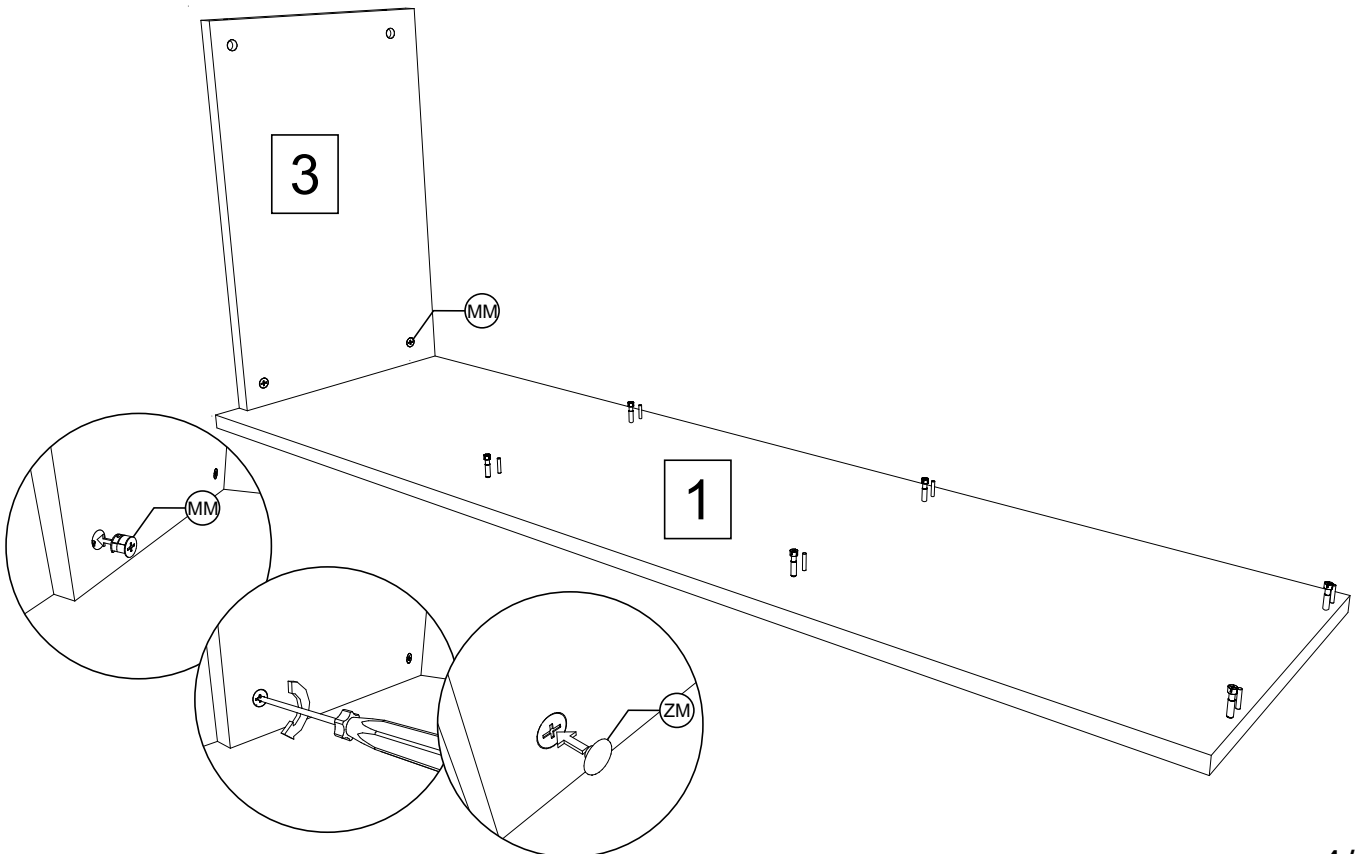
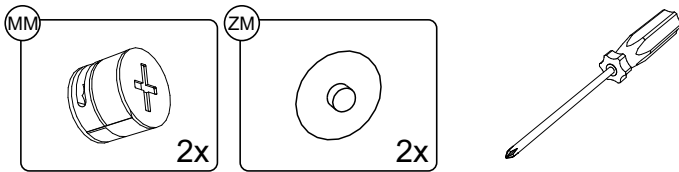

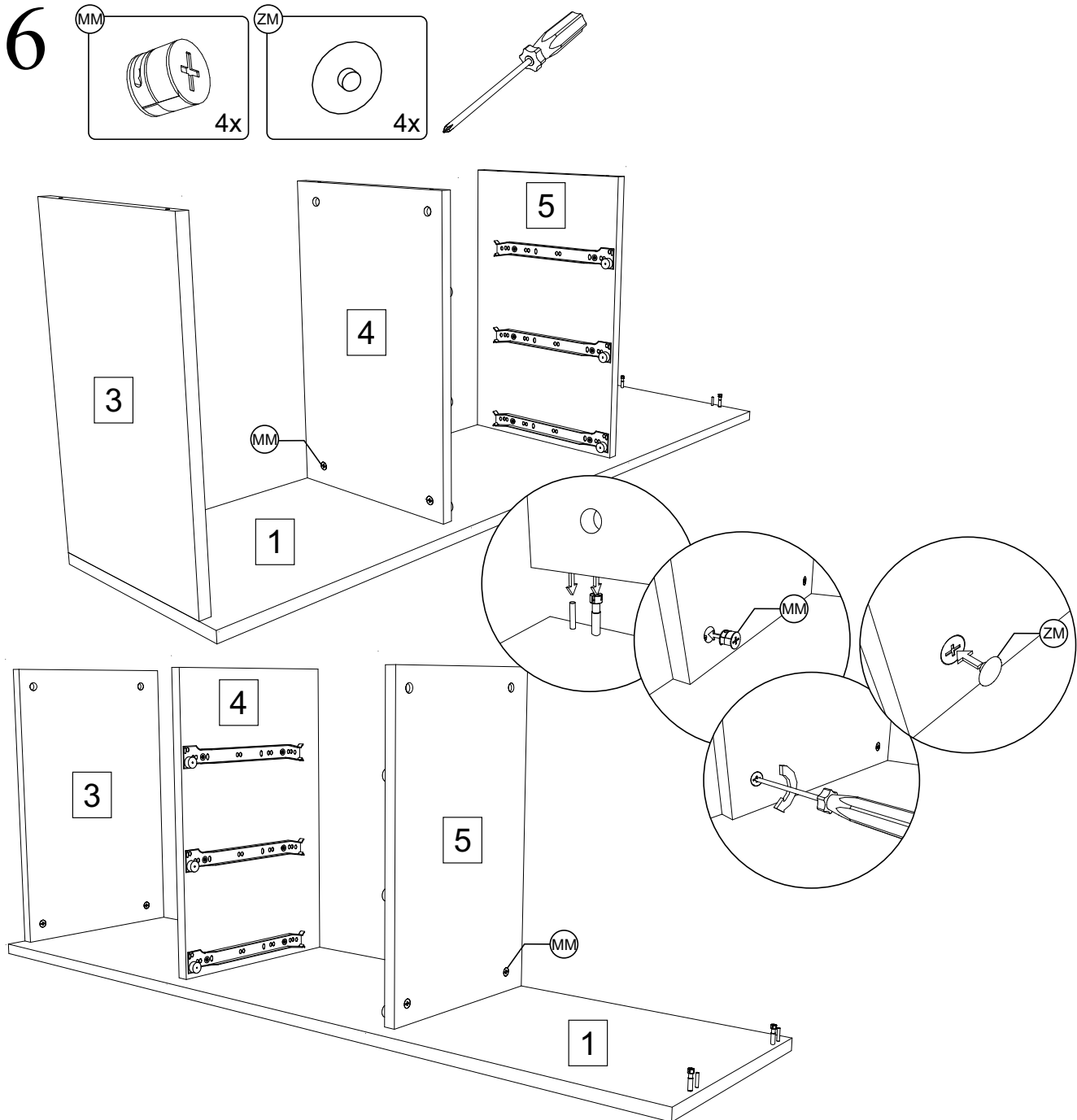
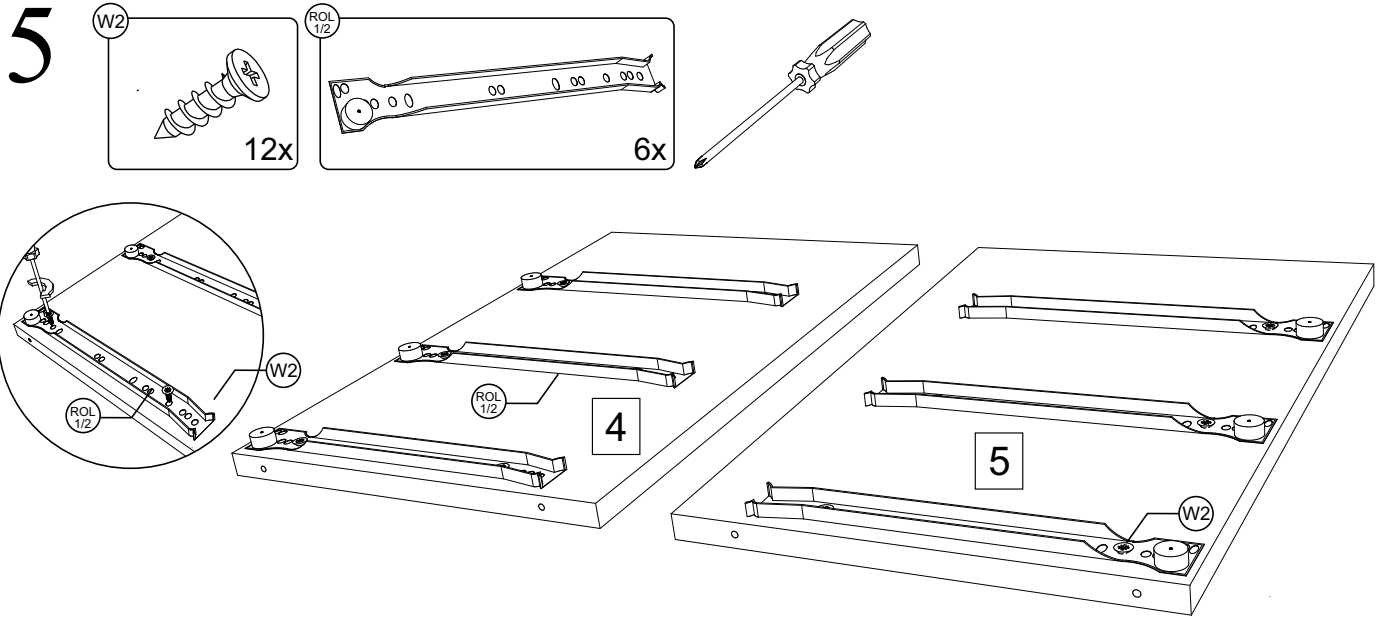

7

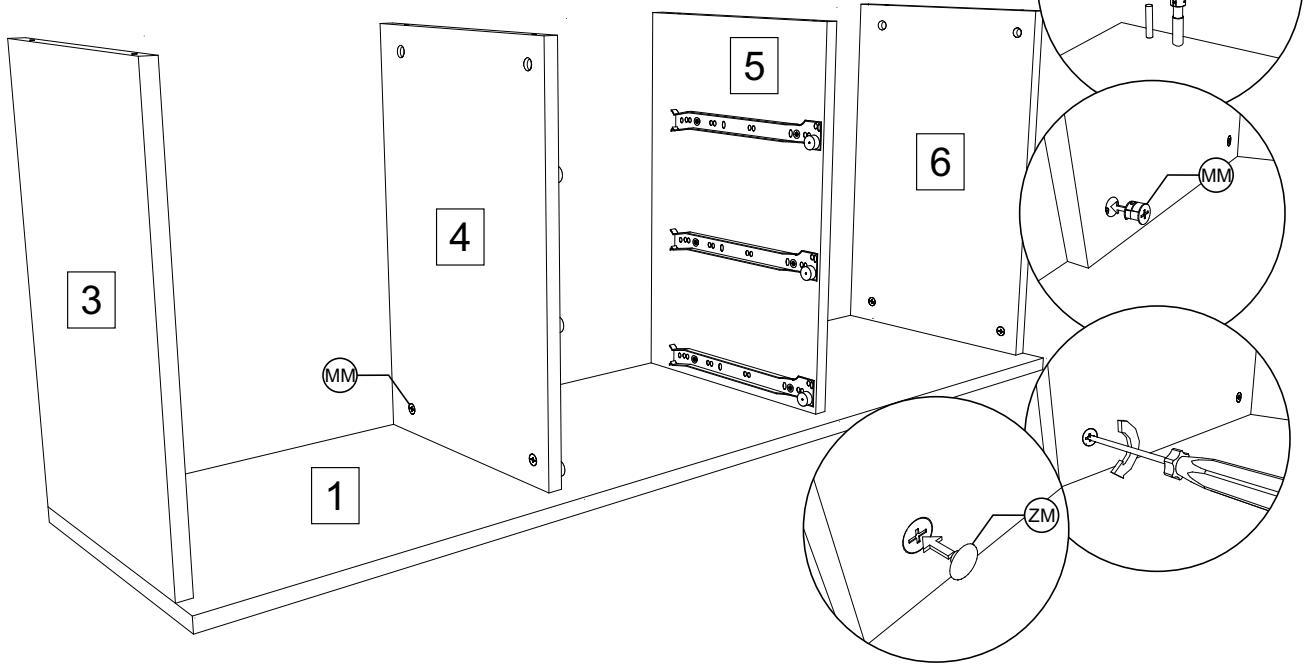
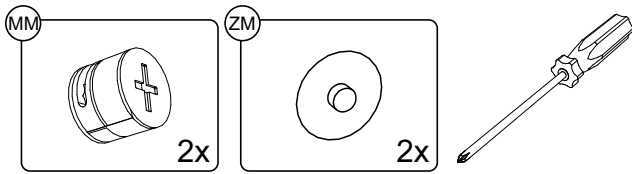

8

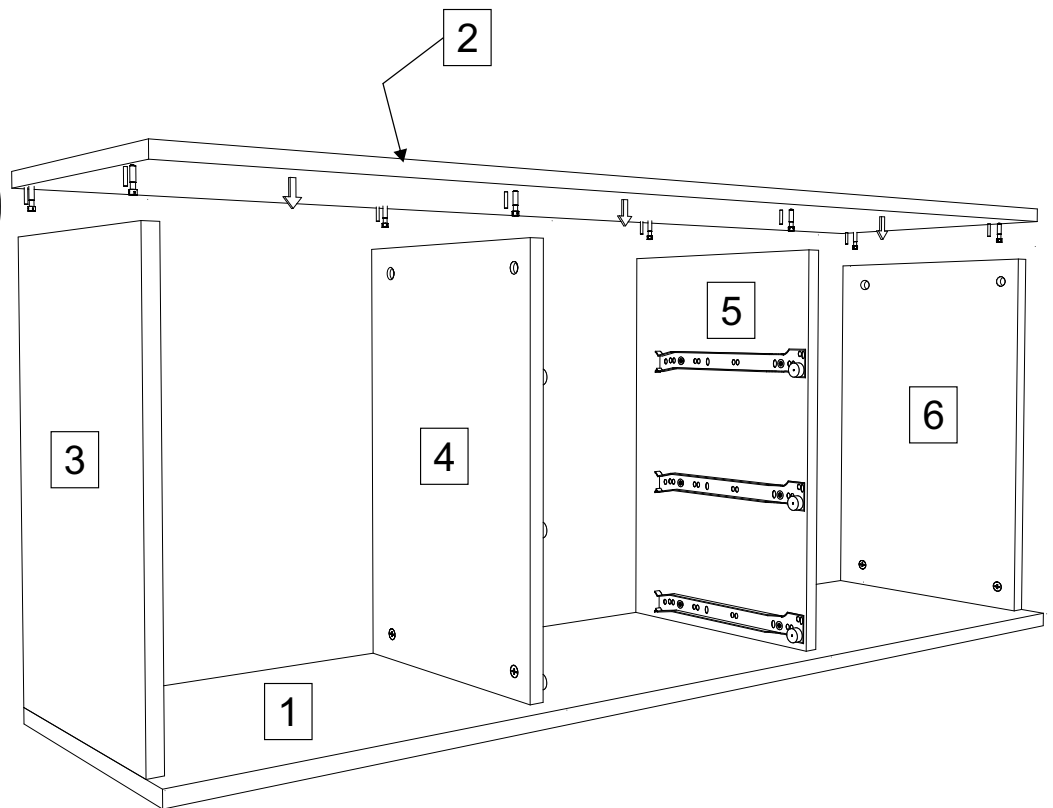
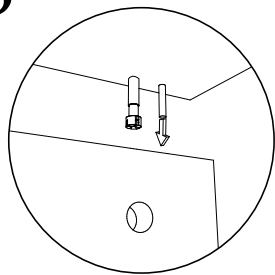

9

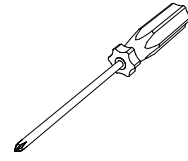
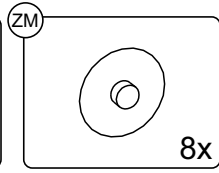
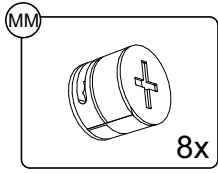

2

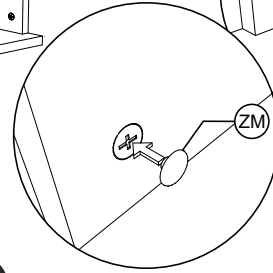
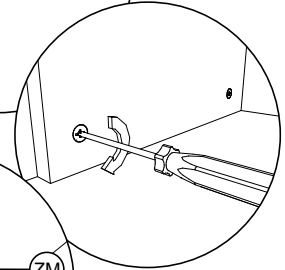
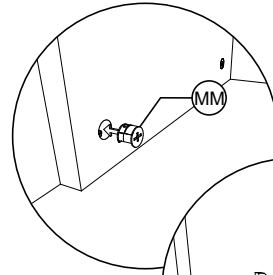
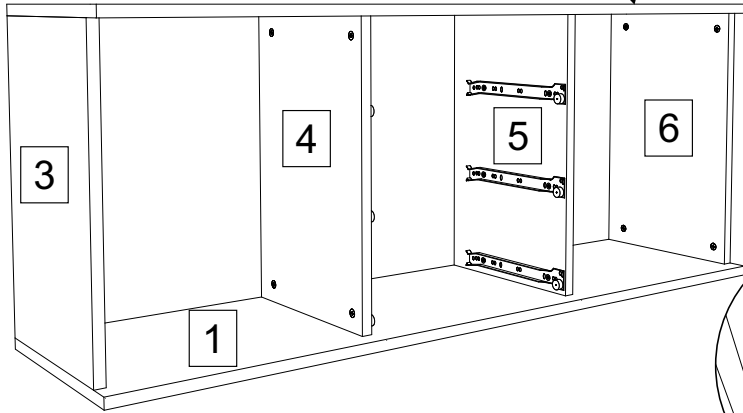

10

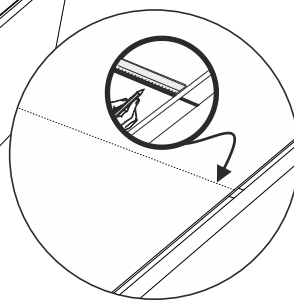
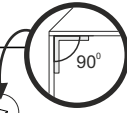
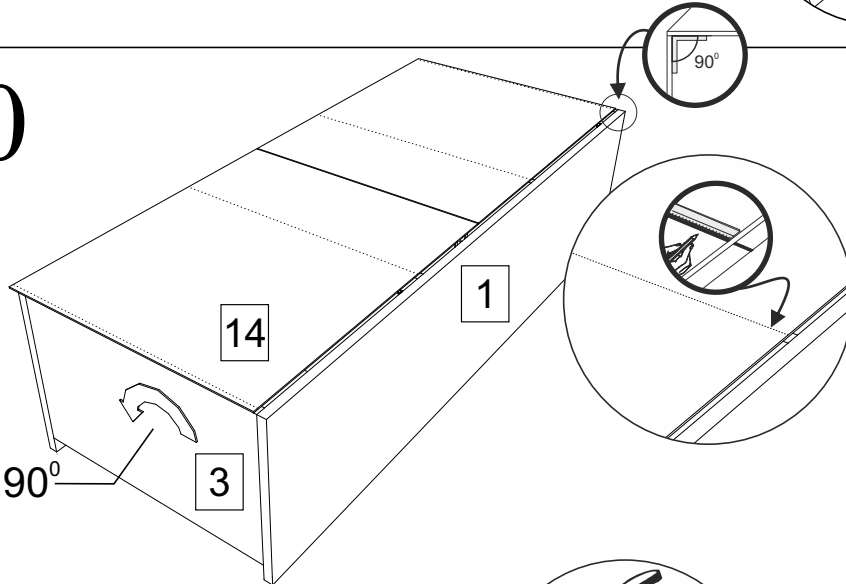

11

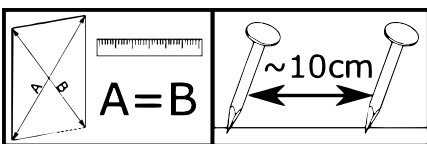
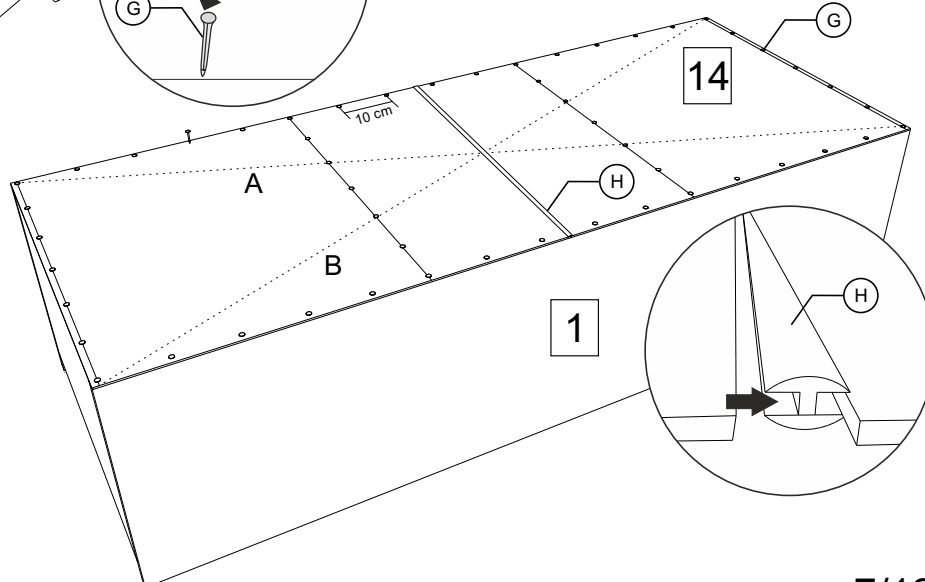
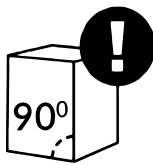
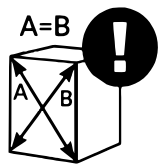
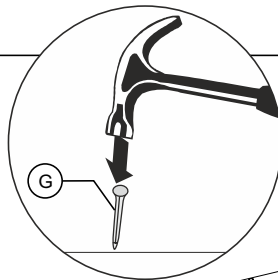
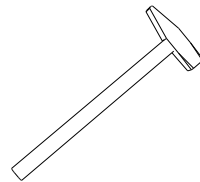
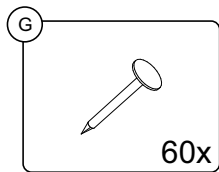

12

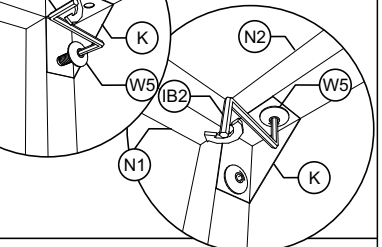
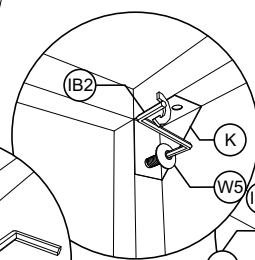
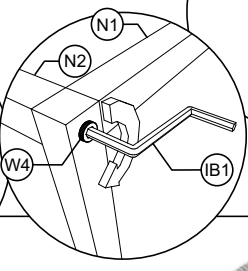
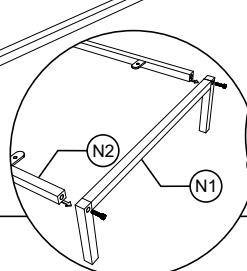
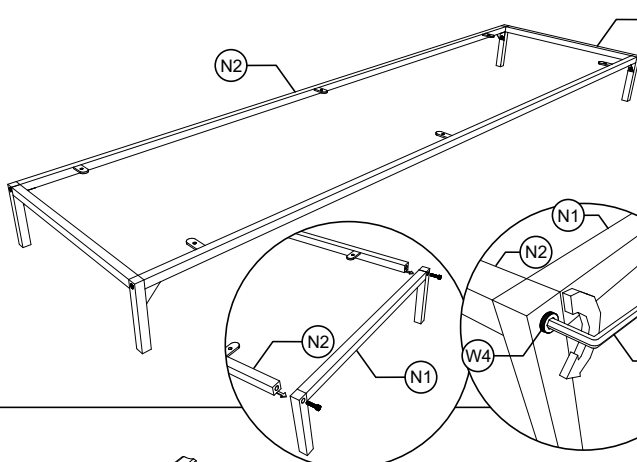
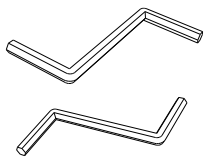
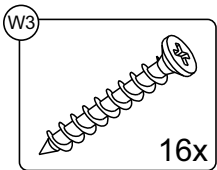
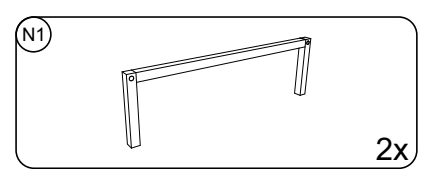
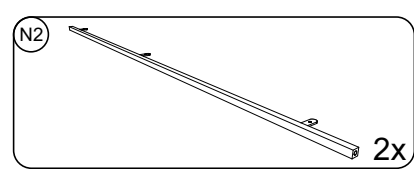
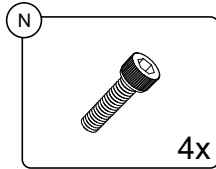
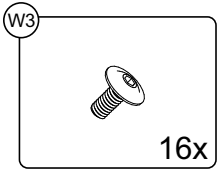

13

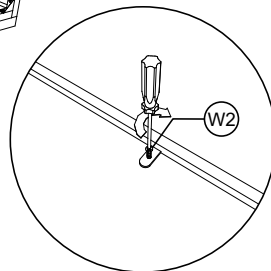
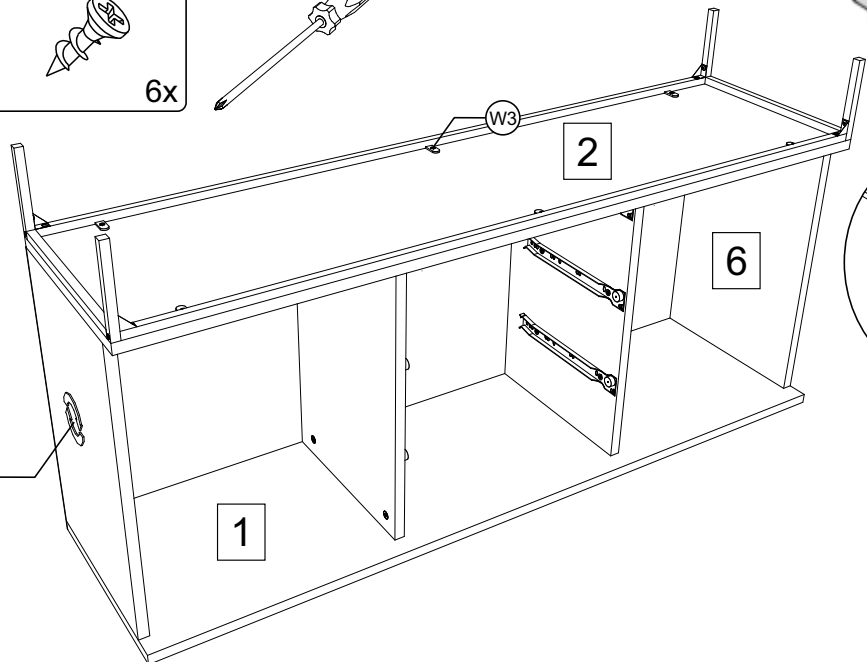
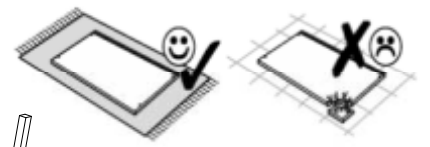
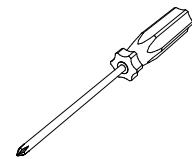
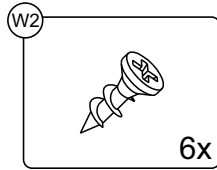

14

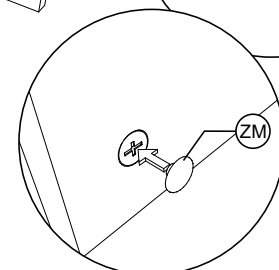
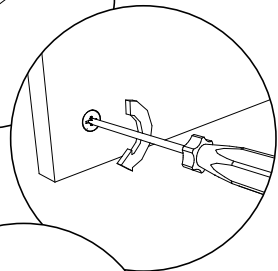
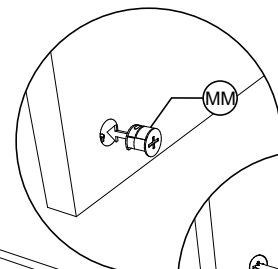
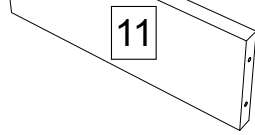
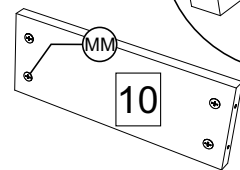
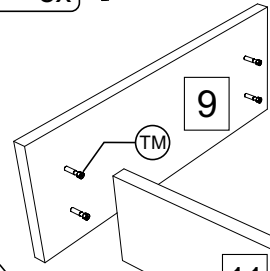
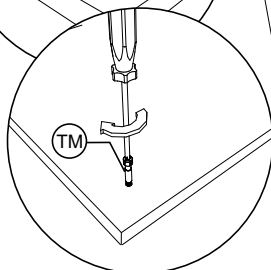
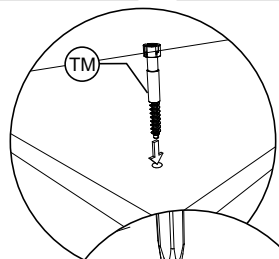
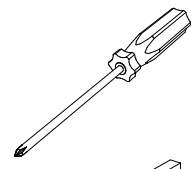
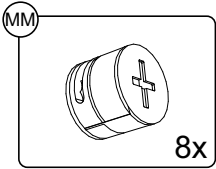
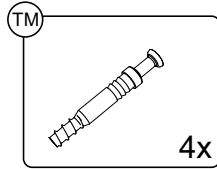

15

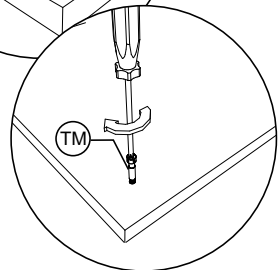
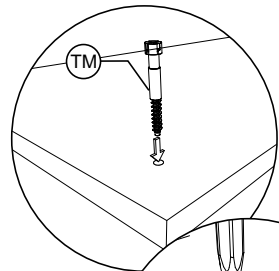
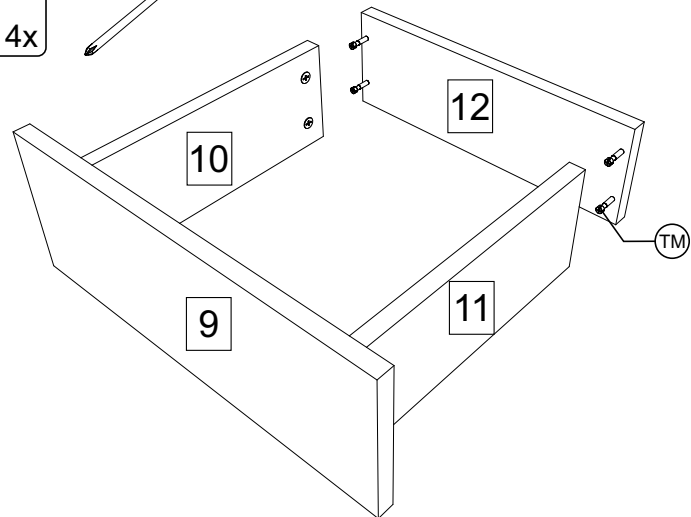
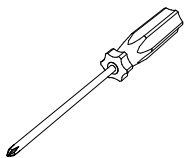
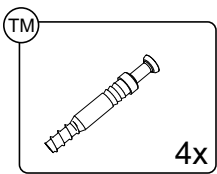

16

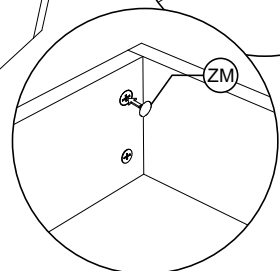
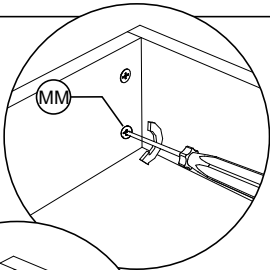
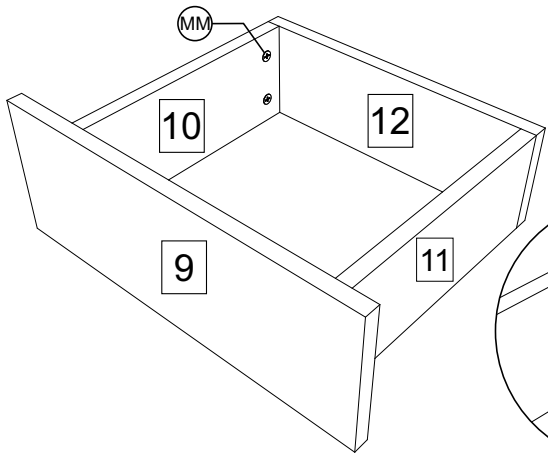

17

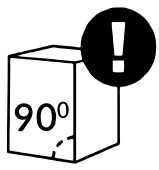
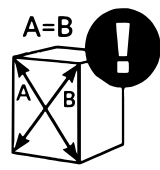
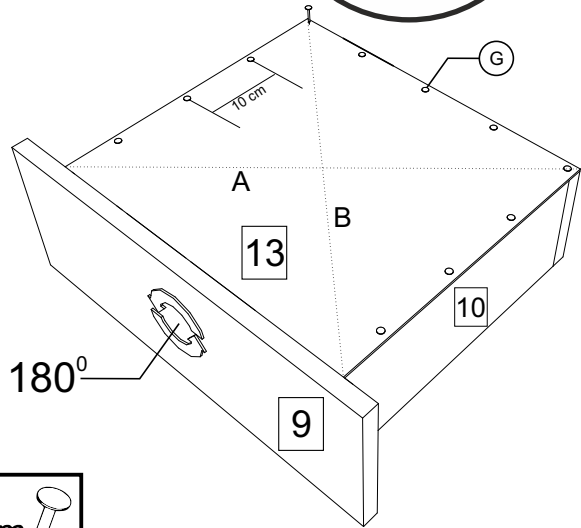
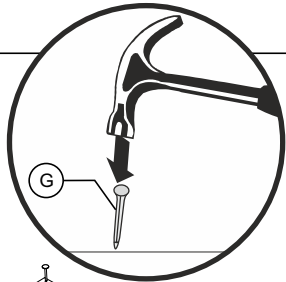
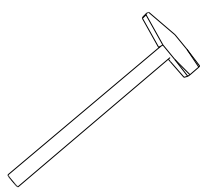
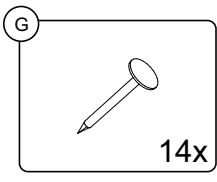

180°

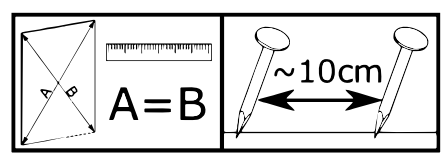

18

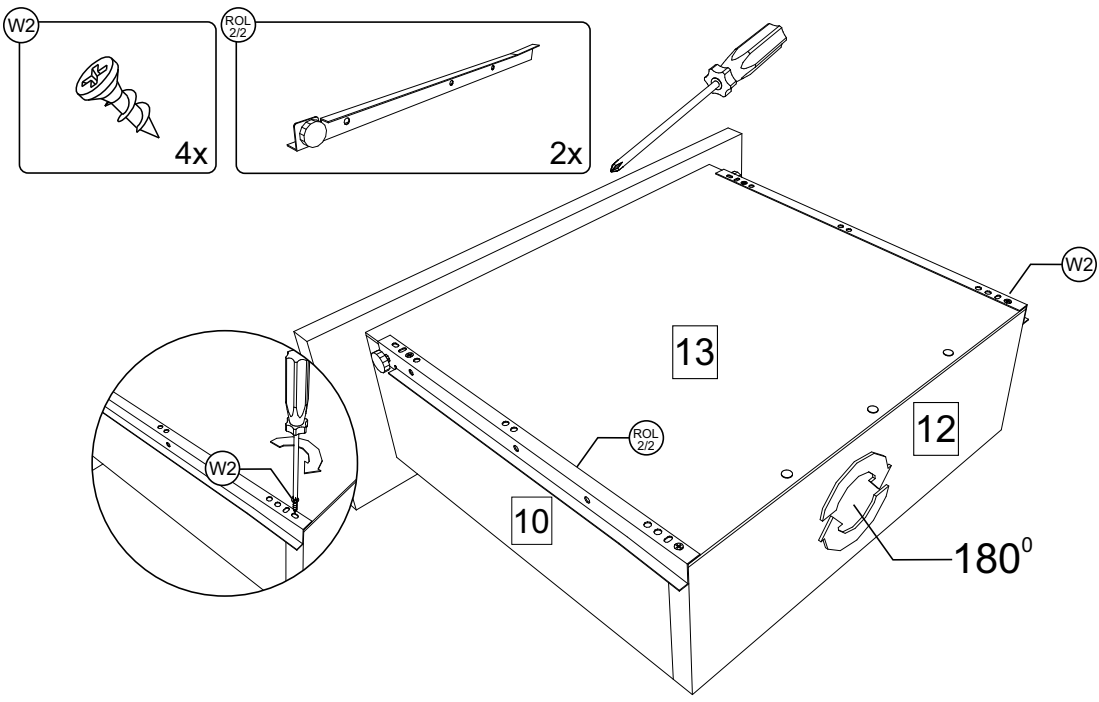

19

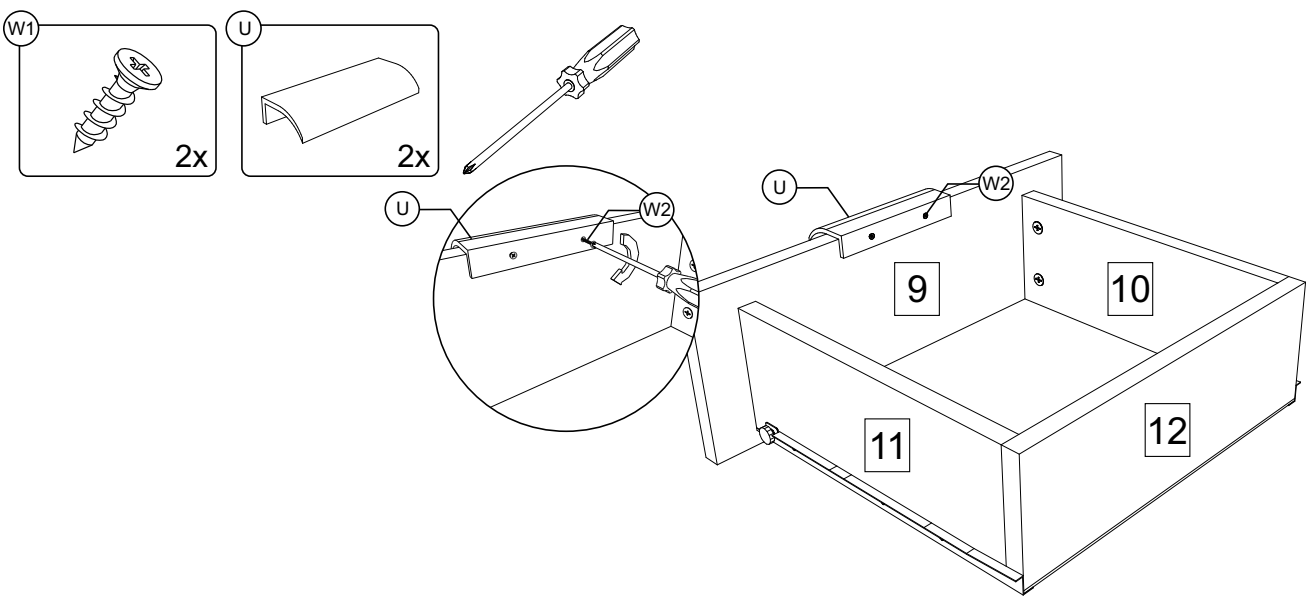

20

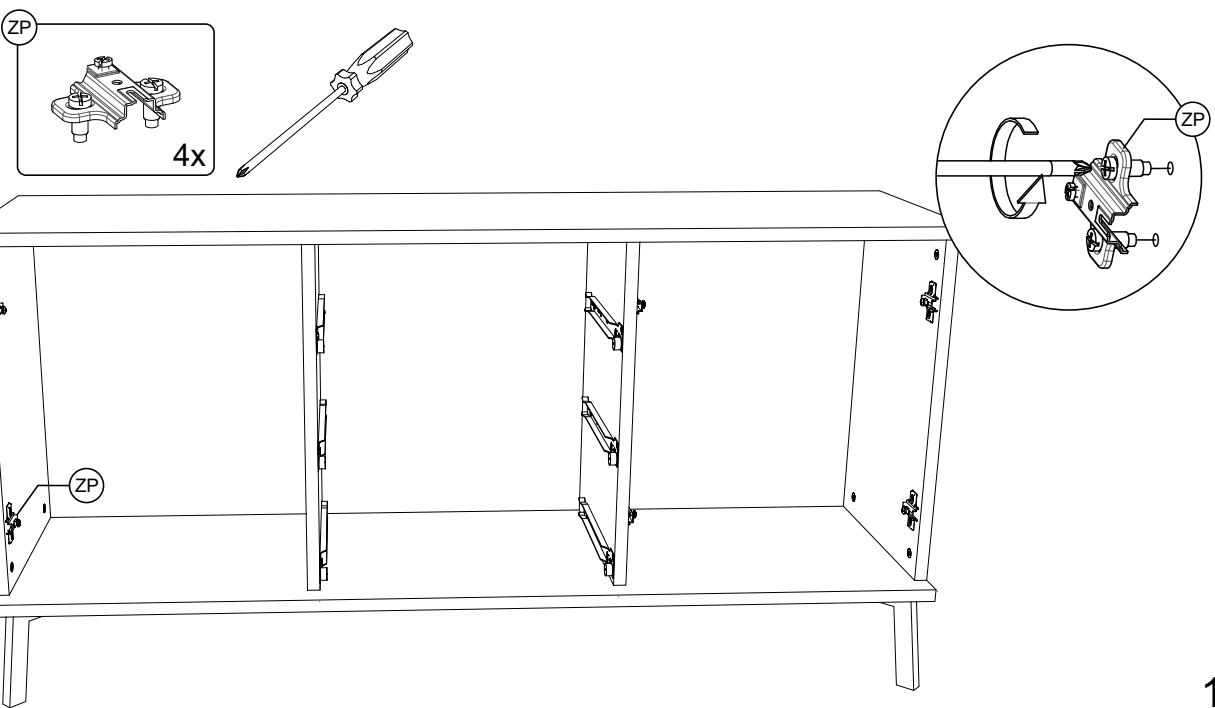

21

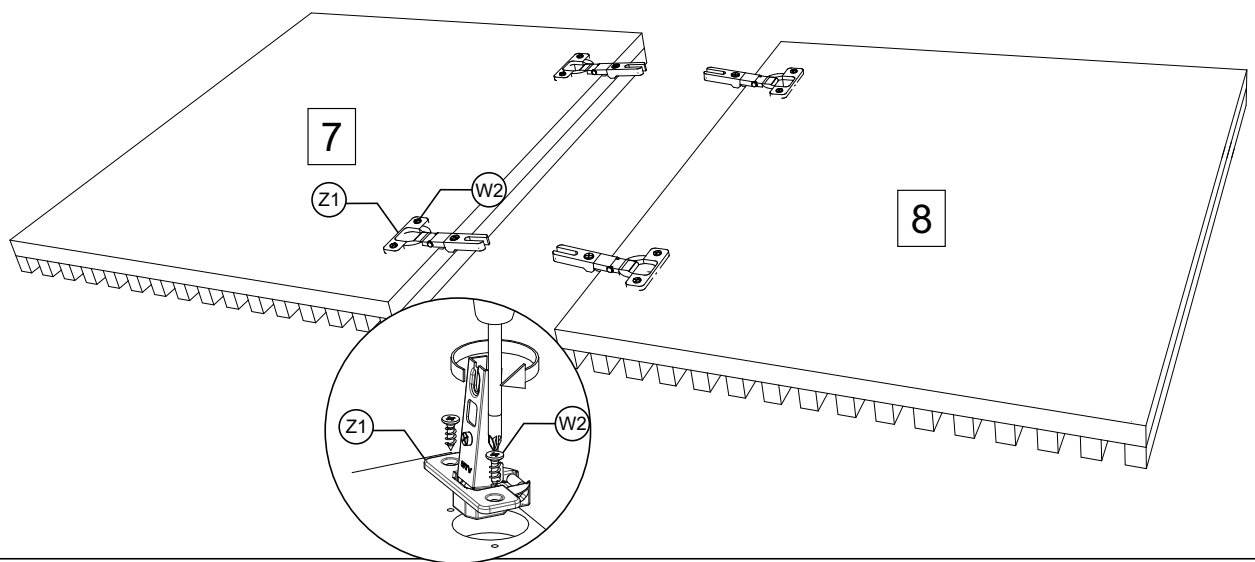
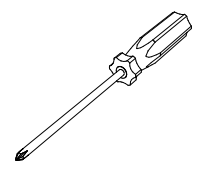
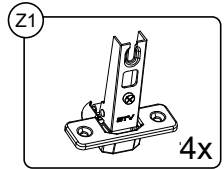
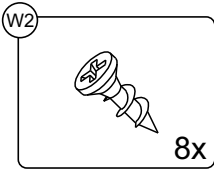

22

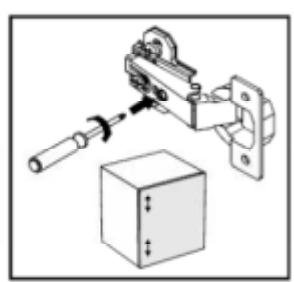
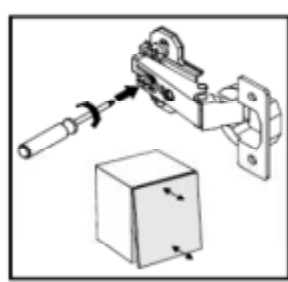
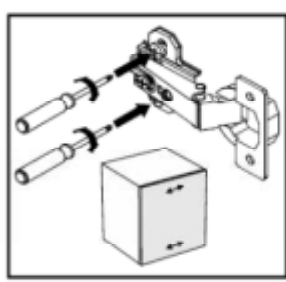
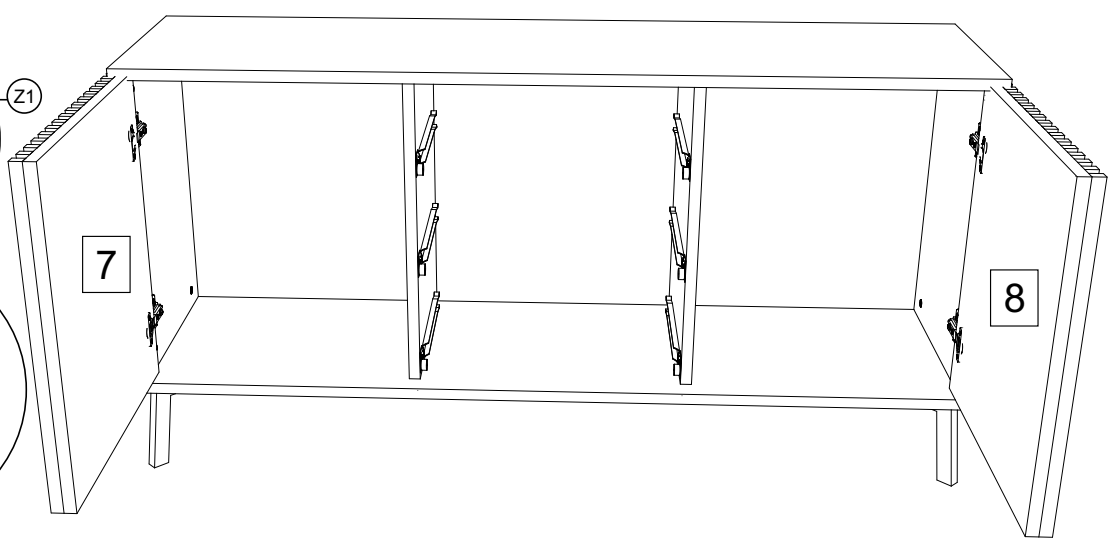
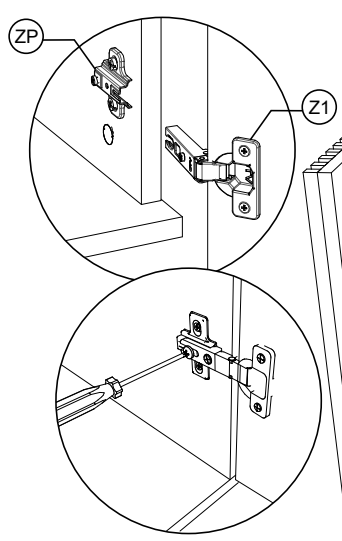

23

