









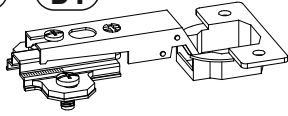

A1 8 x 35 mm x16 	A8 6 x 45 mm x8 	B0 + B1 x4 
C2 5 x 13 mm x14 	D2 x8 	D5 x6 
E0 Ø16 x16 	E1 15 x 12 mm x16 	E4 12 x 10 mm x8 
F1 6 x 34 mm x16 	F3 7 x 64 mm x4 	H1 x1 L - 84 mm 
I2 4 x 16 mm x10 	N1 3 x 16 mm x10 	N5 3,5 x 16 mm x4 
P8B x2 	P9A L R x1 	P9B L R x1 
P15 x3 	P16 x8 	R1 x4 
R2 x6 	R3 x10 	R4 x10 
R8 x2 	S13 x4 Ø8 	

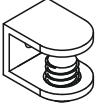
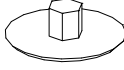

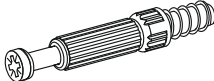
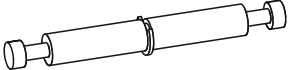
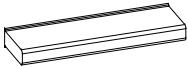
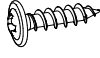

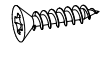
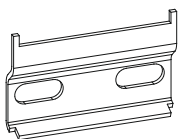
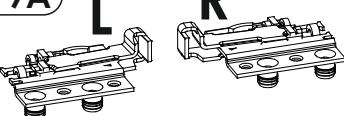
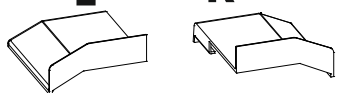
1	452	400	22	x1	1/2
2	450	380	16	x1	1/2
3	1700	380	16	x1	2/2
4	419	380	16	x1	2/2
5	878	136	16	x1	1/2
6	403	380	16	x1	2/2
7	926	262	4	x1	2/2
8	416	360	16	x2	2/2
9	415	345	16	x2	2/2

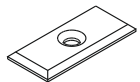
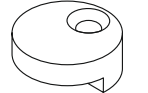
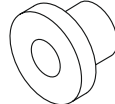
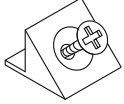
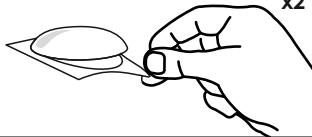
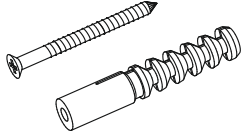
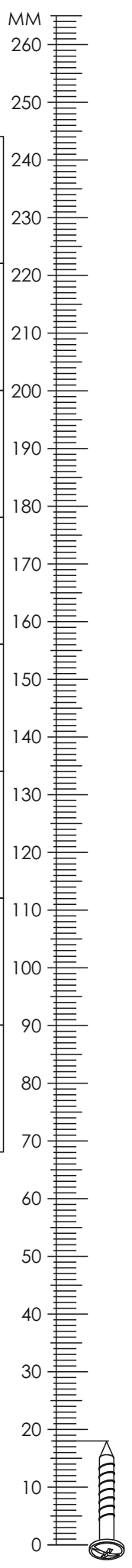
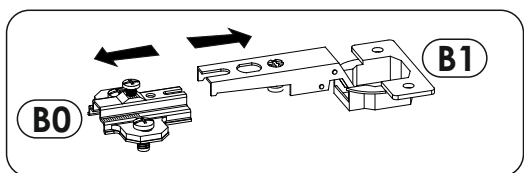
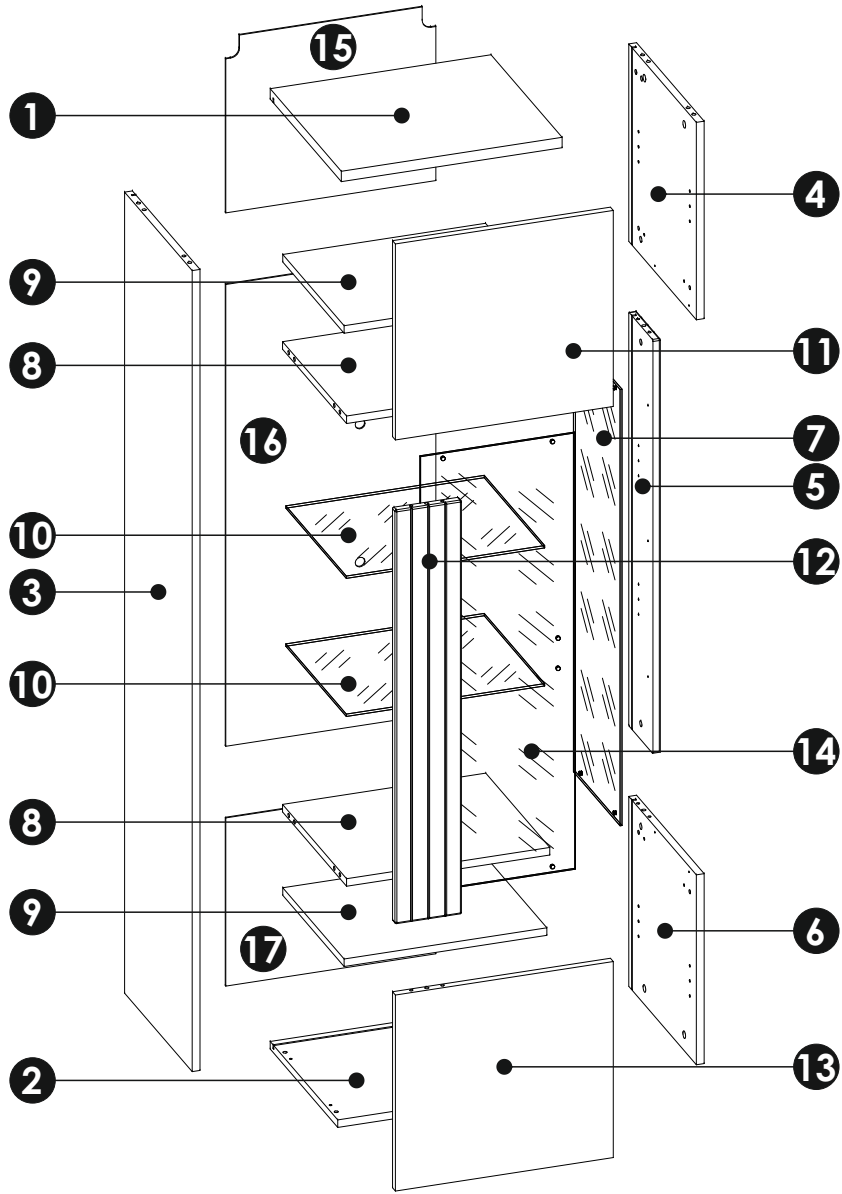
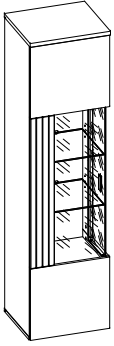
10	406	340	5	x2	1/2
11	416	446	16	x1	1/2
12	878	136	16	x1	1/2
13	416	446	16	x1	1/2
14	926	317	4	x1	2/2
15	373	430	3	x1	2/2
16	980	430	3	x1	1/2
17	357	430	3	x1	2/2

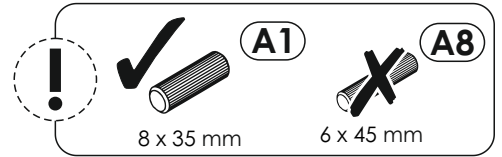
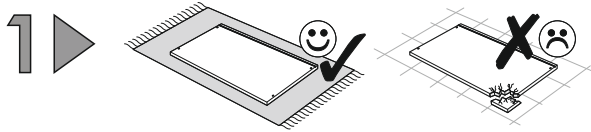
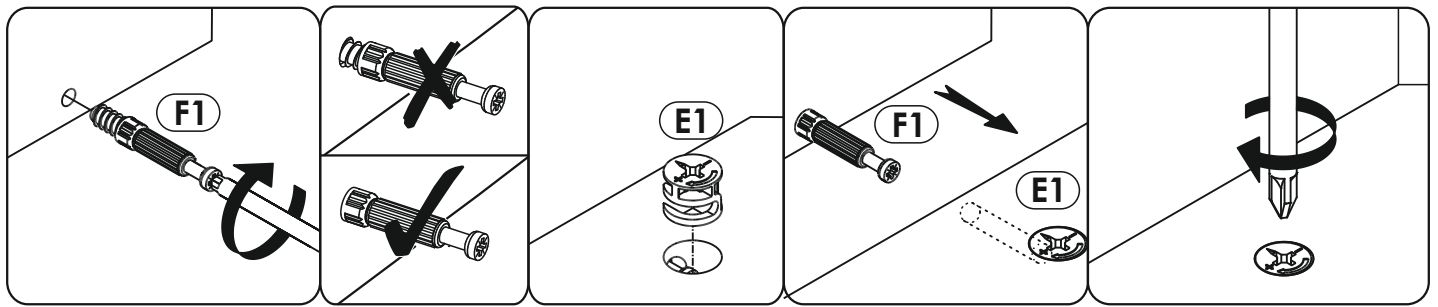

a)

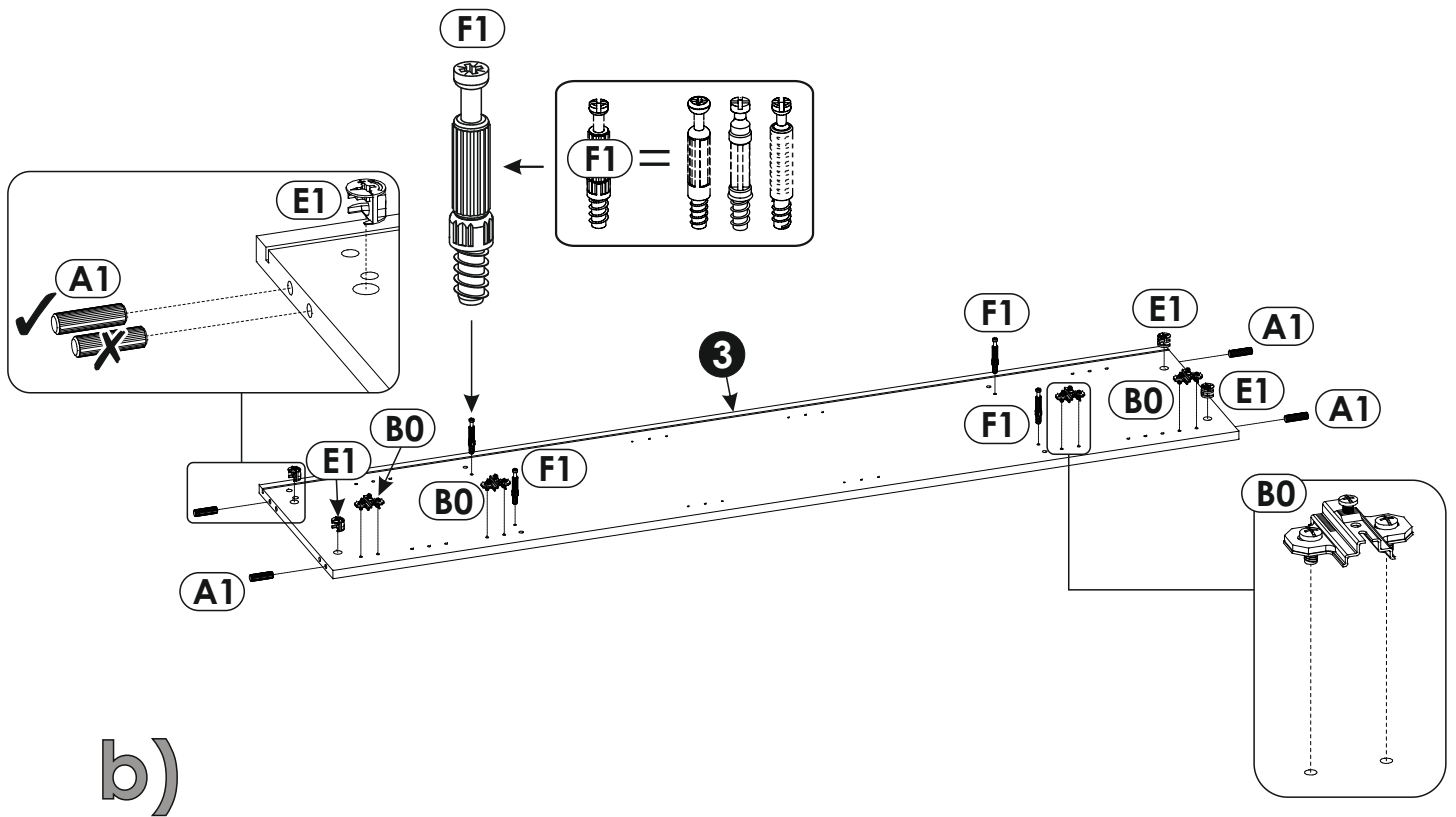
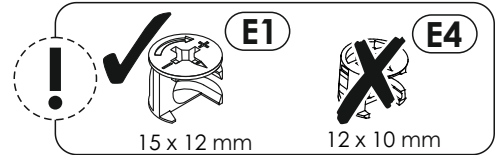
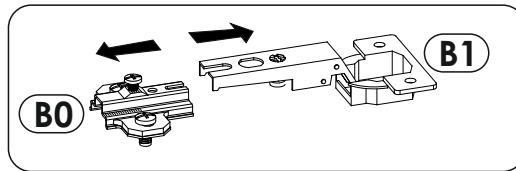

b)

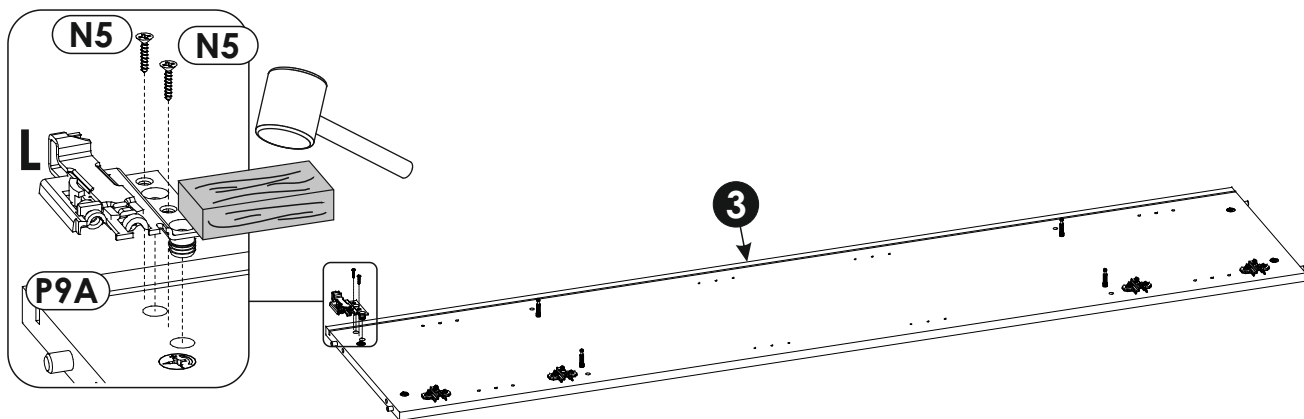

2 ▶

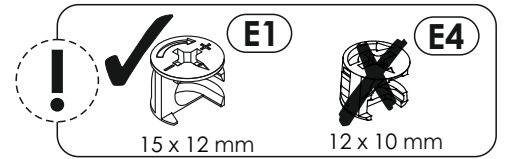
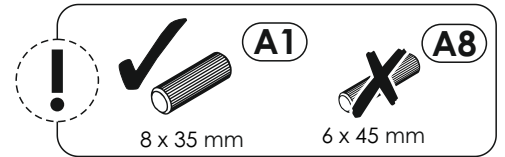
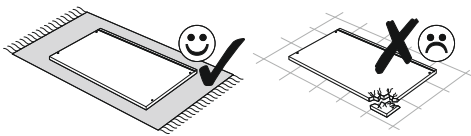

x2

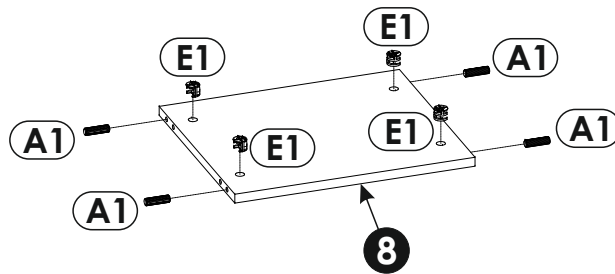

3 ▶

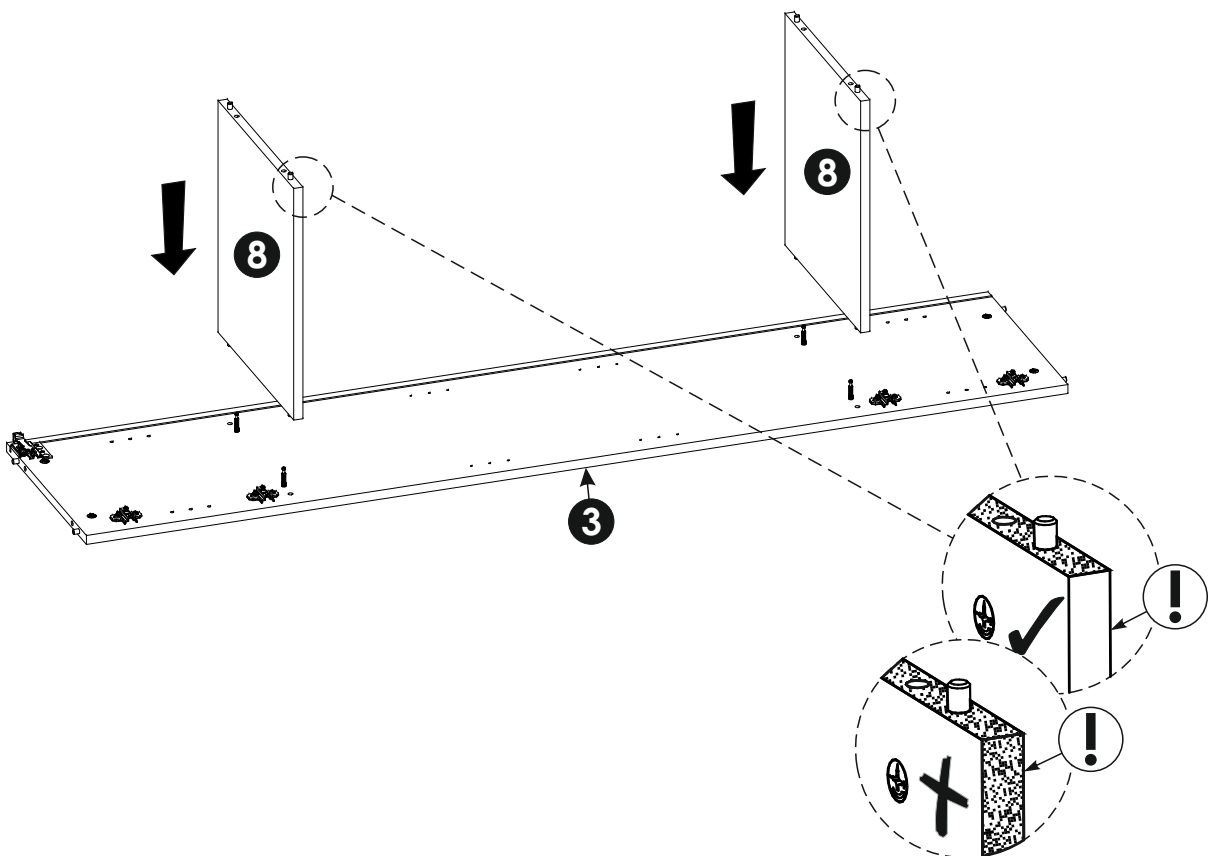
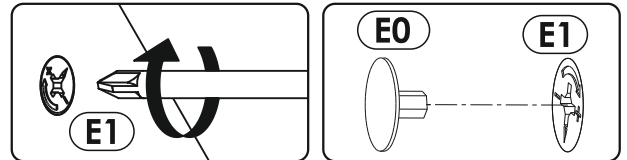
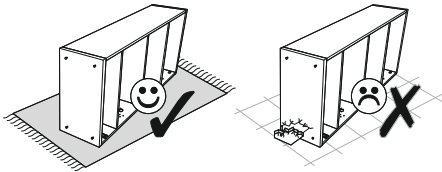

4 ▶

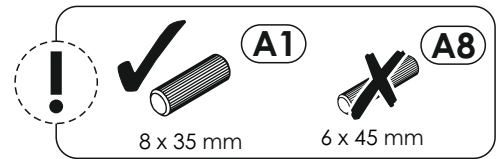
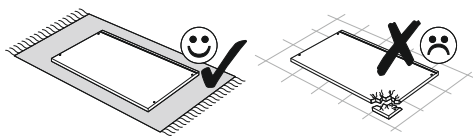

a)

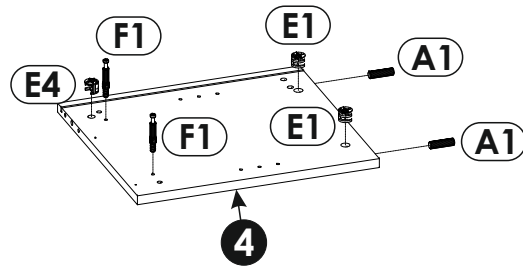
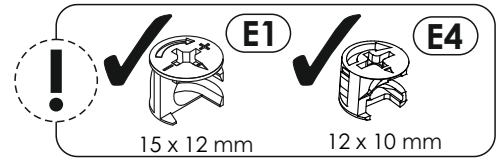

b)

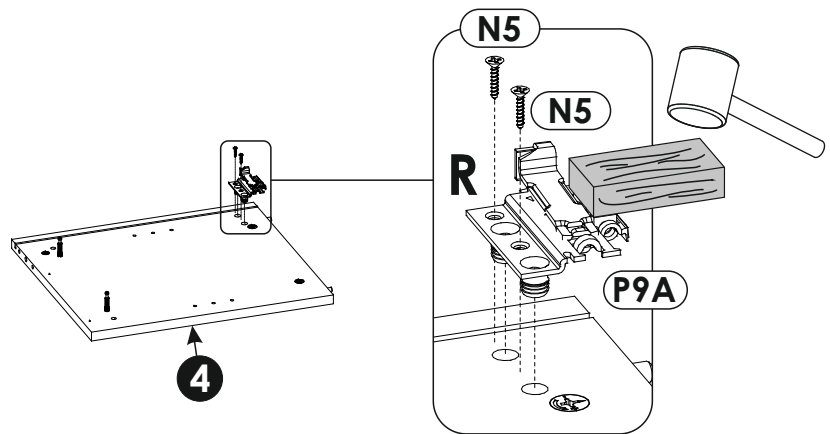

5 ▶

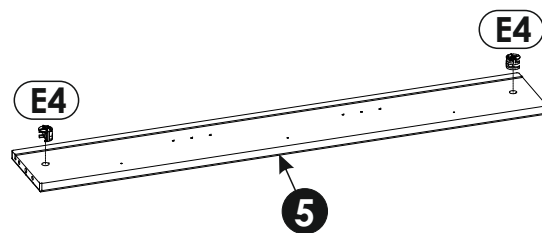
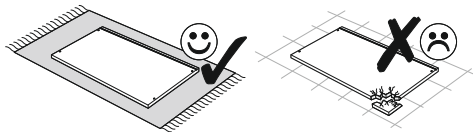

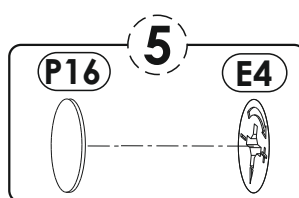
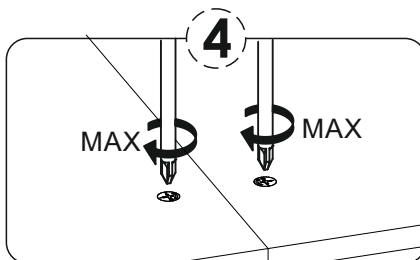
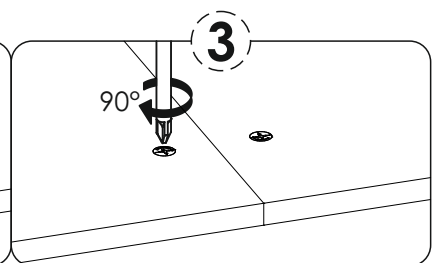
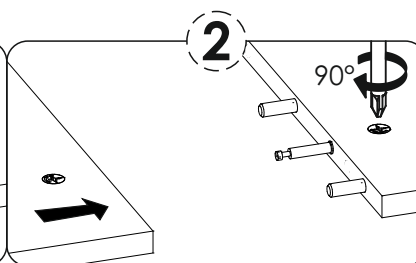
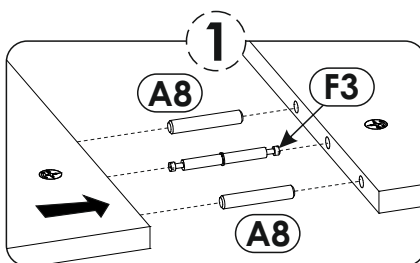
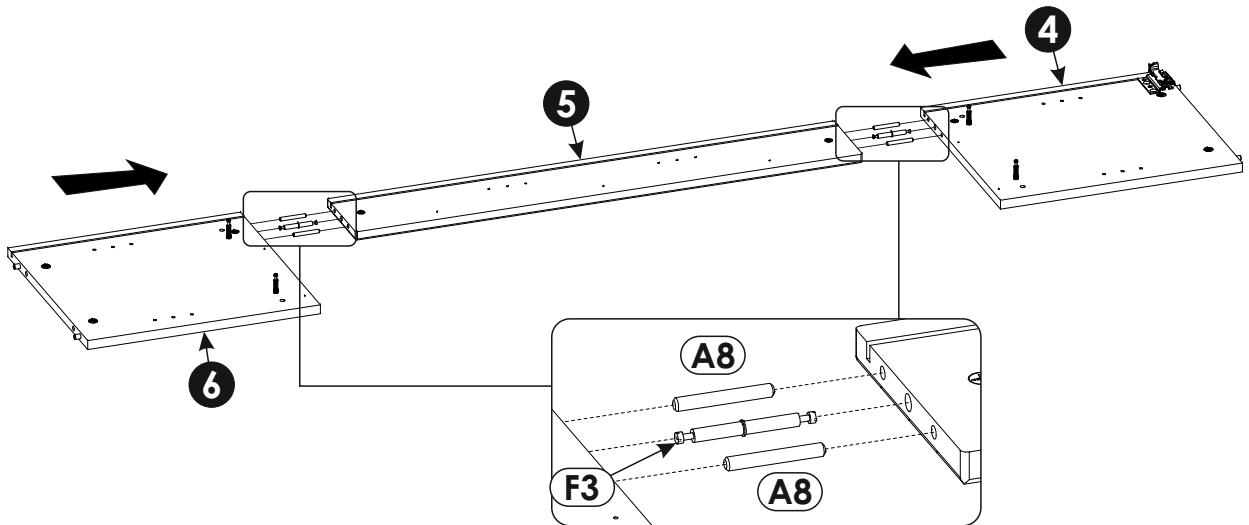
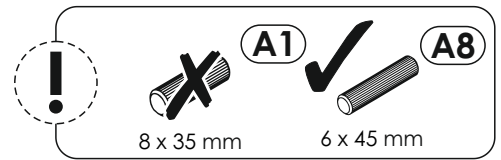
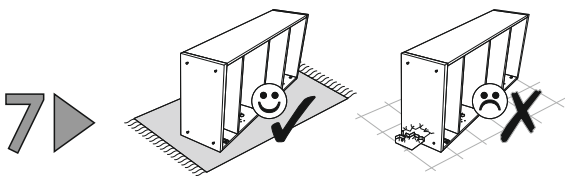
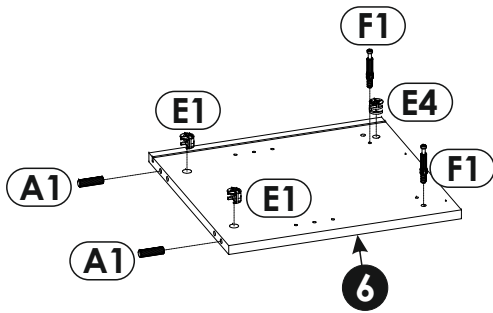
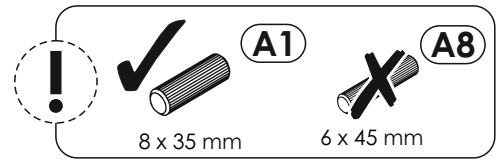
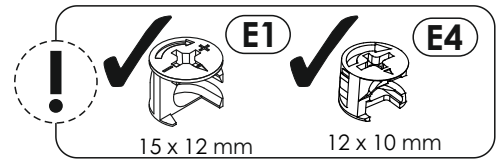
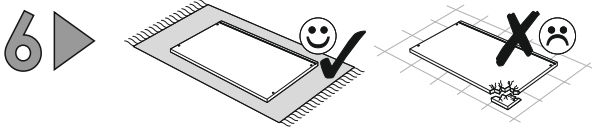

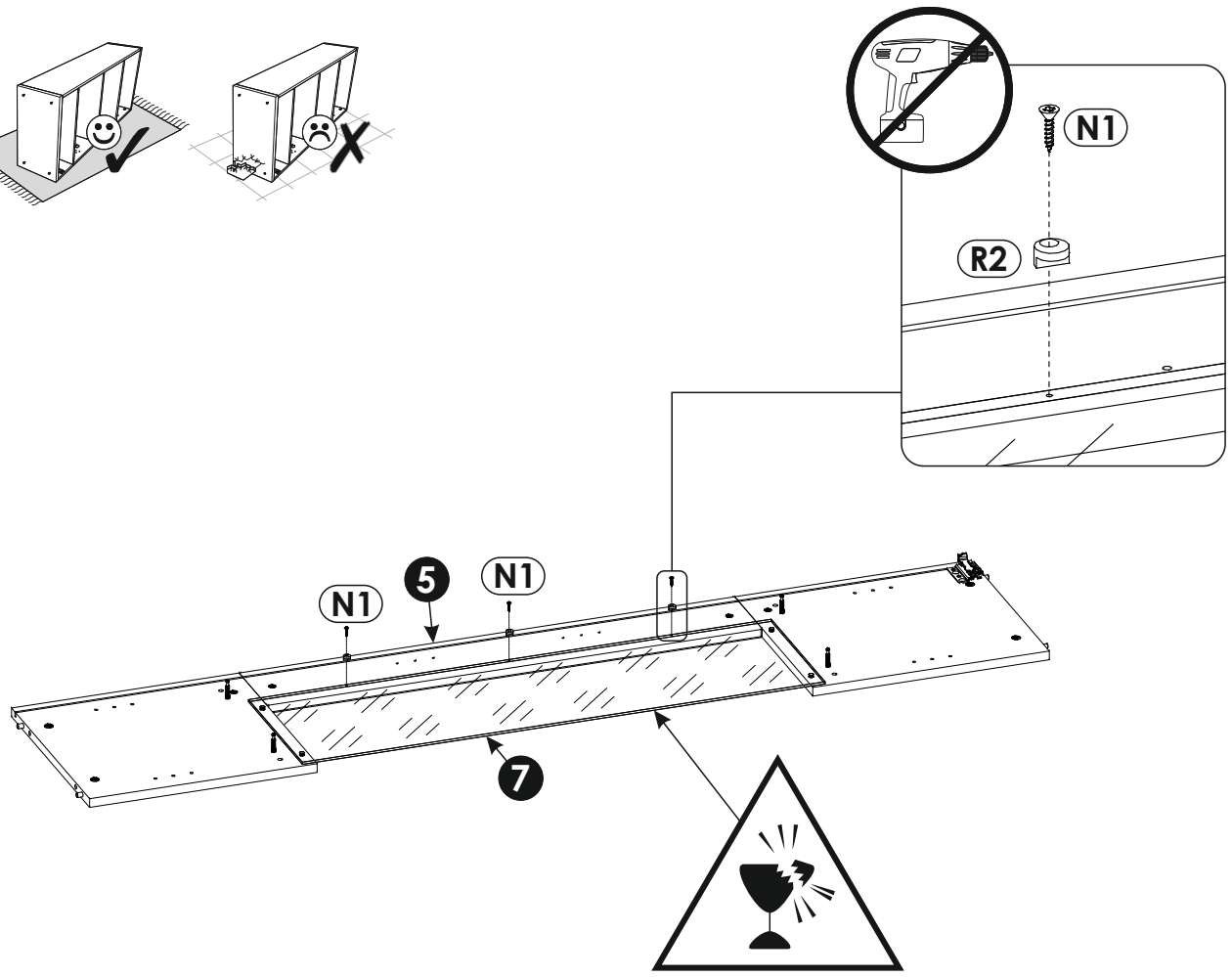
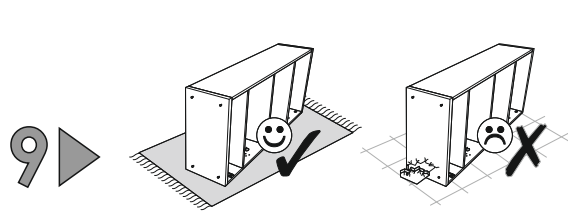
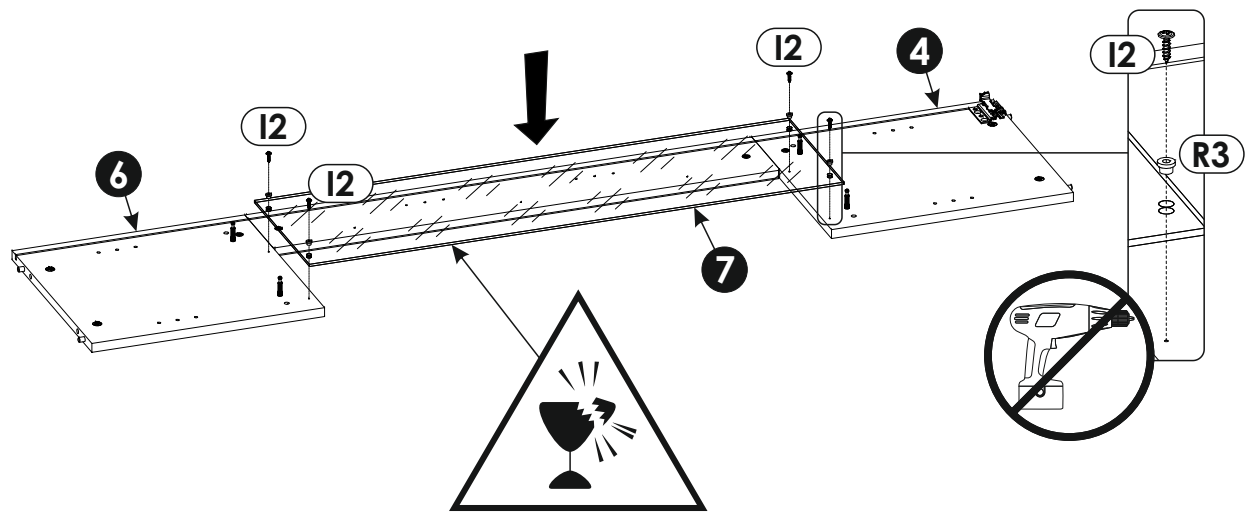
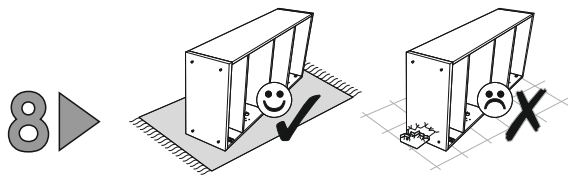

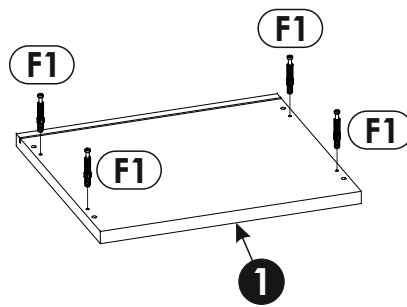
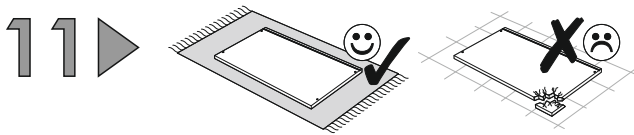
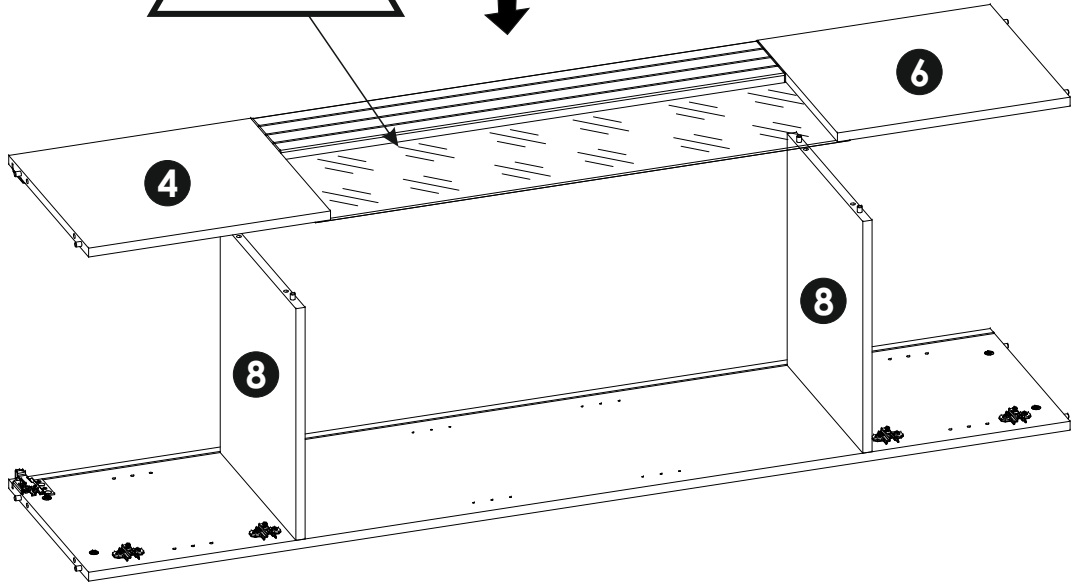
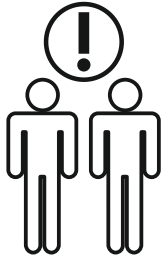
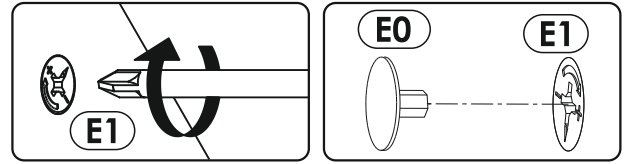
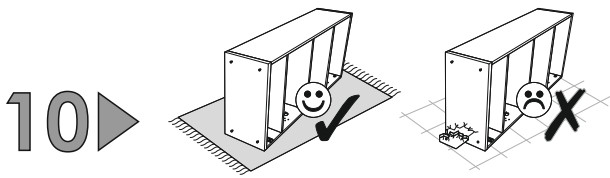

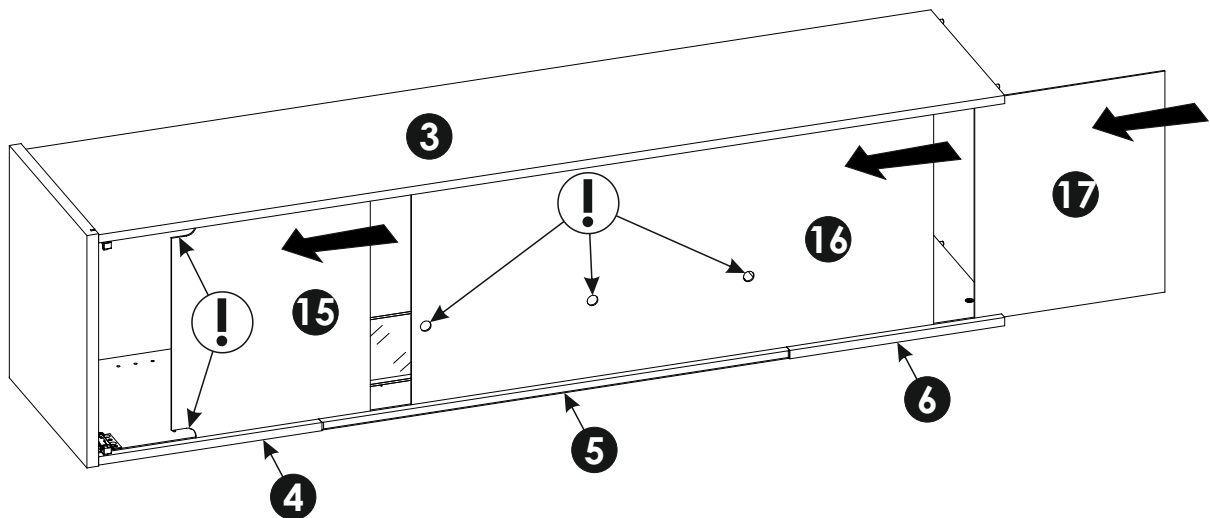
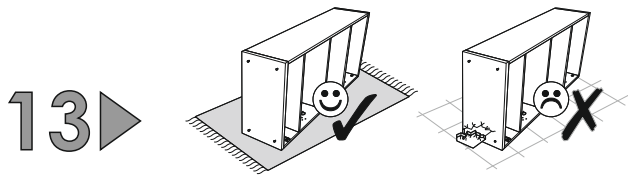
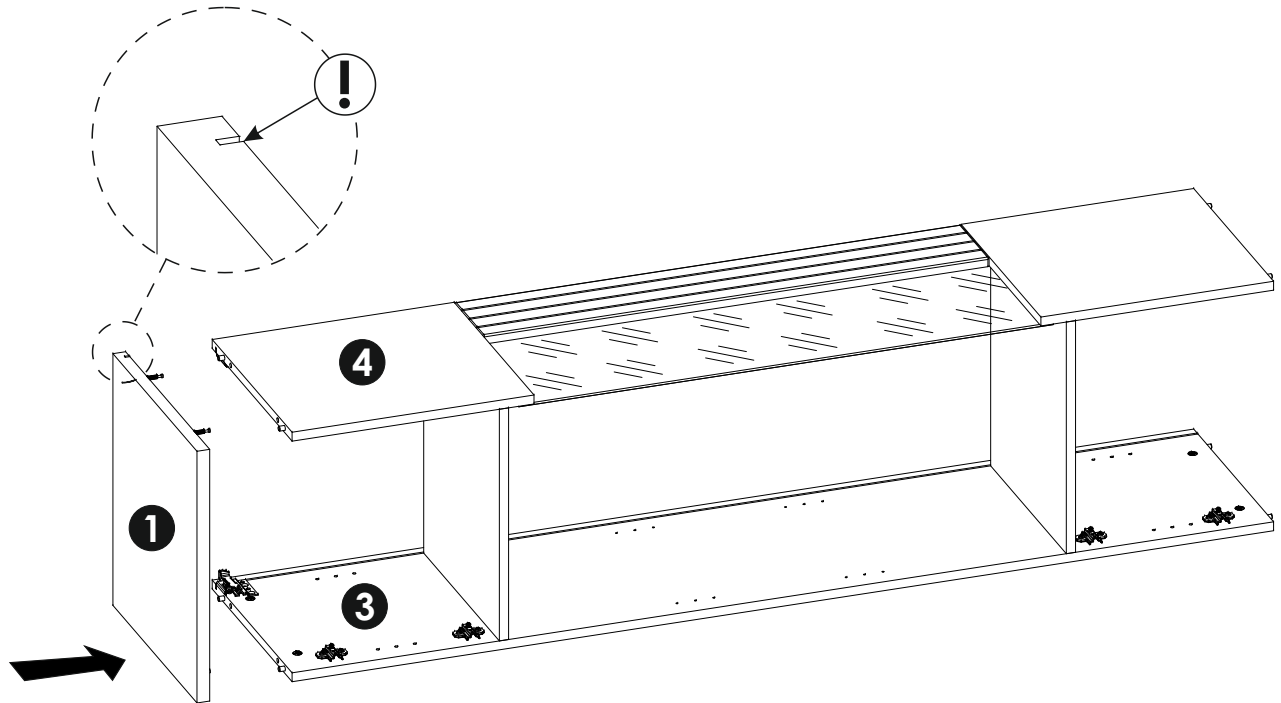
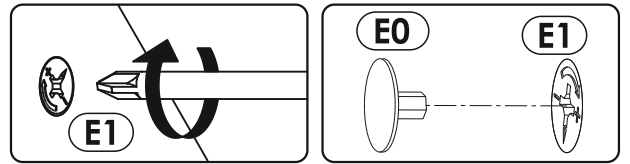
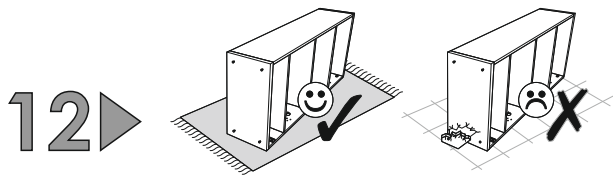

14▶

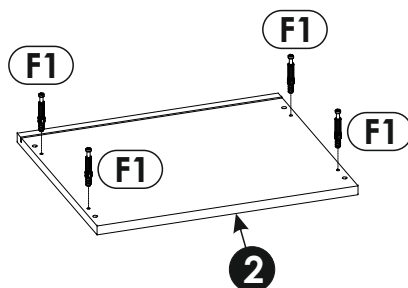
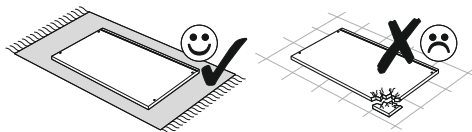

15▶

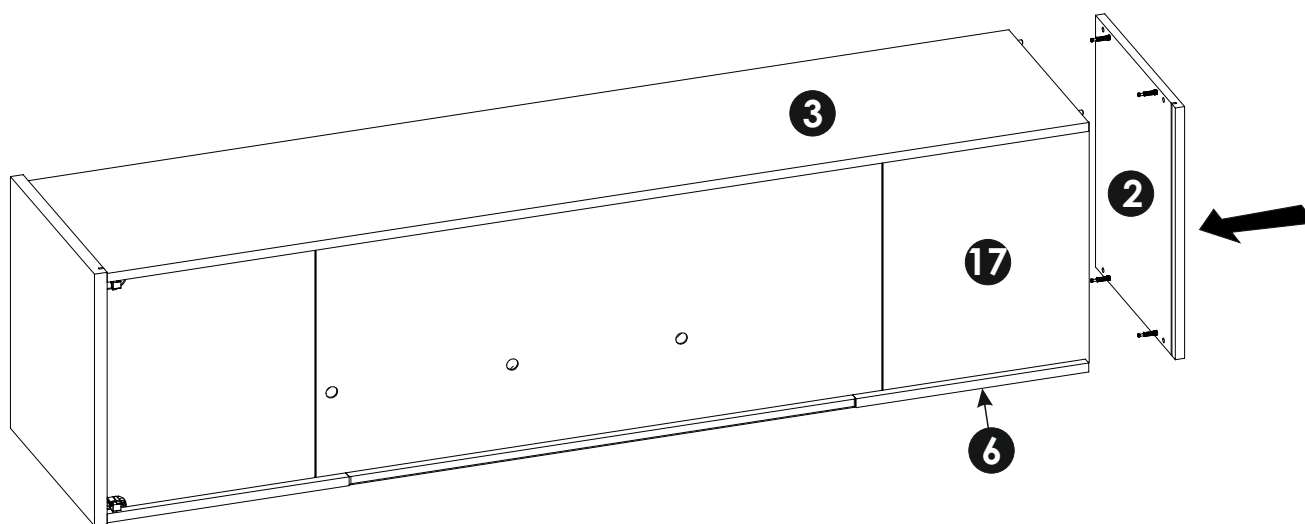
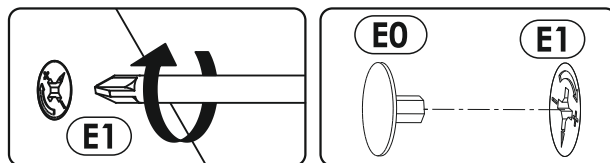
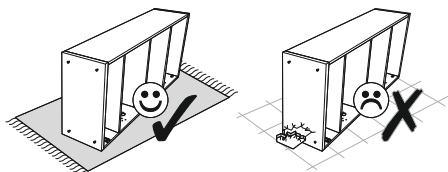

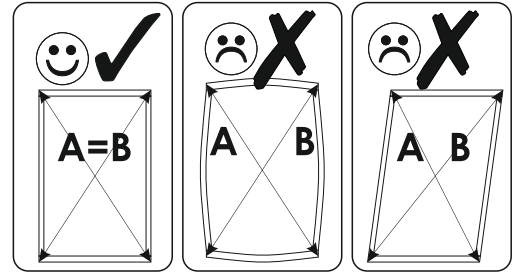
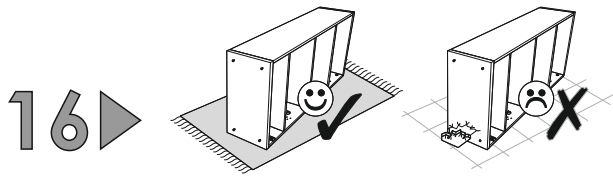

A=B

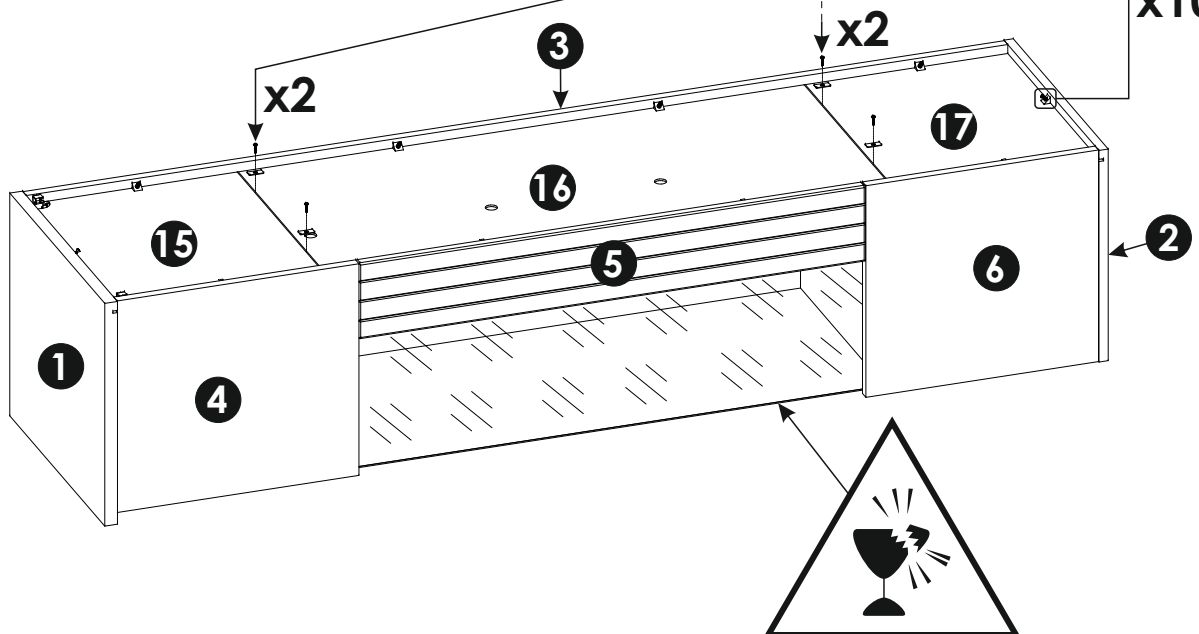
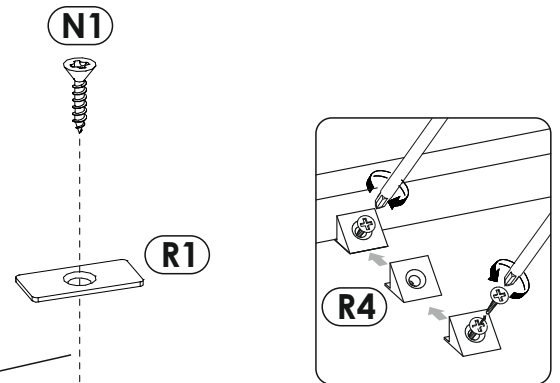
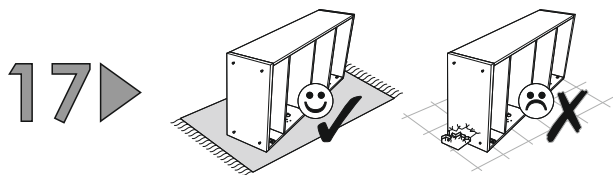
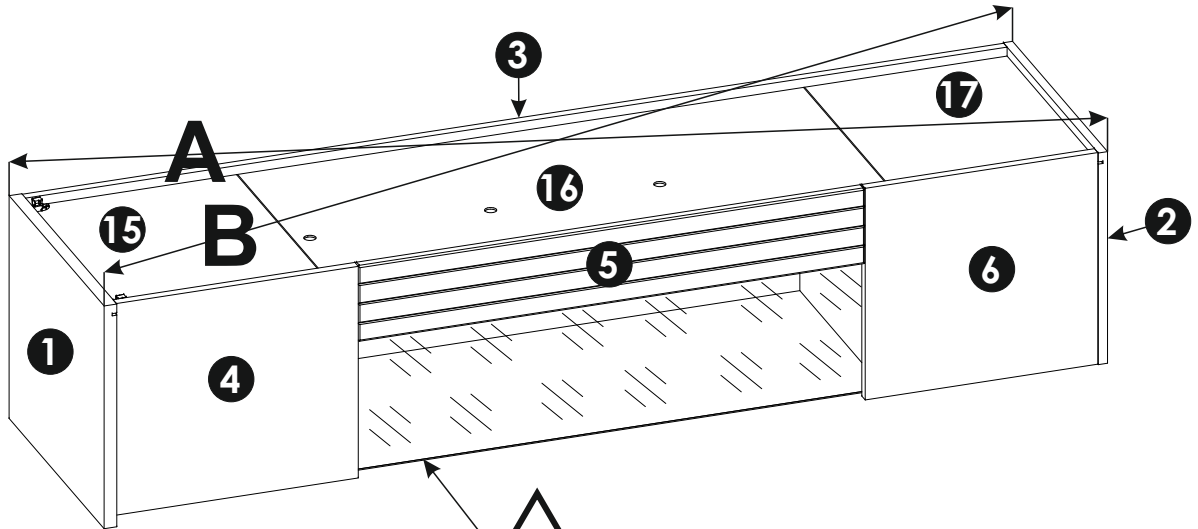

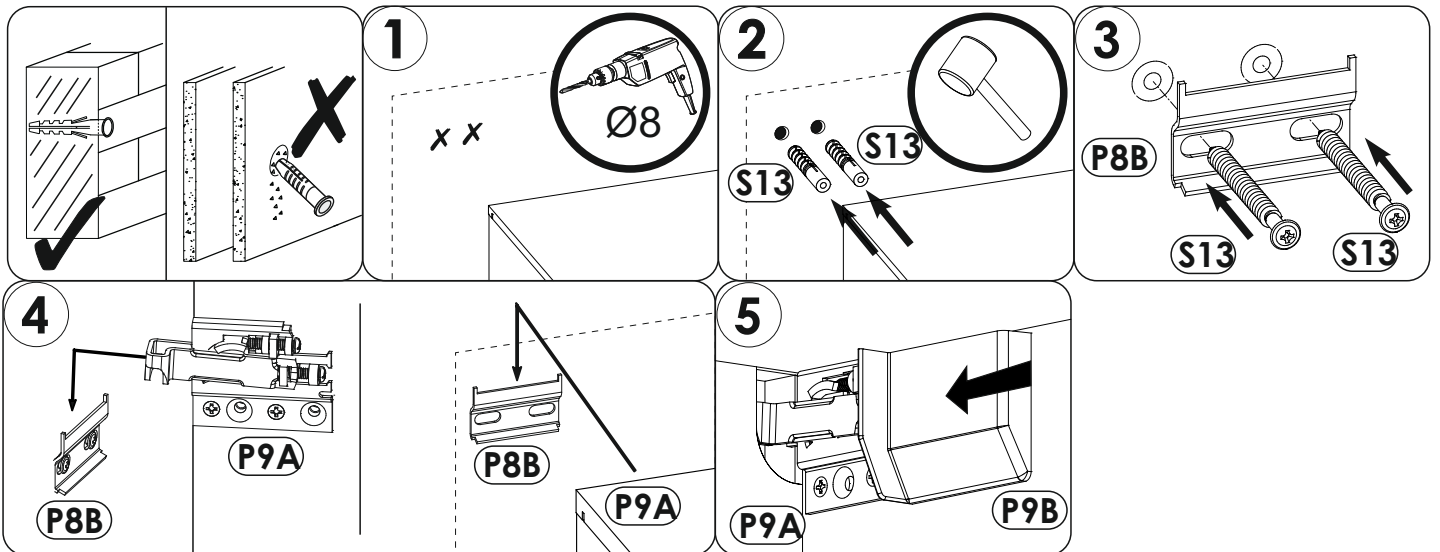
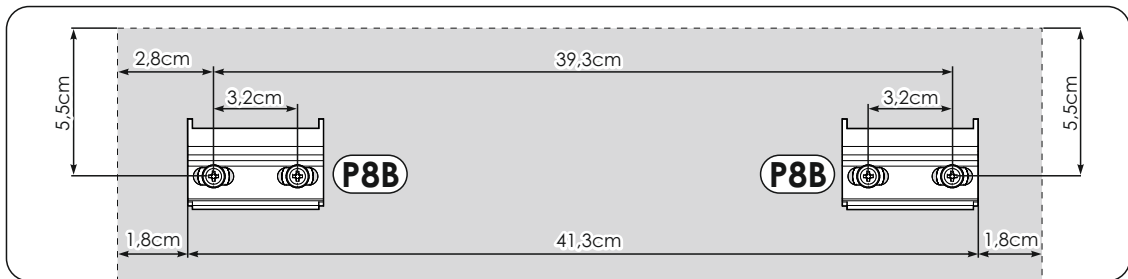
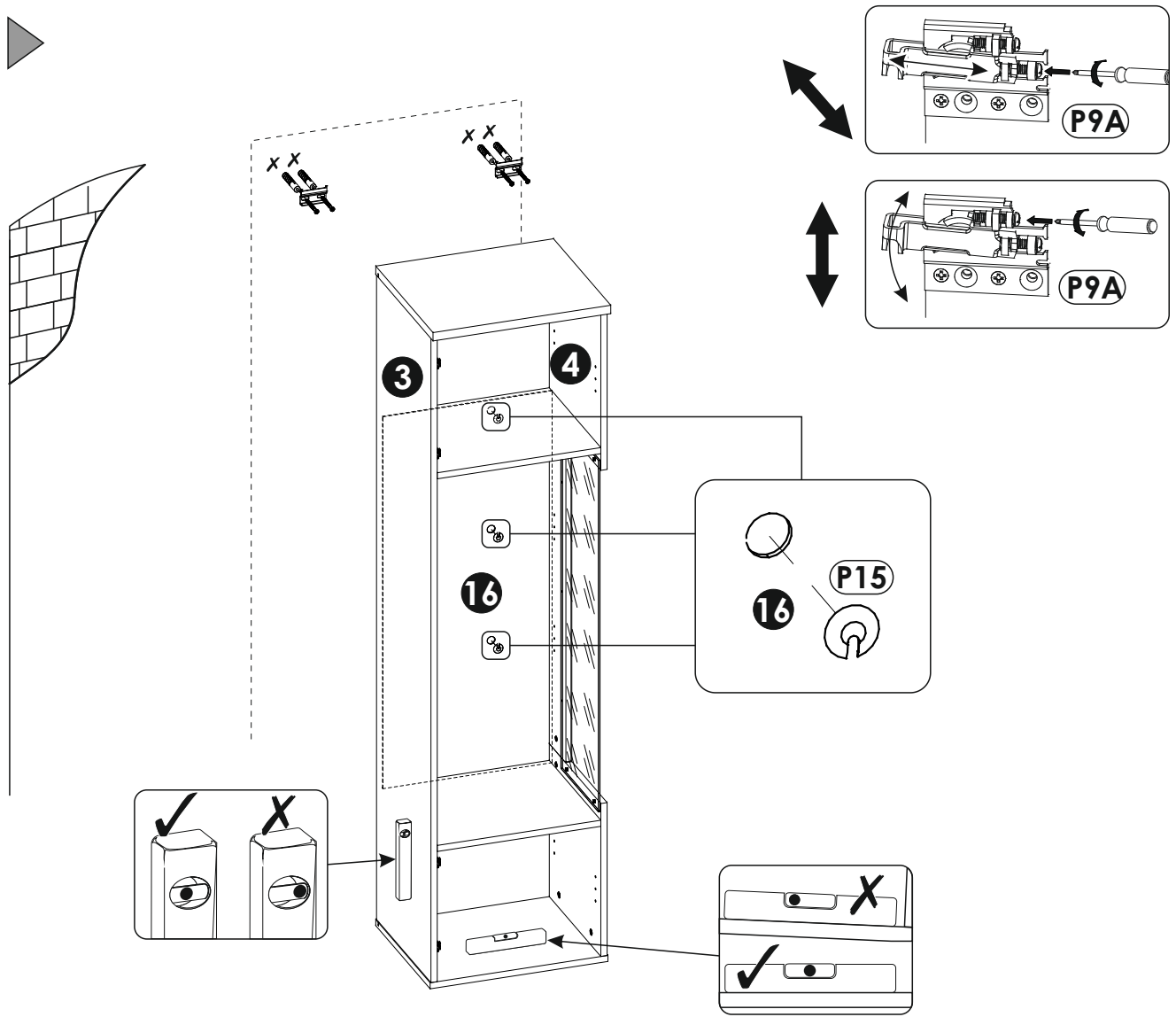

19▶

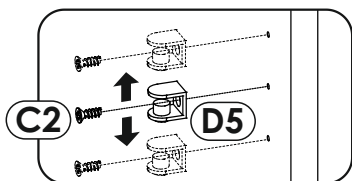
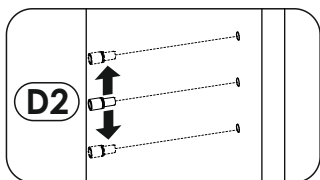
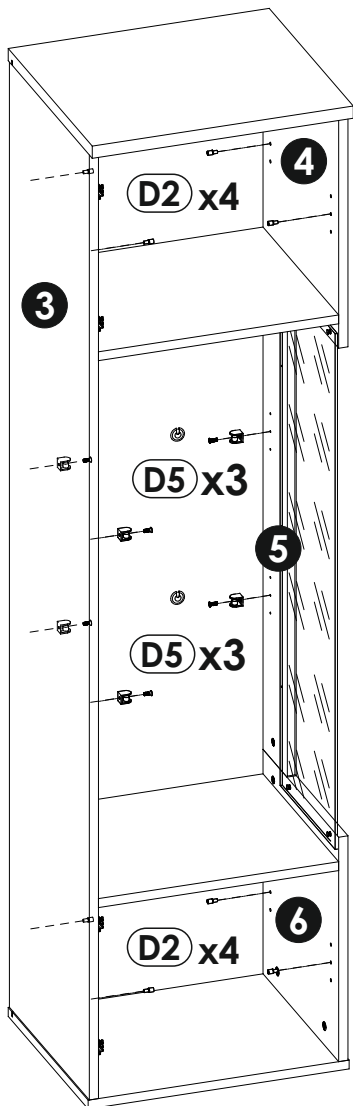

20▶

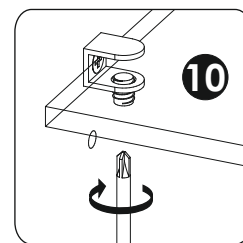
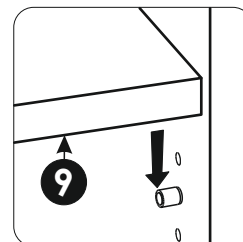
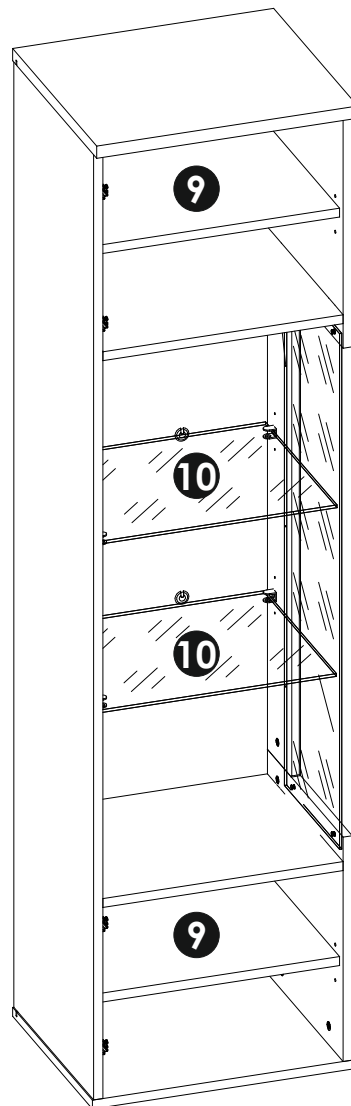

21 ▶

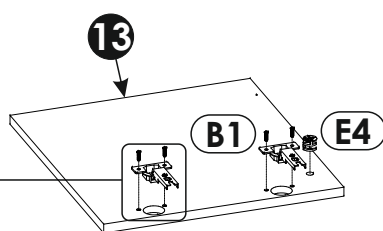
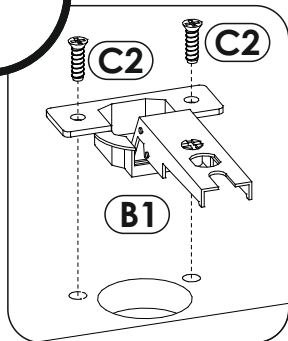
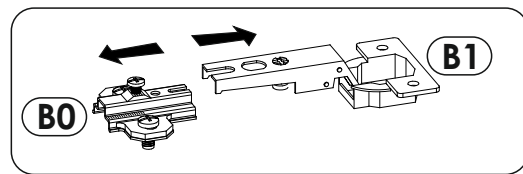
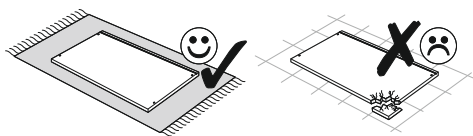

22 ▶

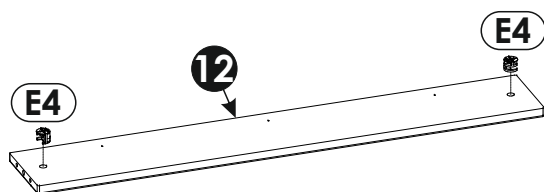
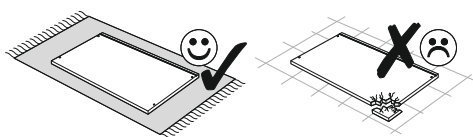

23 ▶

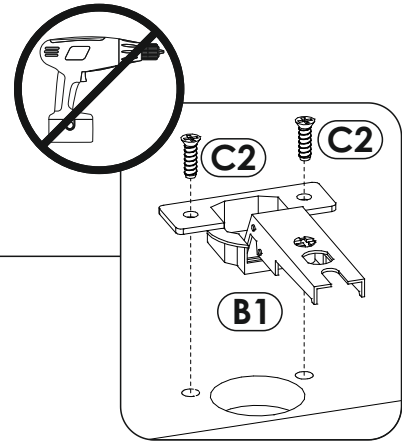
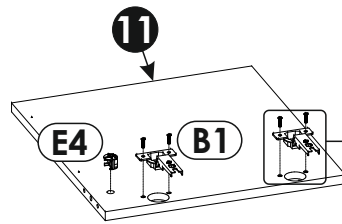
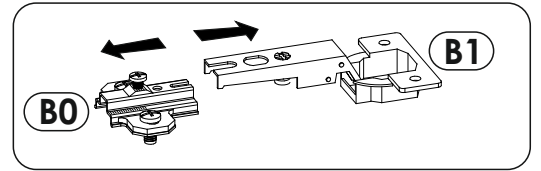
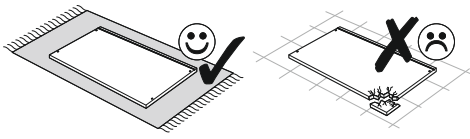

24 ▶

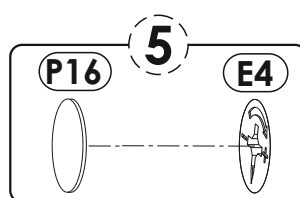
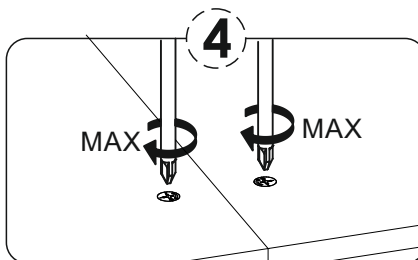
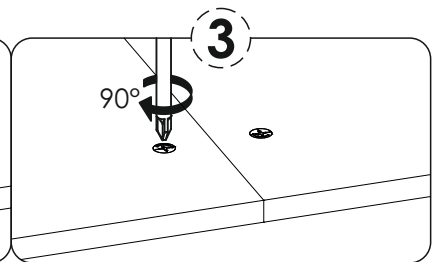
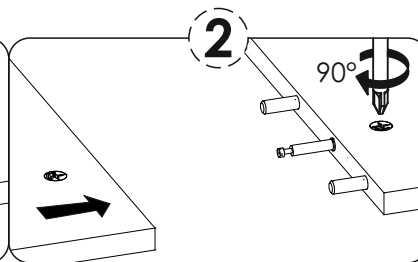
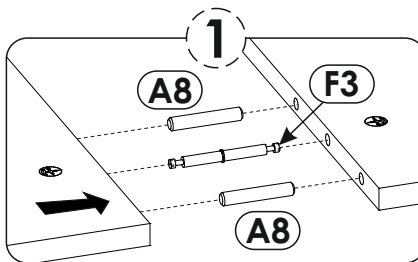
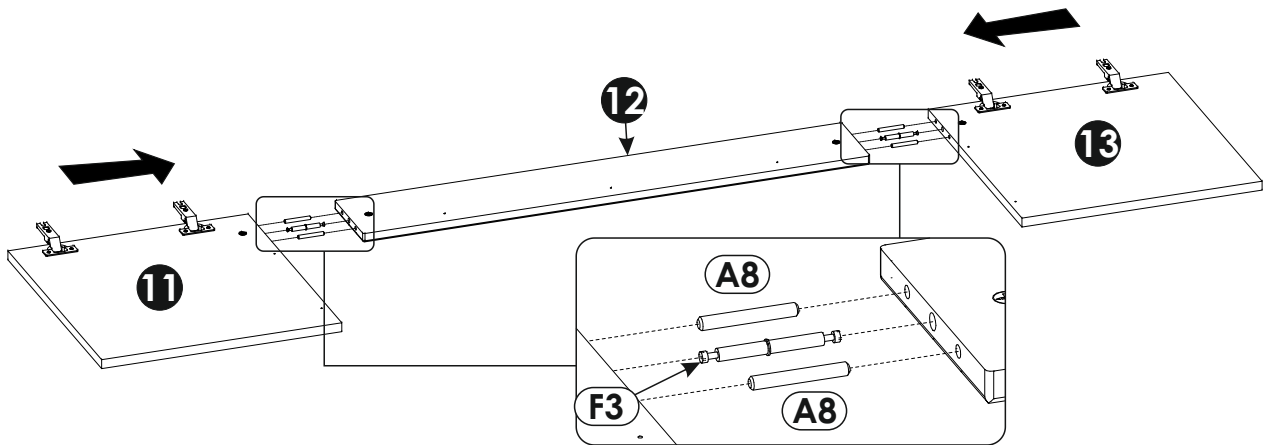
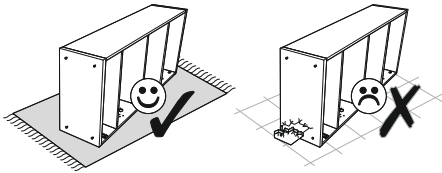

25 ▶

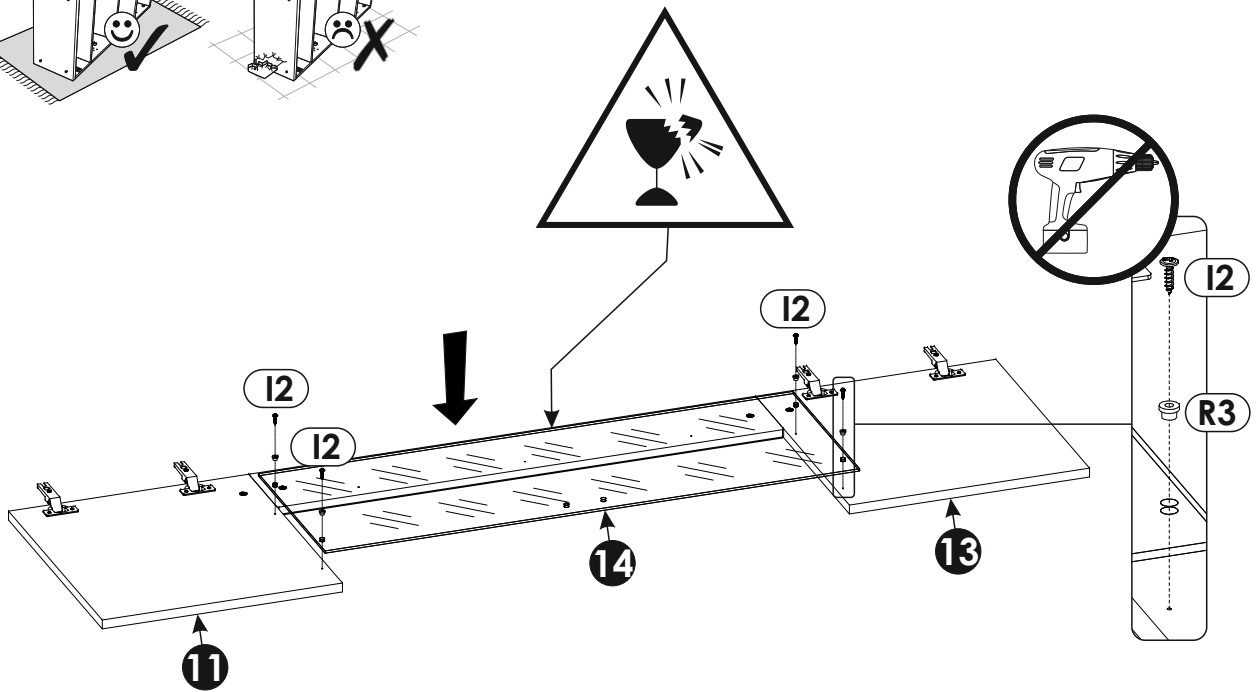
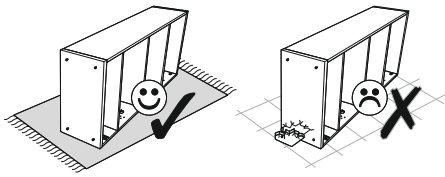

26 ▶

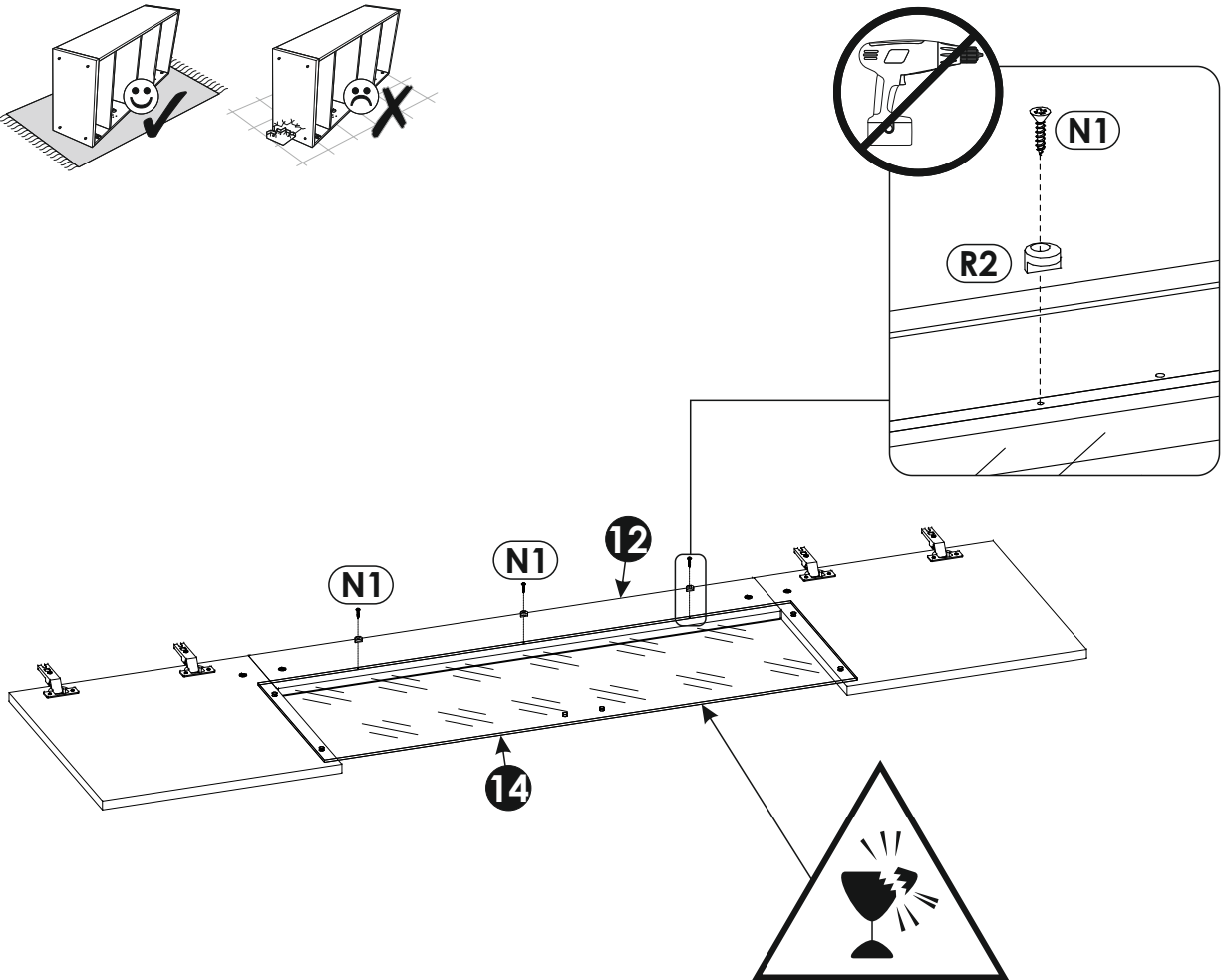
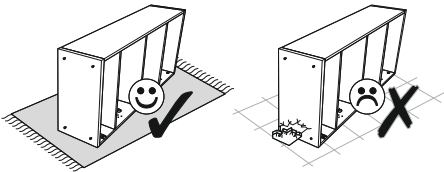

27▶

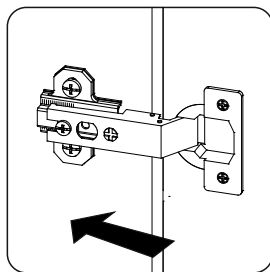
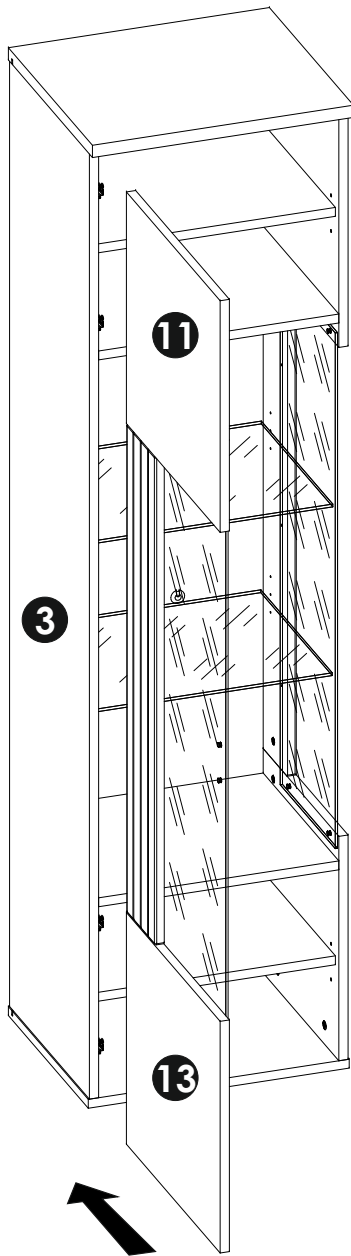

28▶

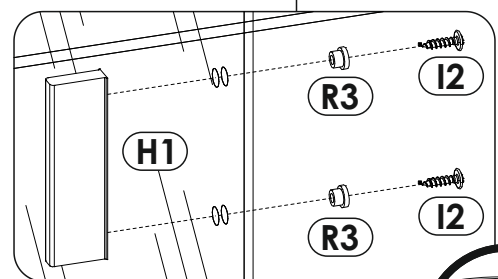
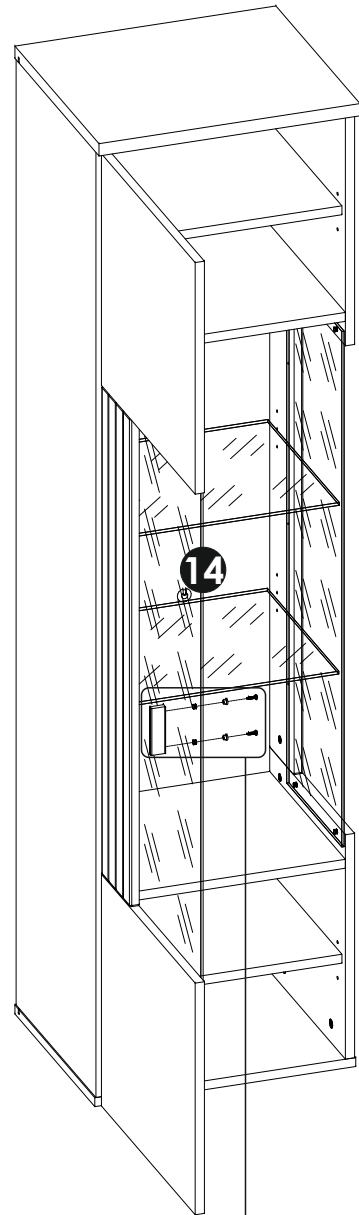

29 ▶

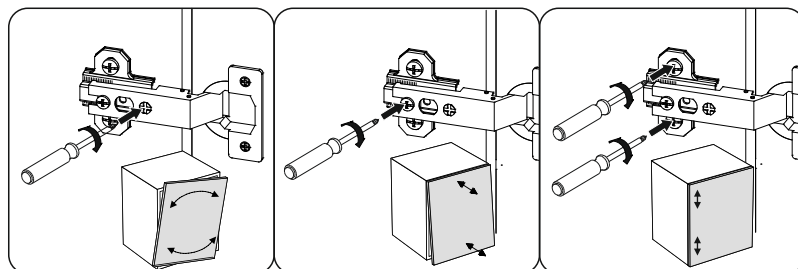
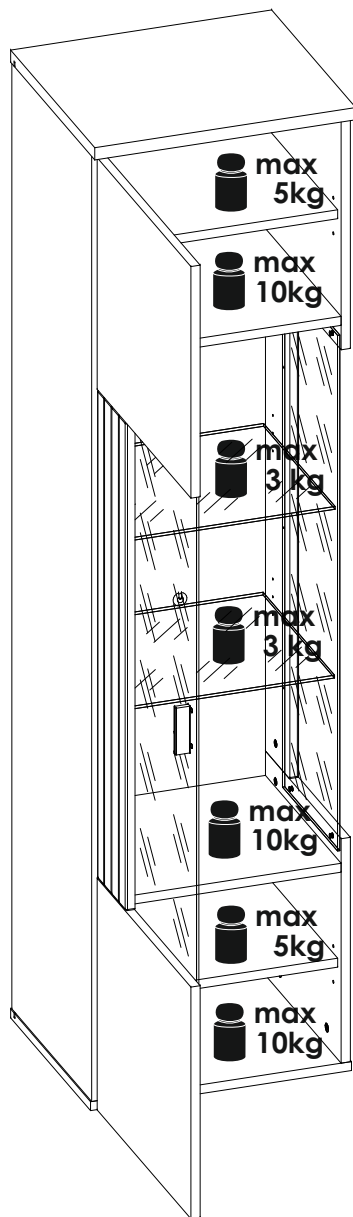

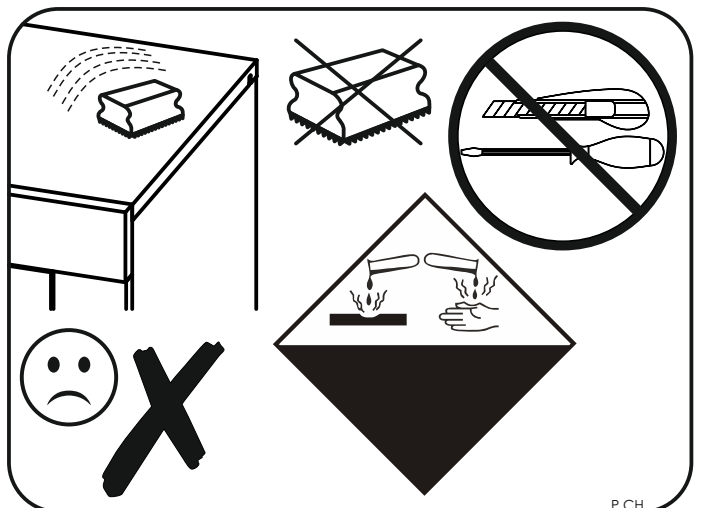
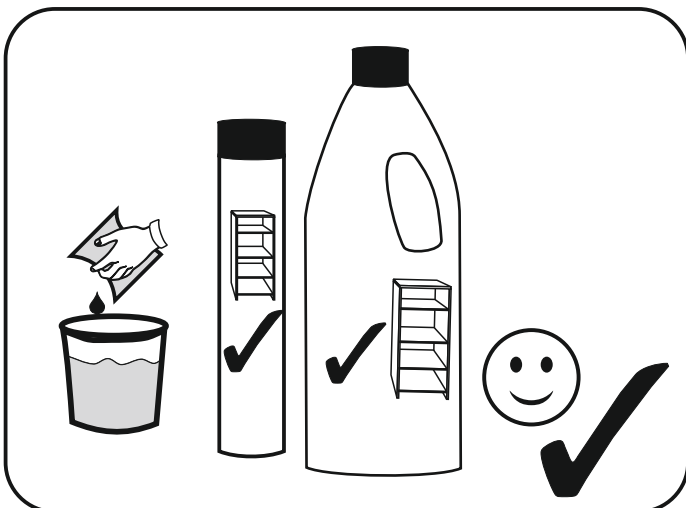
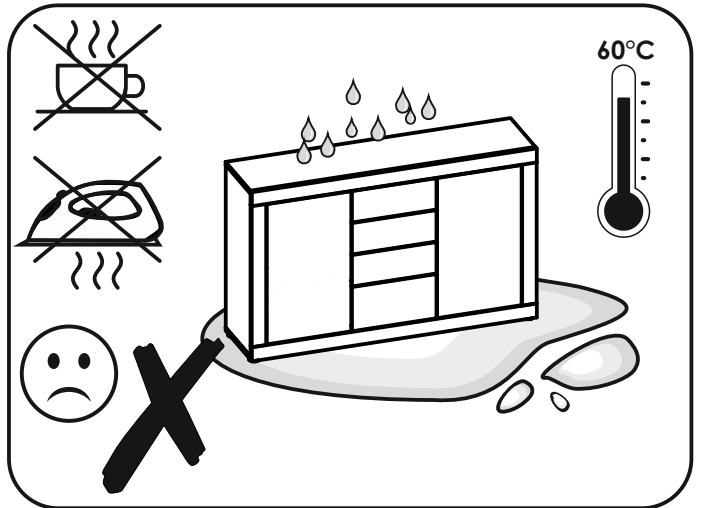
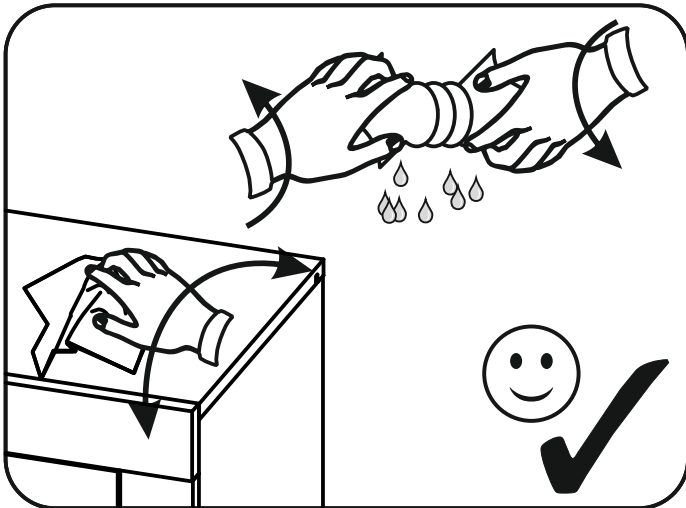
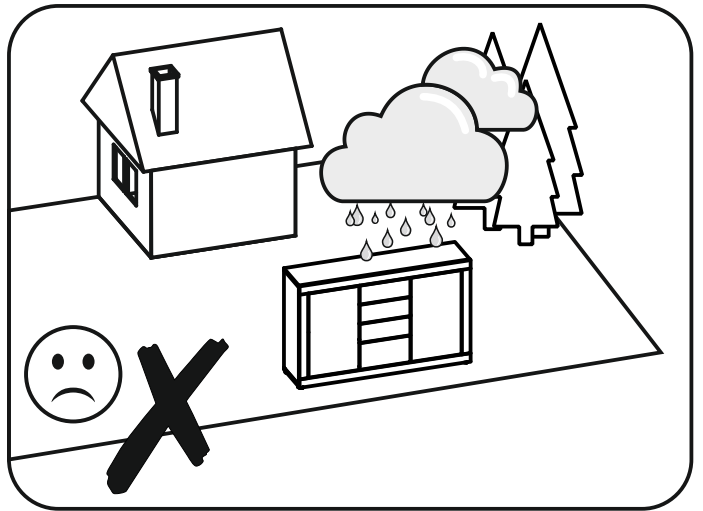
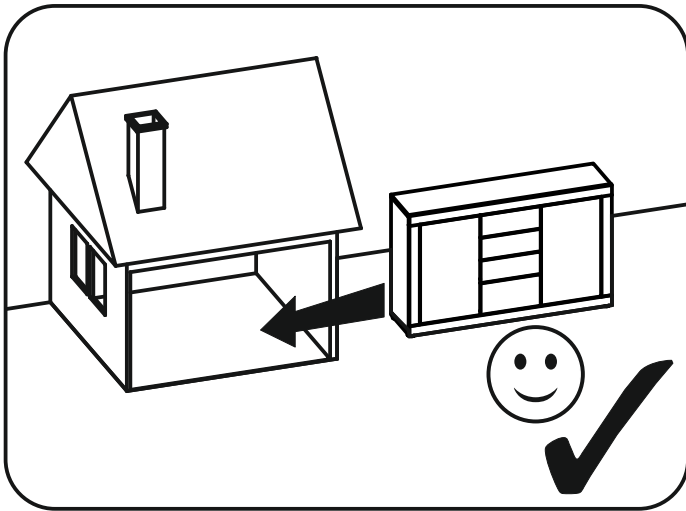
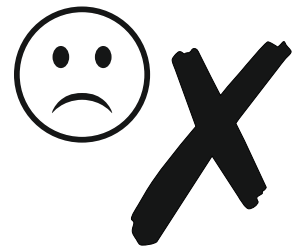

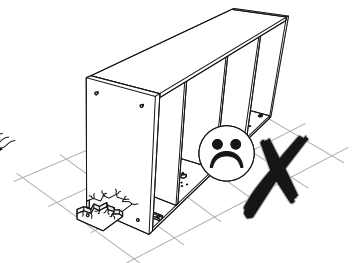
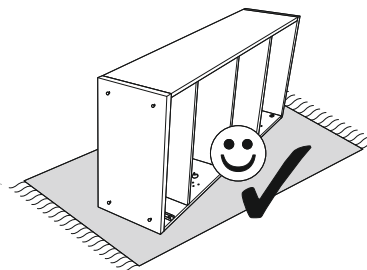
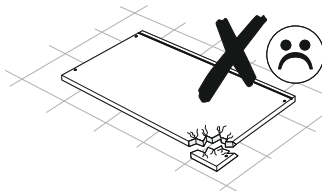
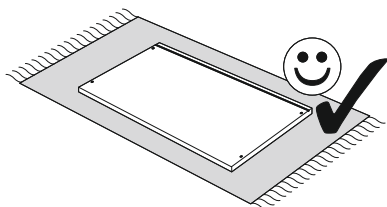
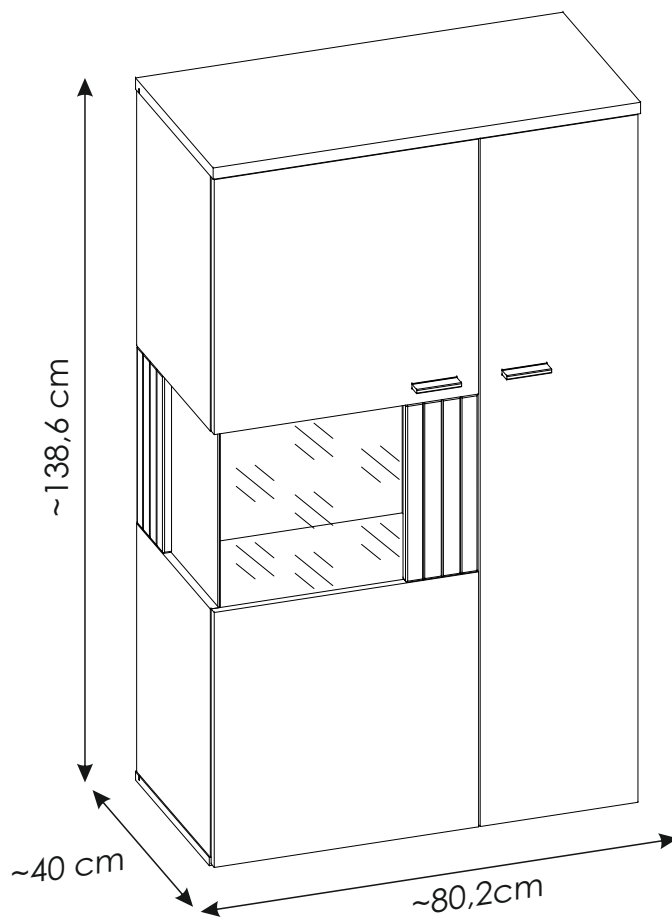
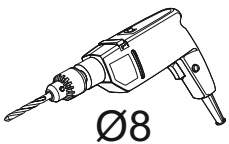
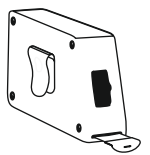
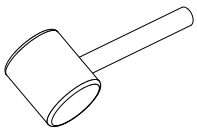
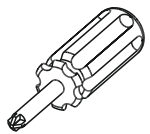
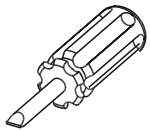
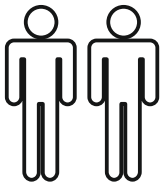

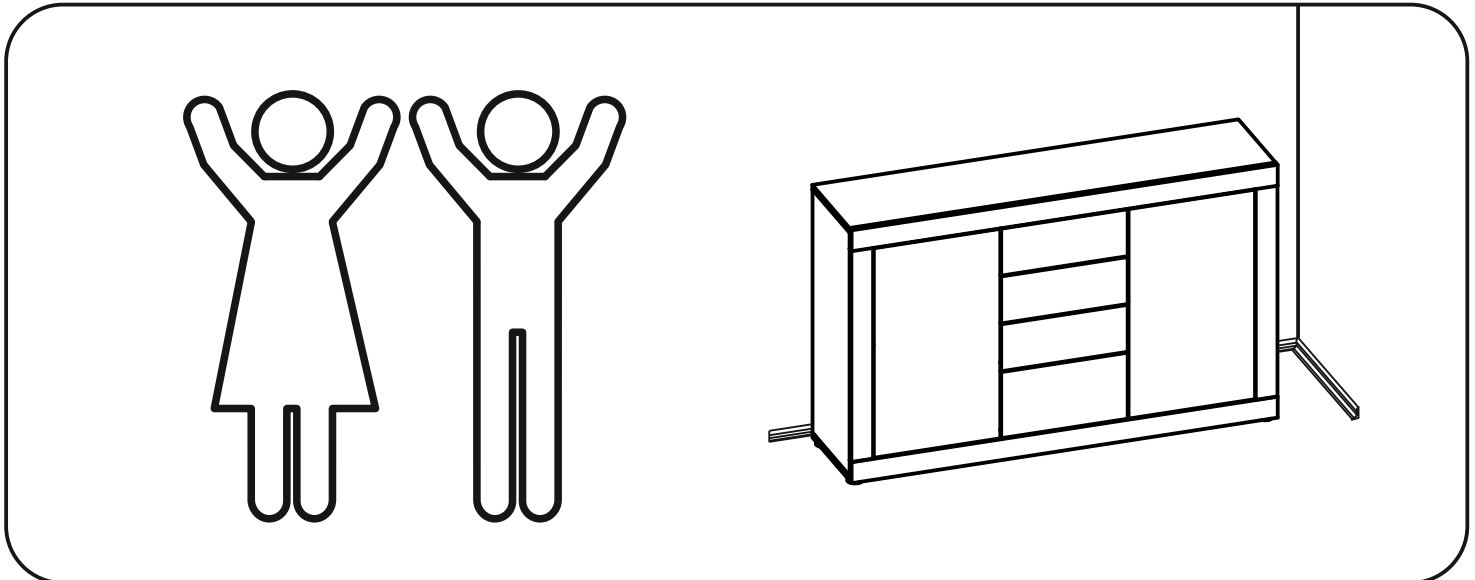
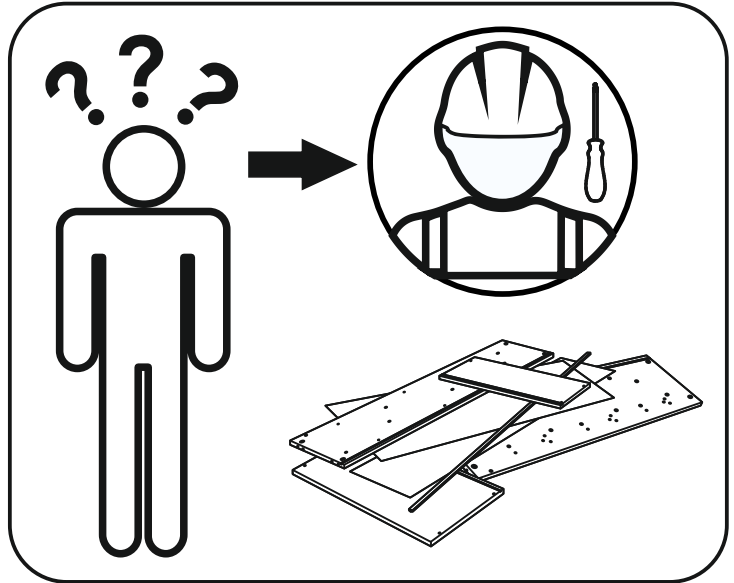
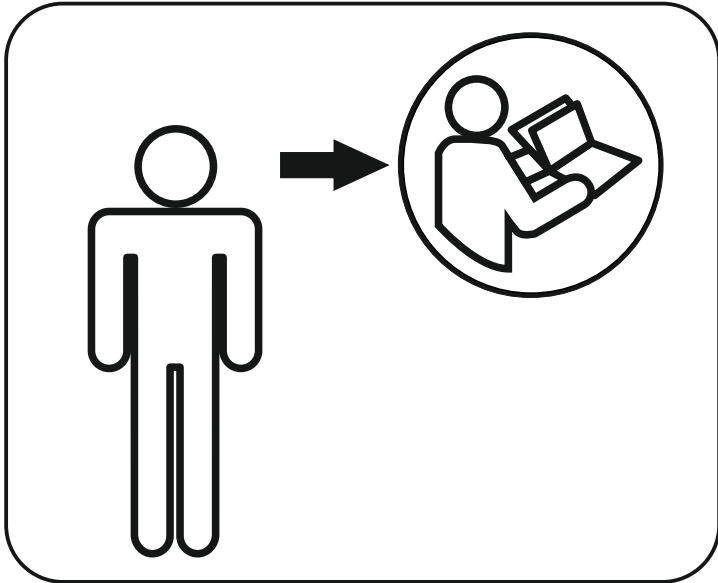
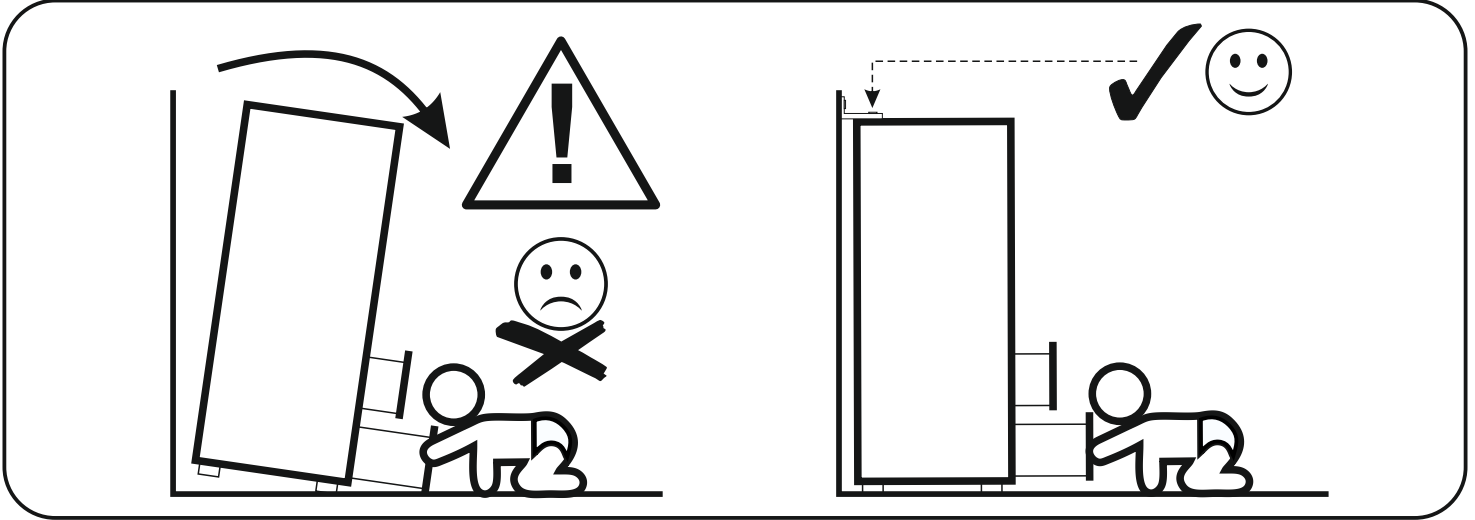
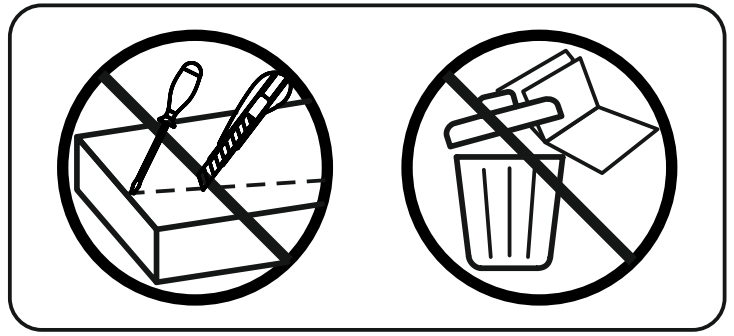
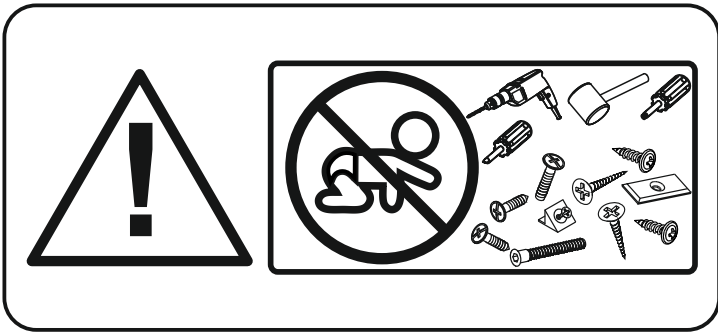

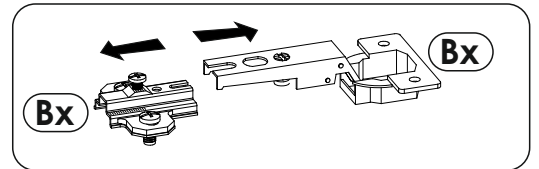
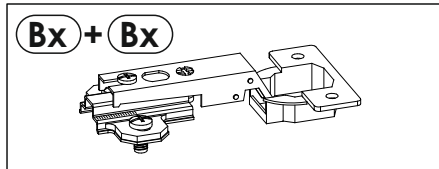
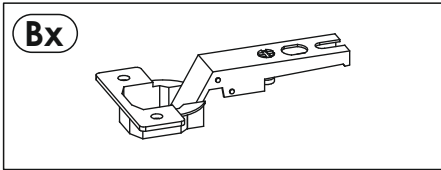
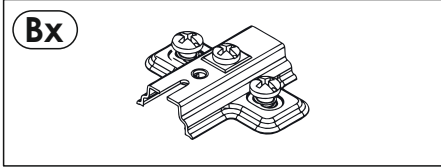

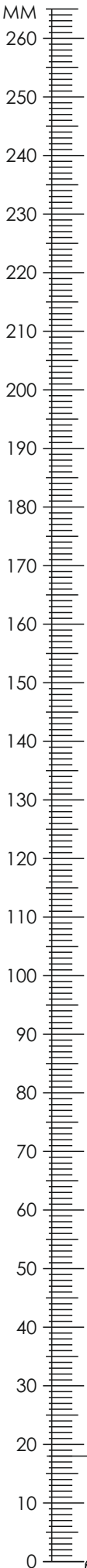



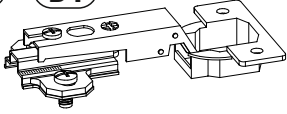

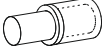
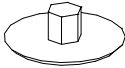

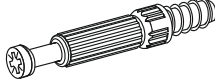
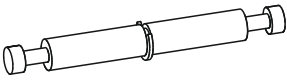
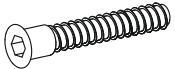

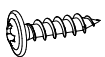

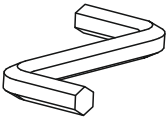

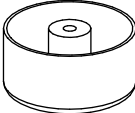
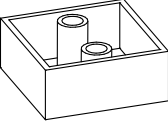

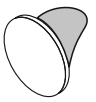
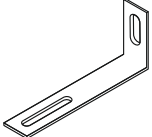
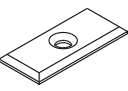
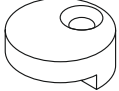
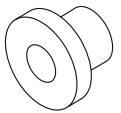
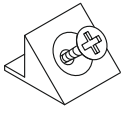
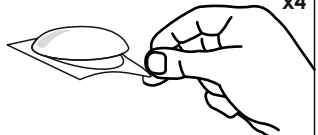
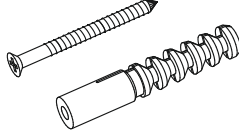
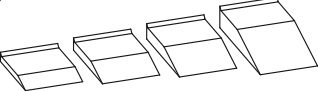
A1 8 x 35 mm x20 	A8 6 x 45 mm x8 	B0 + B1  x7
C2 5 x 13 mm x14 	D2  x24	E0 Ø16 x14 
E1 15 x 12 mm x14 	E4 12 x 10 mm x8 	F1 6 x 34 mm x14 
F3 7 x 64 mm x4 	G1 7 x 50 mm x6 	H1  x2 L - 84 mm
I2 4 x 16 mm x10 	I4 3,5 x 27 mm x8 	I5 3,5 x 27 mm x4 
M  x1	N1 3 x 16 mm x20 	O1  x1
O4  x4	P15  x1	P16  x8
Q9  x2	R1  x14	R2  x4
R3  x8	R4  x10	R8  x4
S13  x2 Ø8	Z  x1	

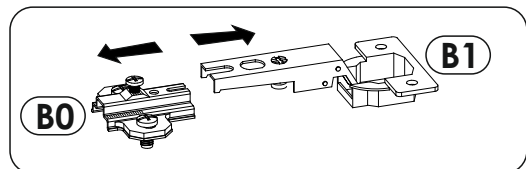

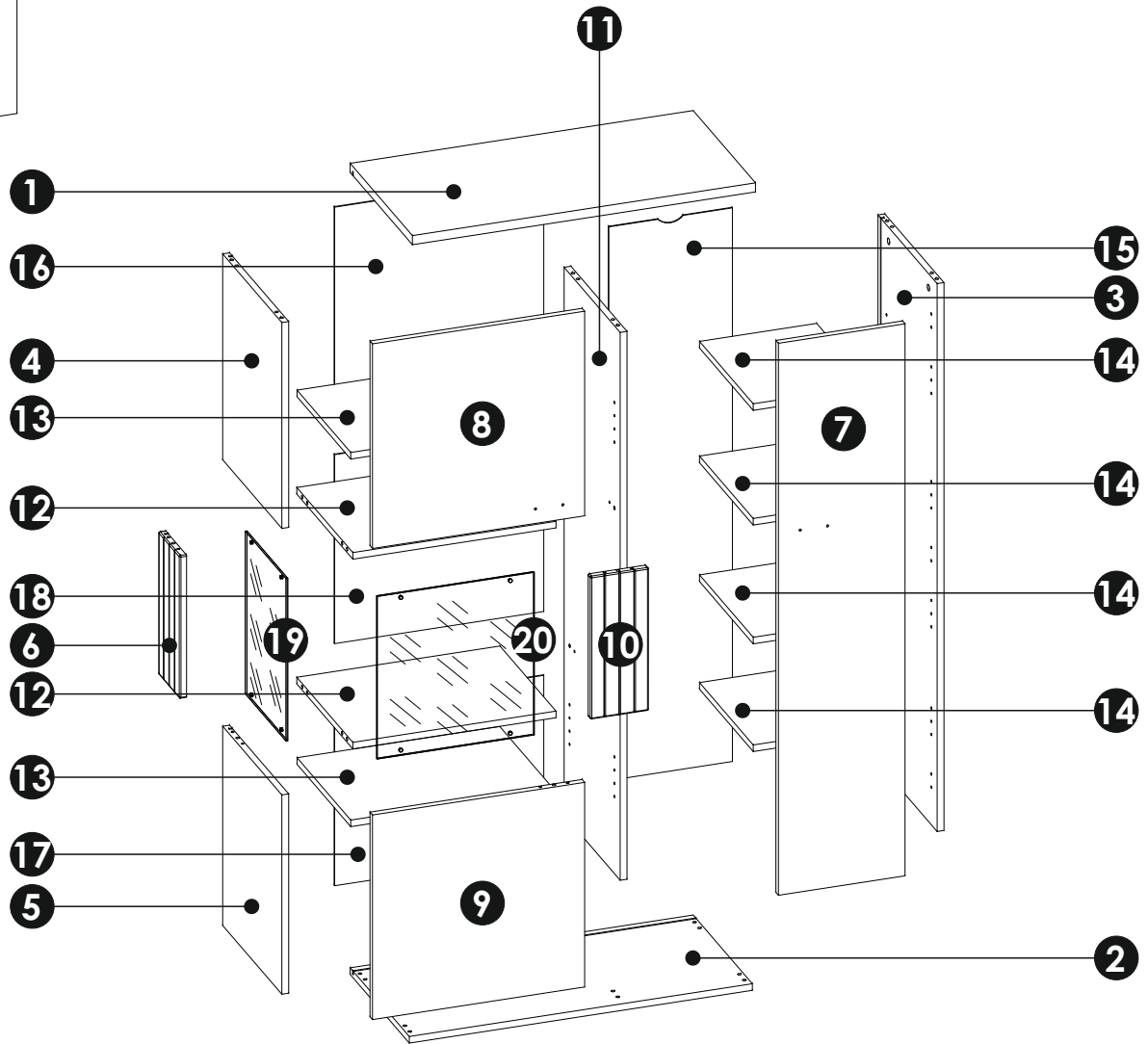
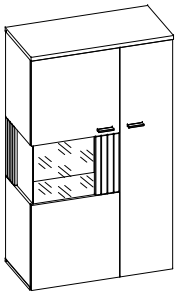

1	802	400	22	x1	1/2
2	800	380	16	x1	2/2
3	1328	380	16	x1	2/2
4	499	380	16	x1	2/2
5	483	380	16	x1	2/2
6	346	136	16	x1	2/2
7	1338	296	16	x1	2/2

8	496	496	16	x1	1/2
9	496	496	16	x1	1/2
10	346	136	16	x1	2/2
11	1328	360	16	x1	2/2
12	475	360	16	x2	1/2
13	474	345	16	x2	1/2
14	274	345	16	x4	1/2

15	1342	289	3	x1	2/2
16	448	489	3	x1	1/2
17	432	489	3	x1	1/2
18	458	489	3	x1	1/2
19	394	262	4	x1	2/2
20	394	367	4	x1	2/2

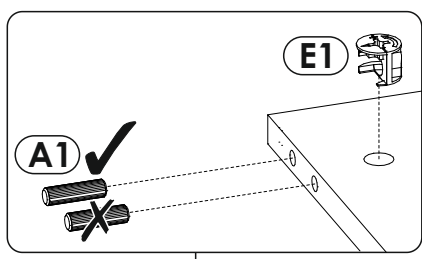
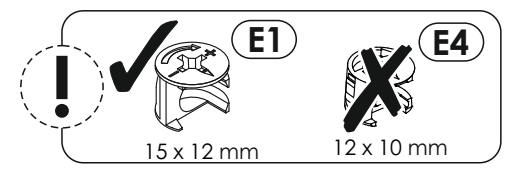
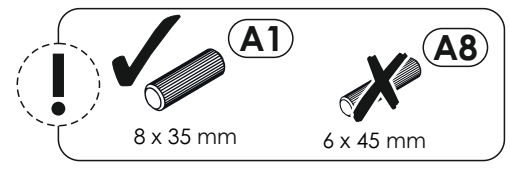
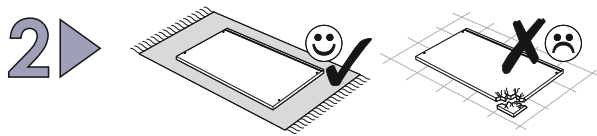
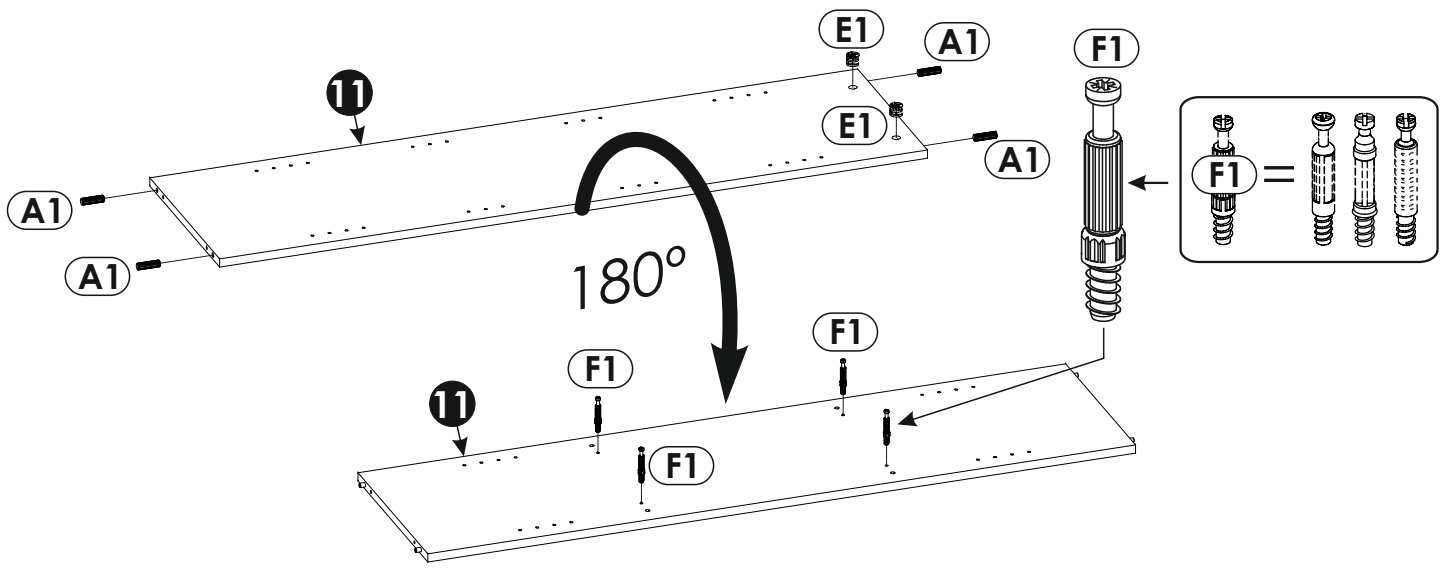
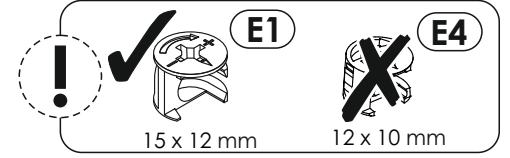
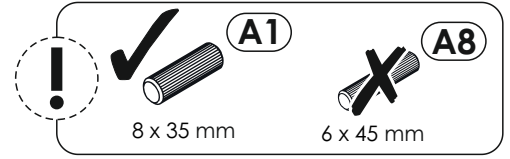
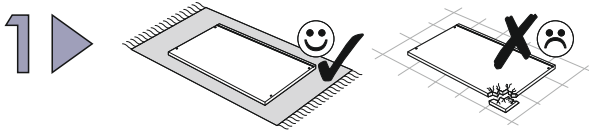
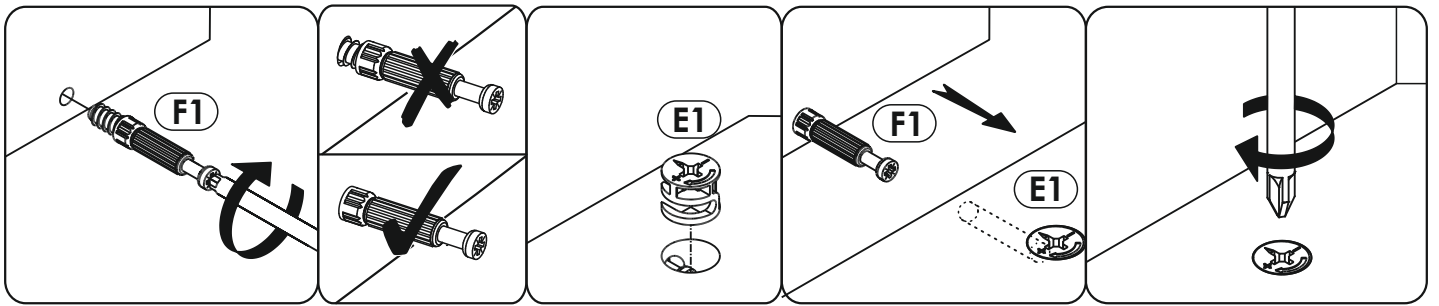

x2

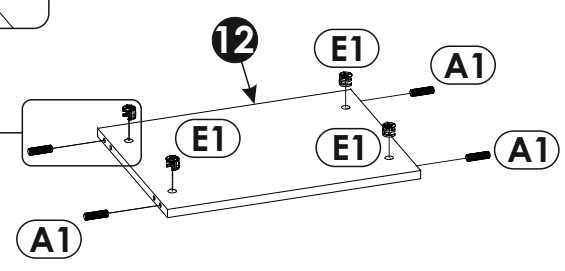

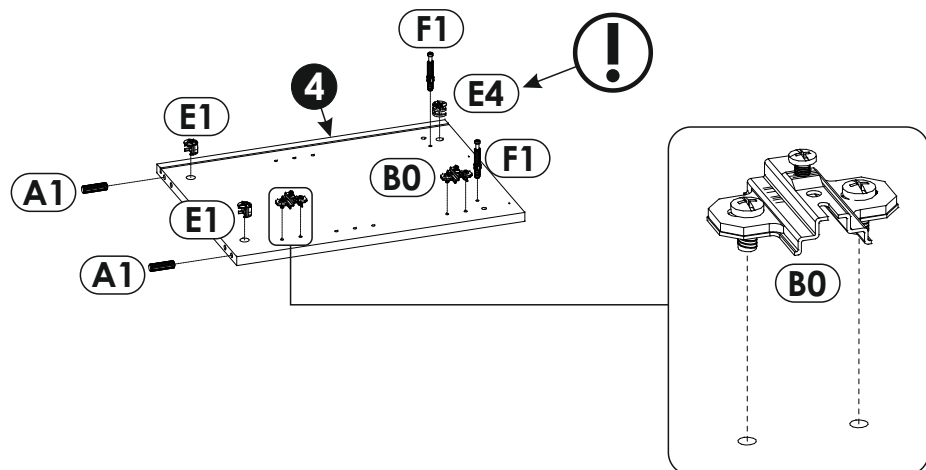
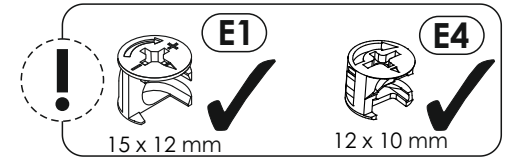
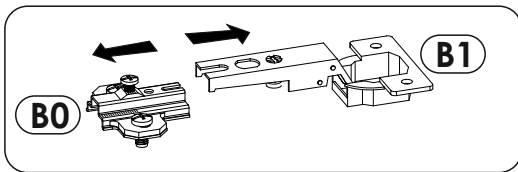
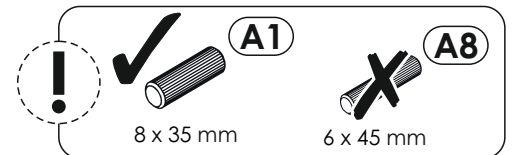
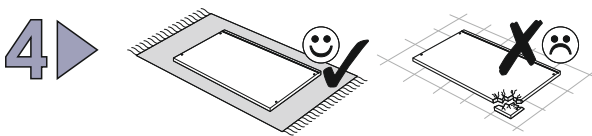
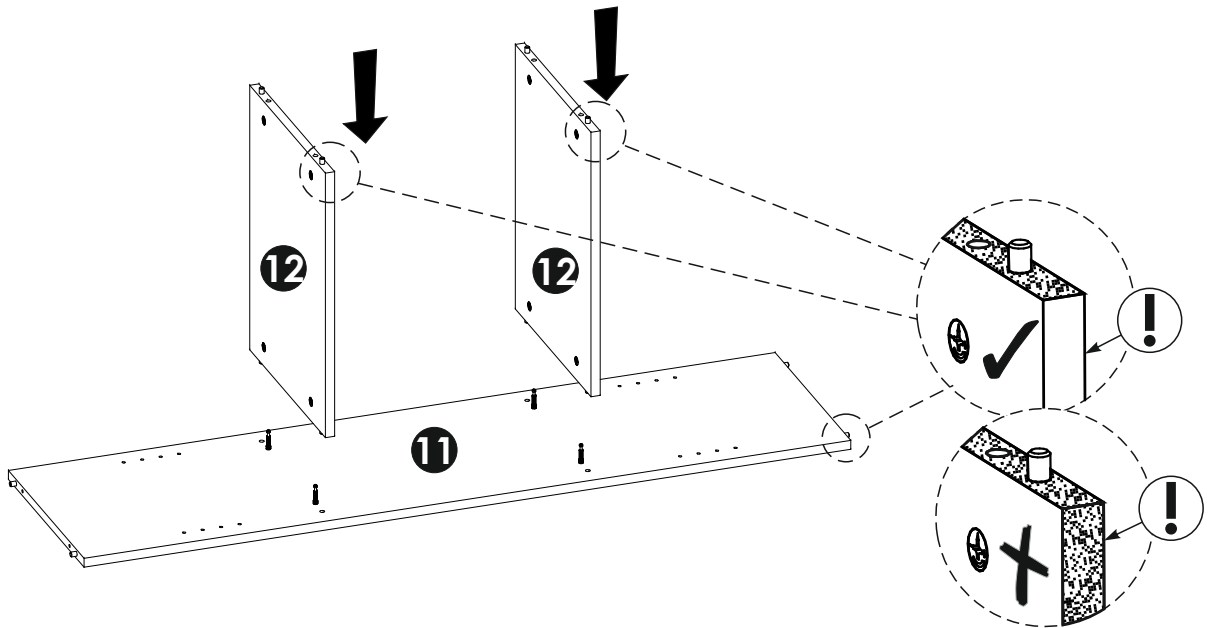
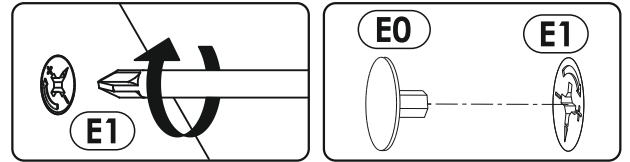
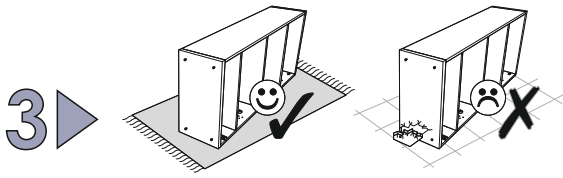

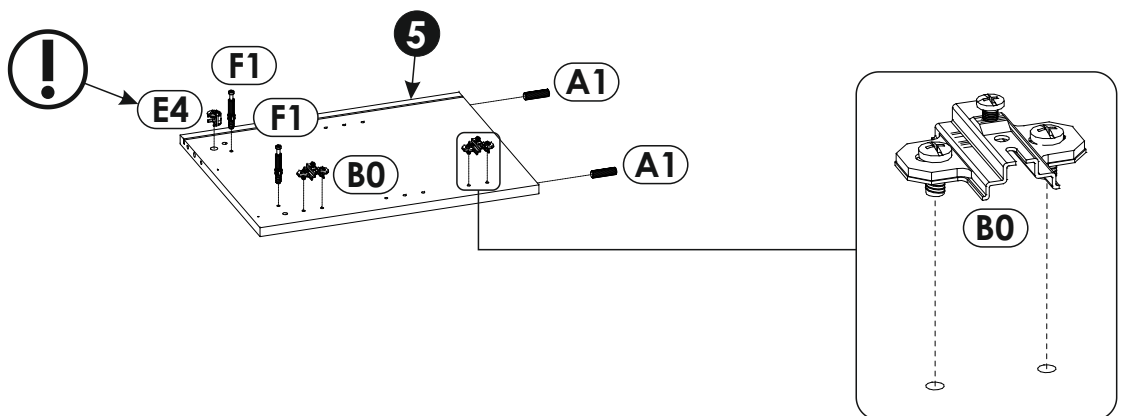
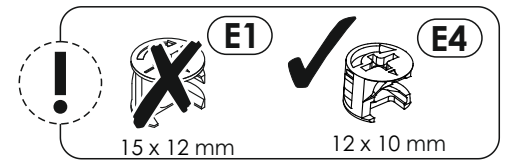
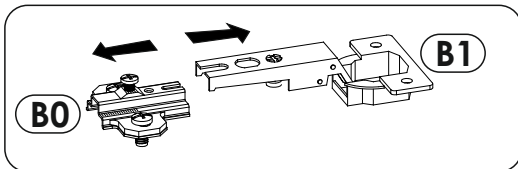
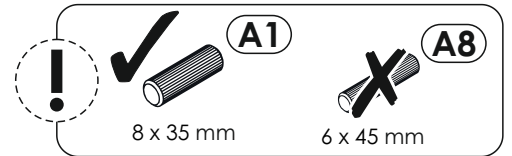
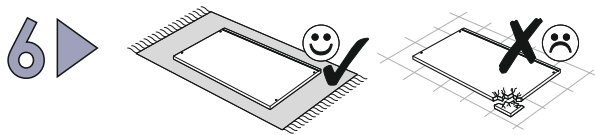
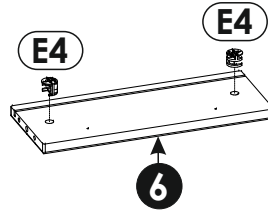
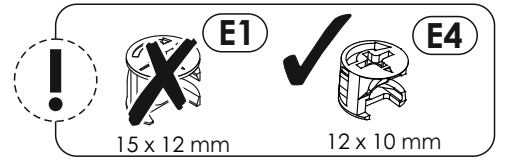
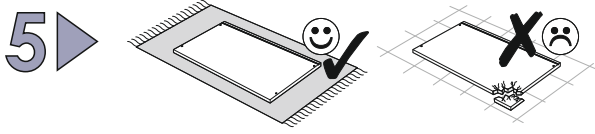

7 ▶

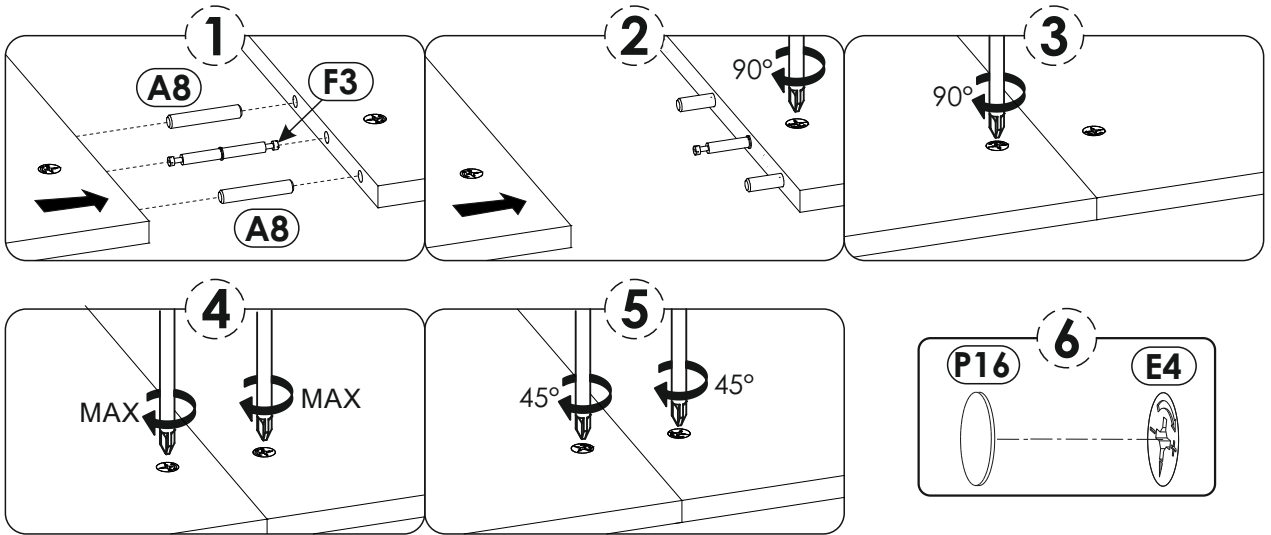
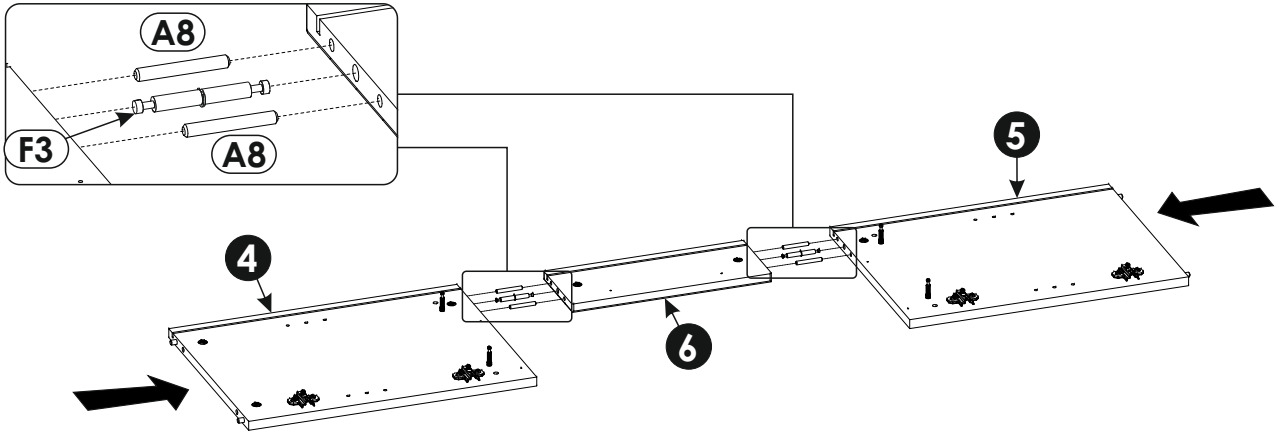
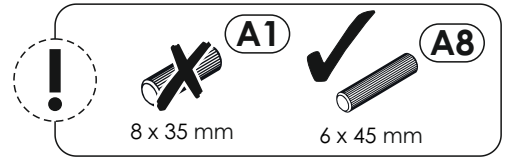
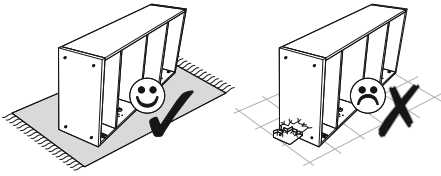

8 ▶

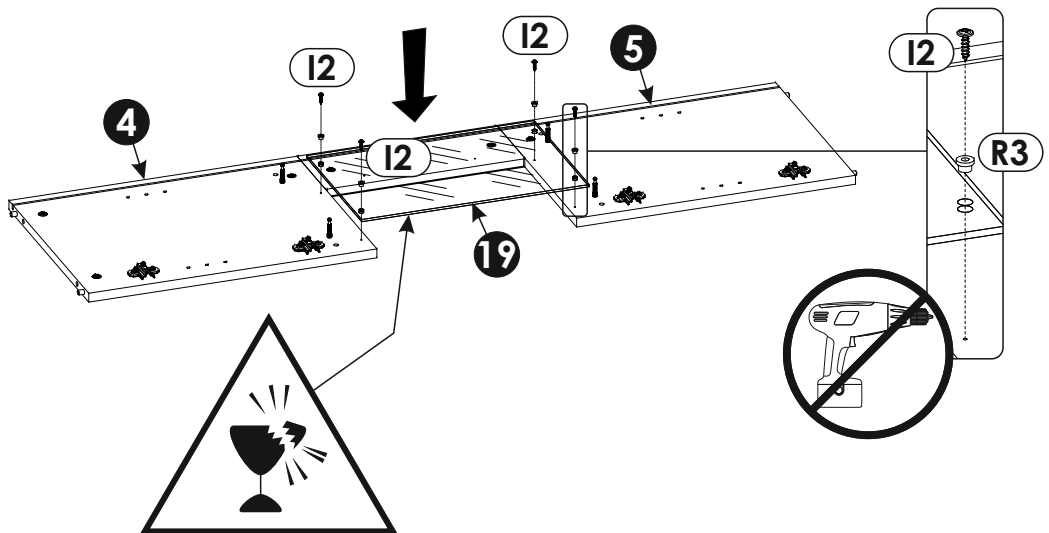
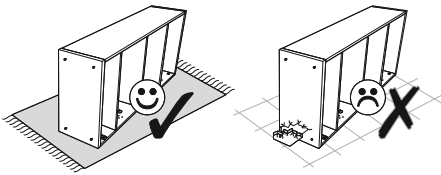

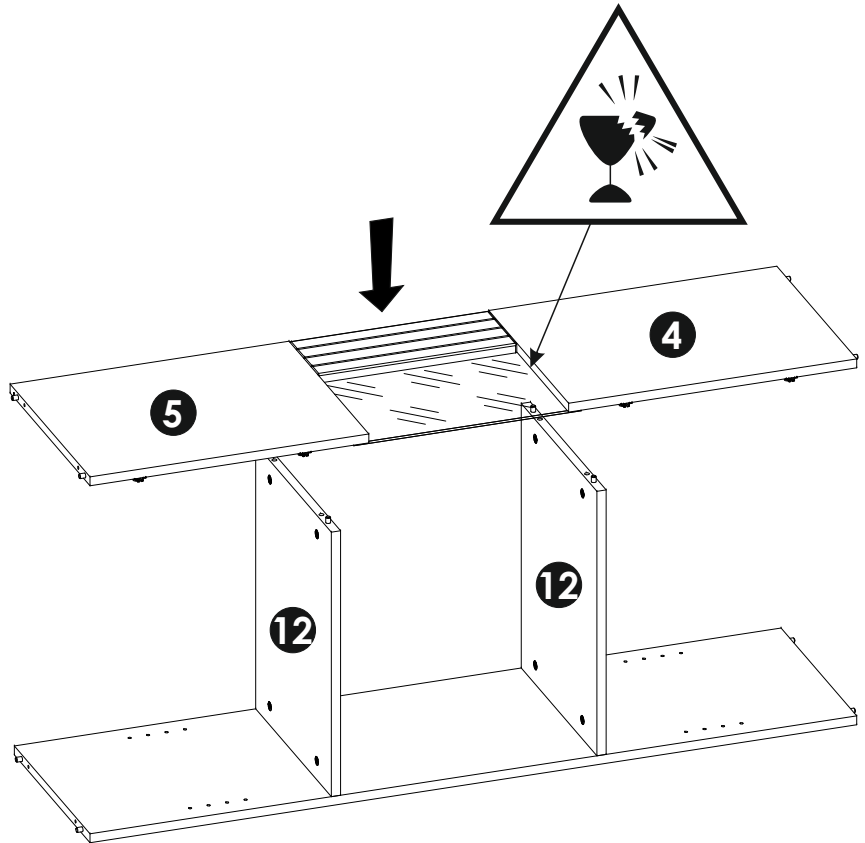
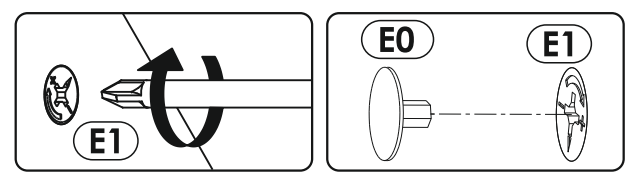
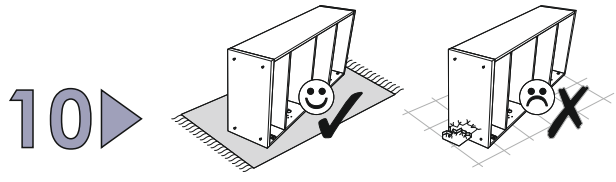
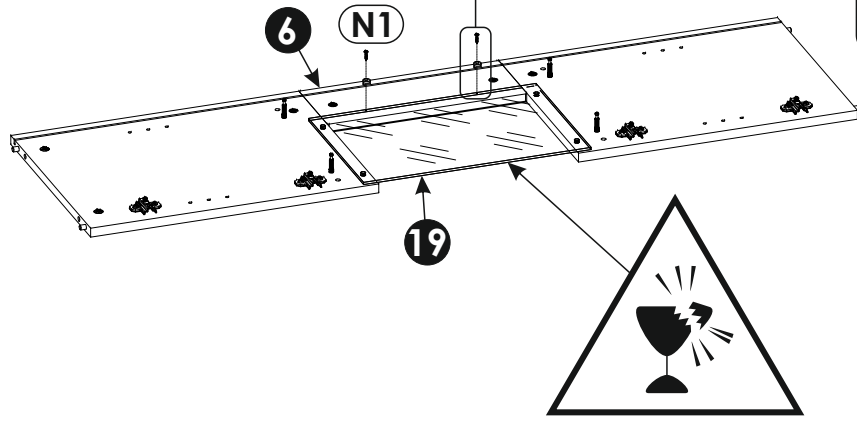
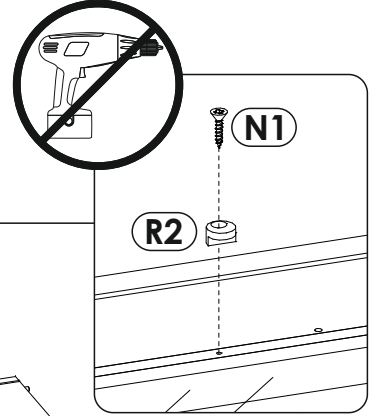
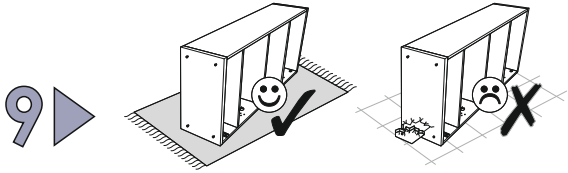

11 ▶

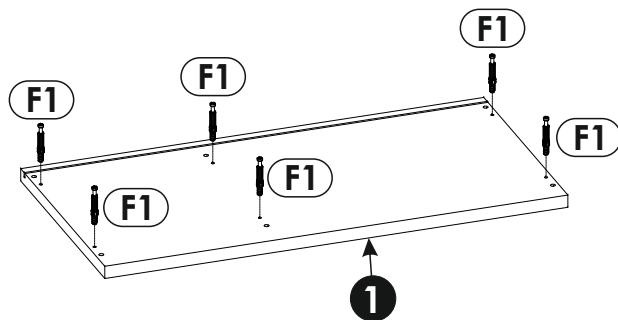
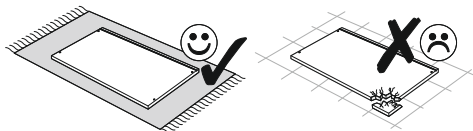

12 ▶

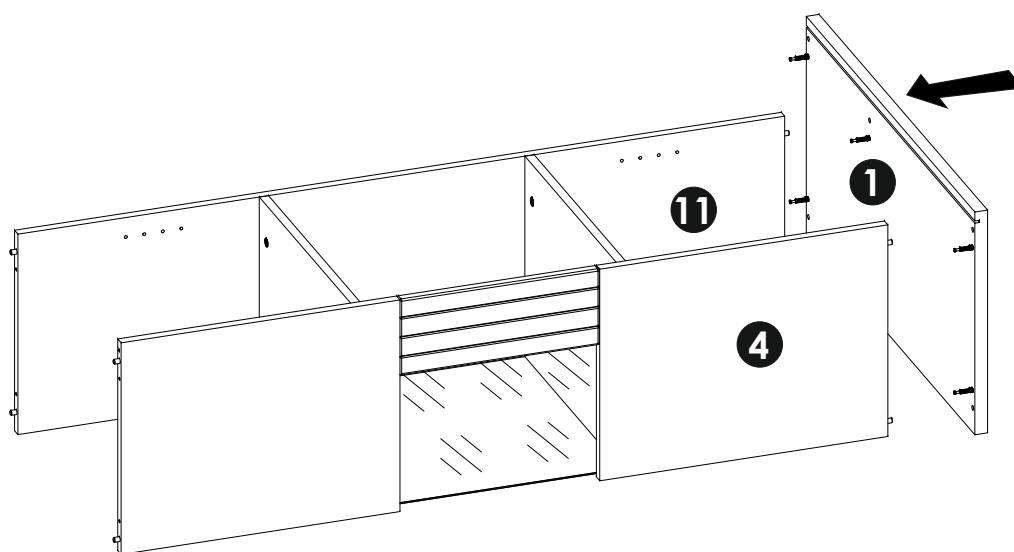
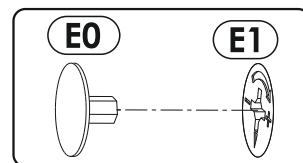
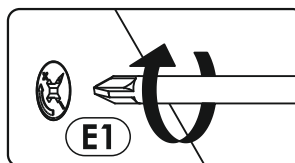
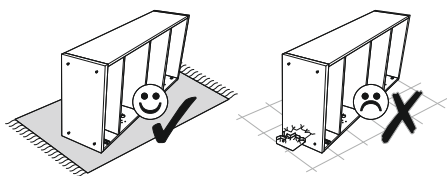

13▶

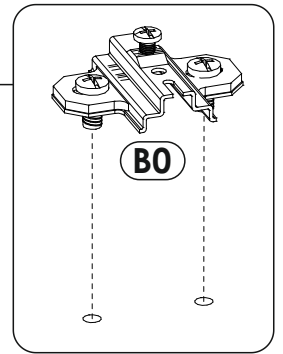
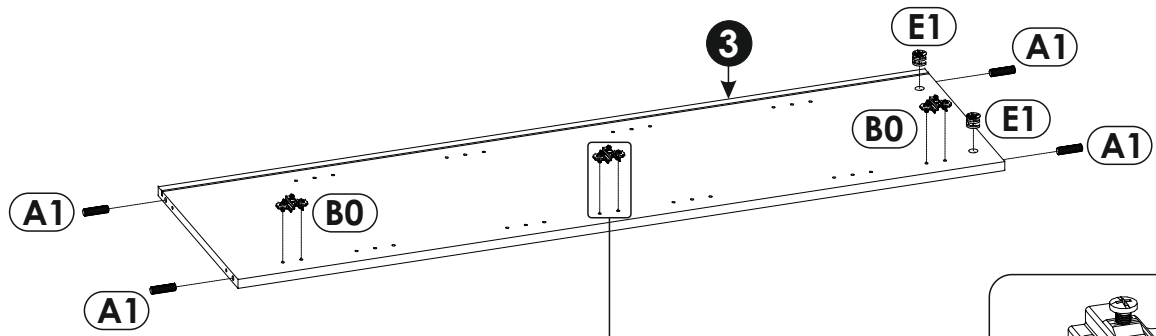
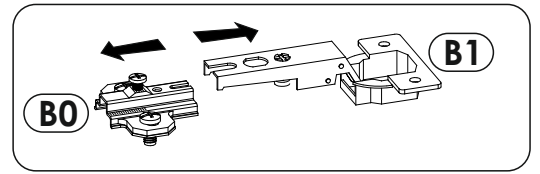
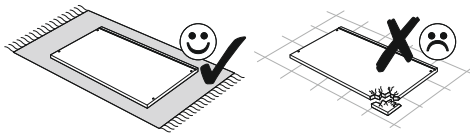

14▶

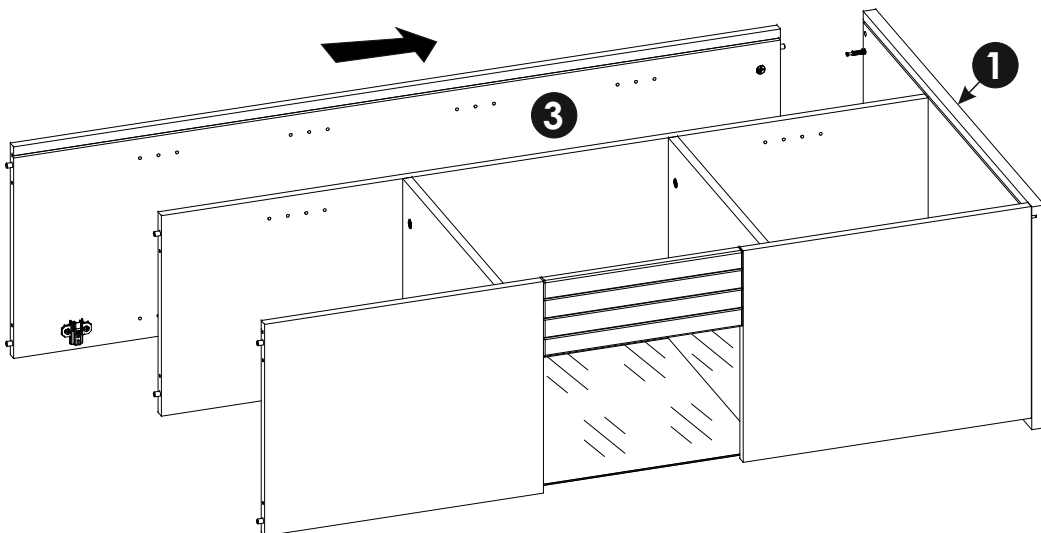
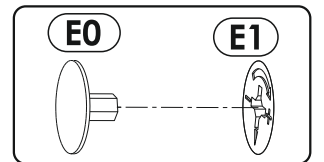
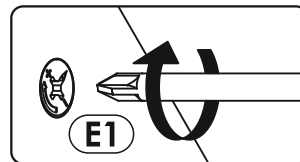
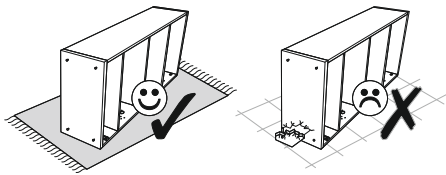

15▶

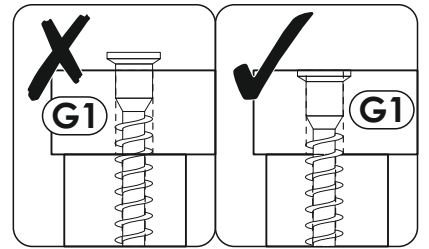
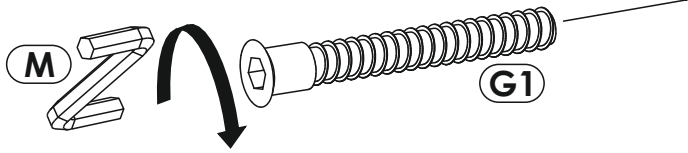
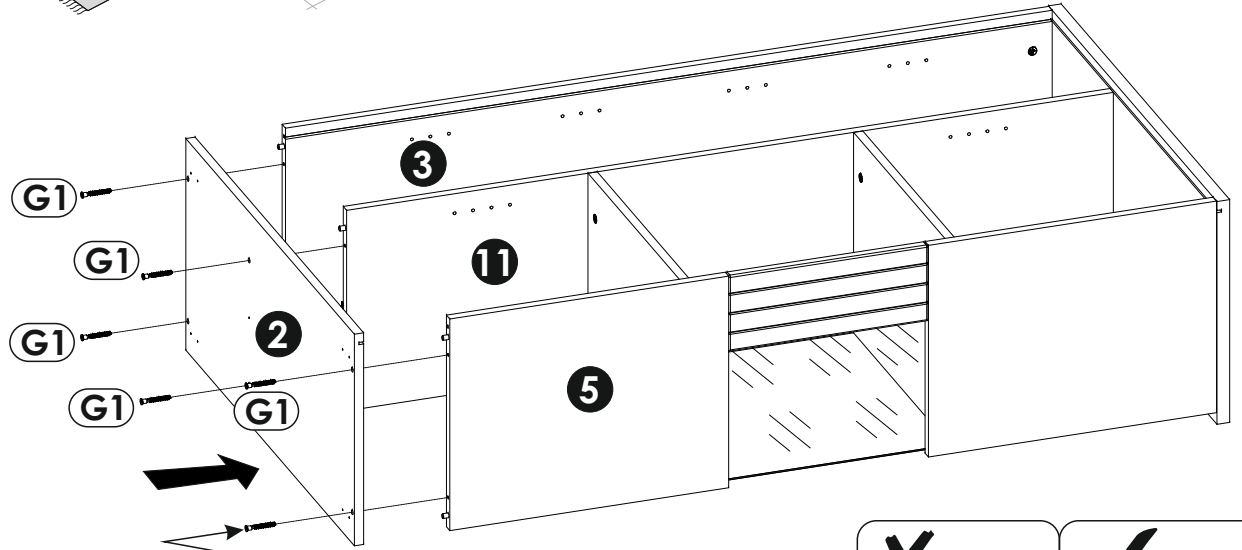
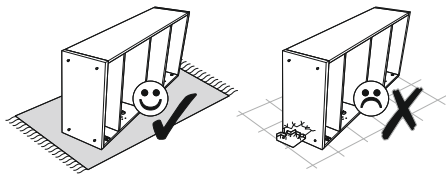

16▶

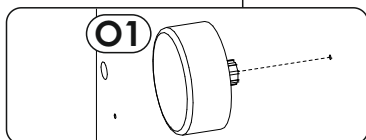
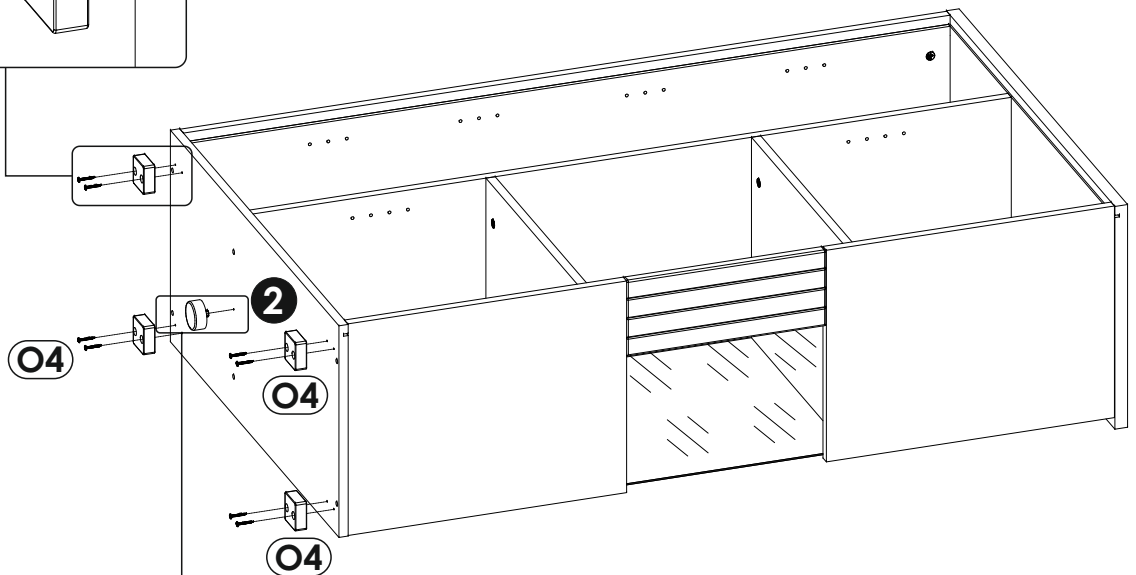
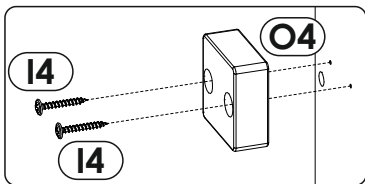
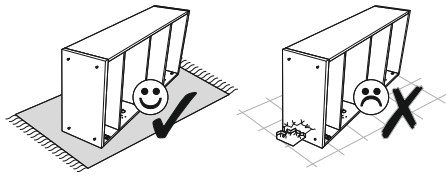

17 ▶

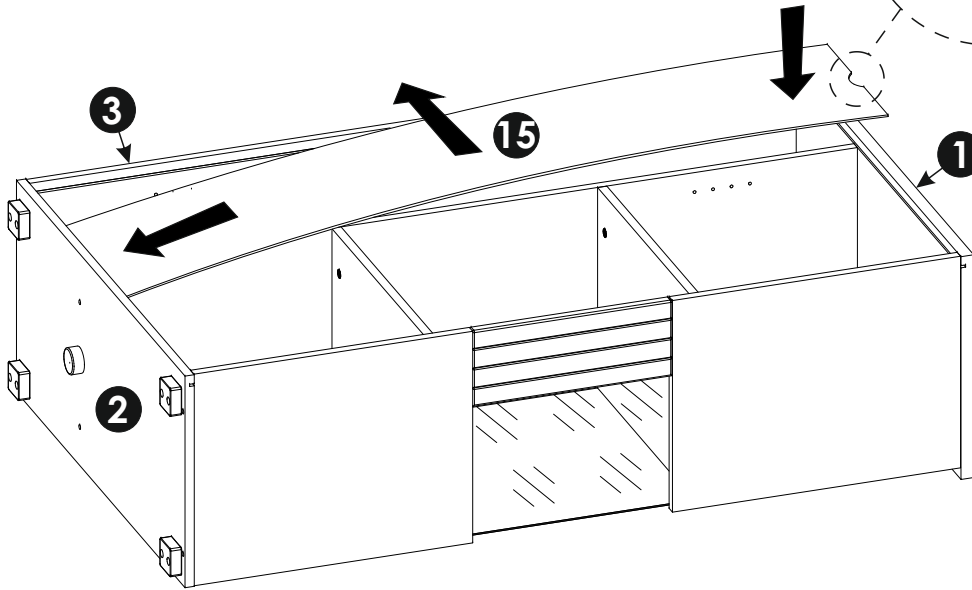
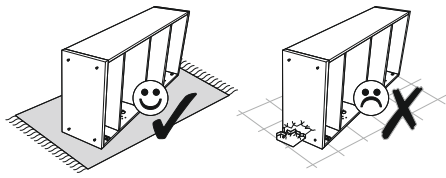

18 ▶

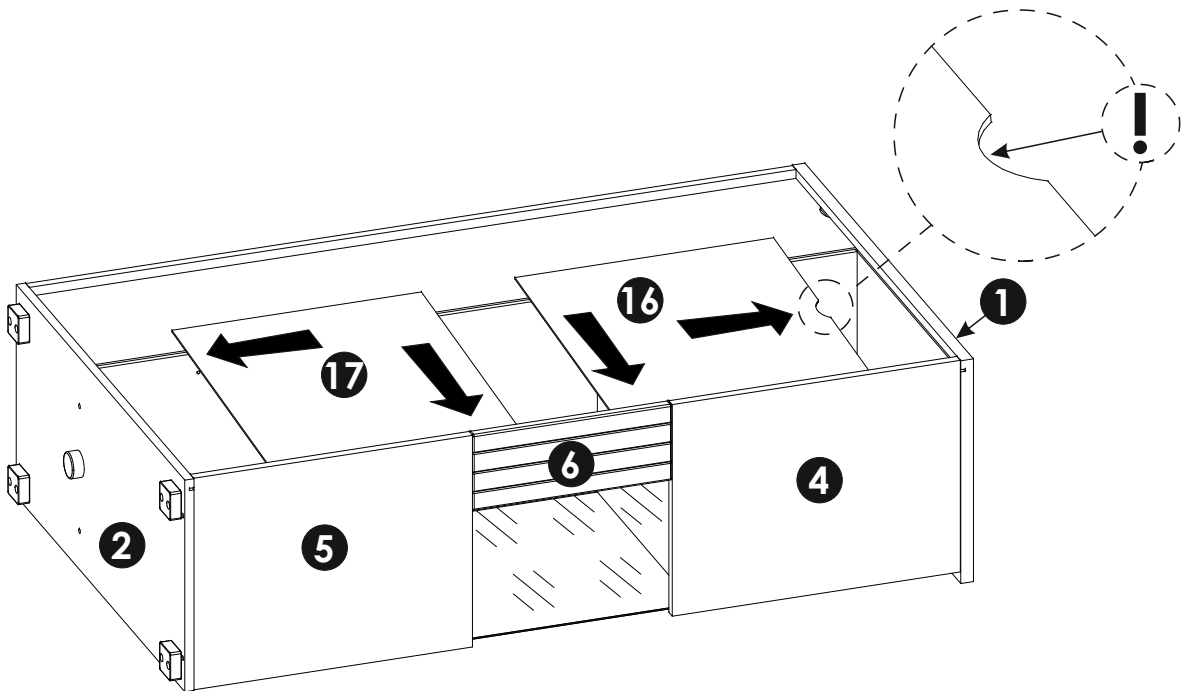
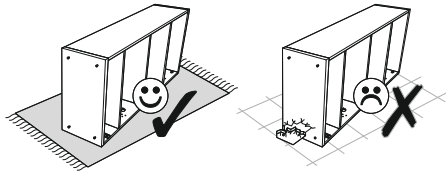

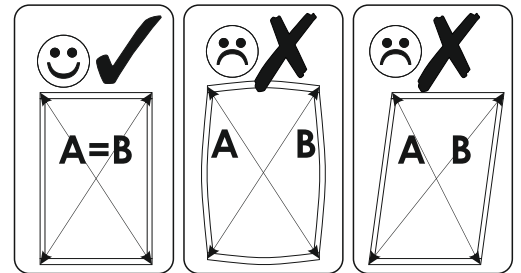
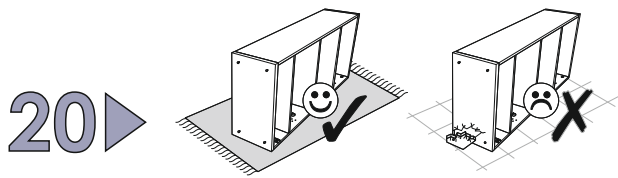
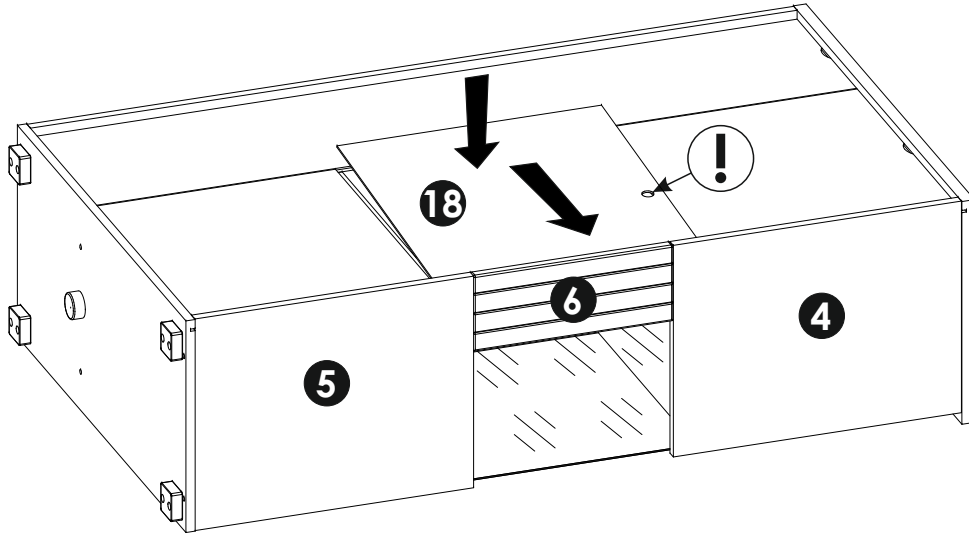
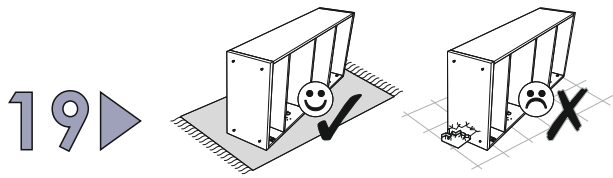

A=B

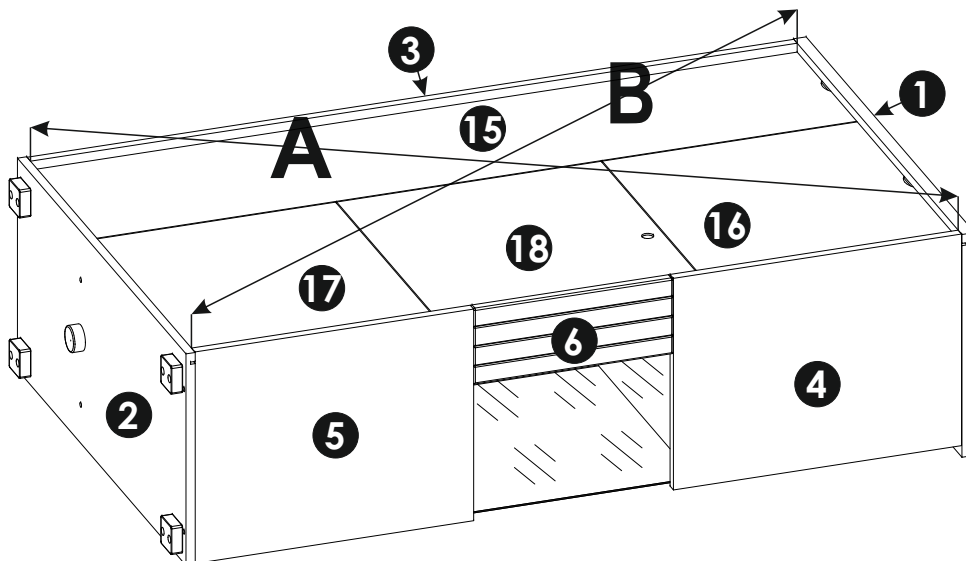

21 ▶

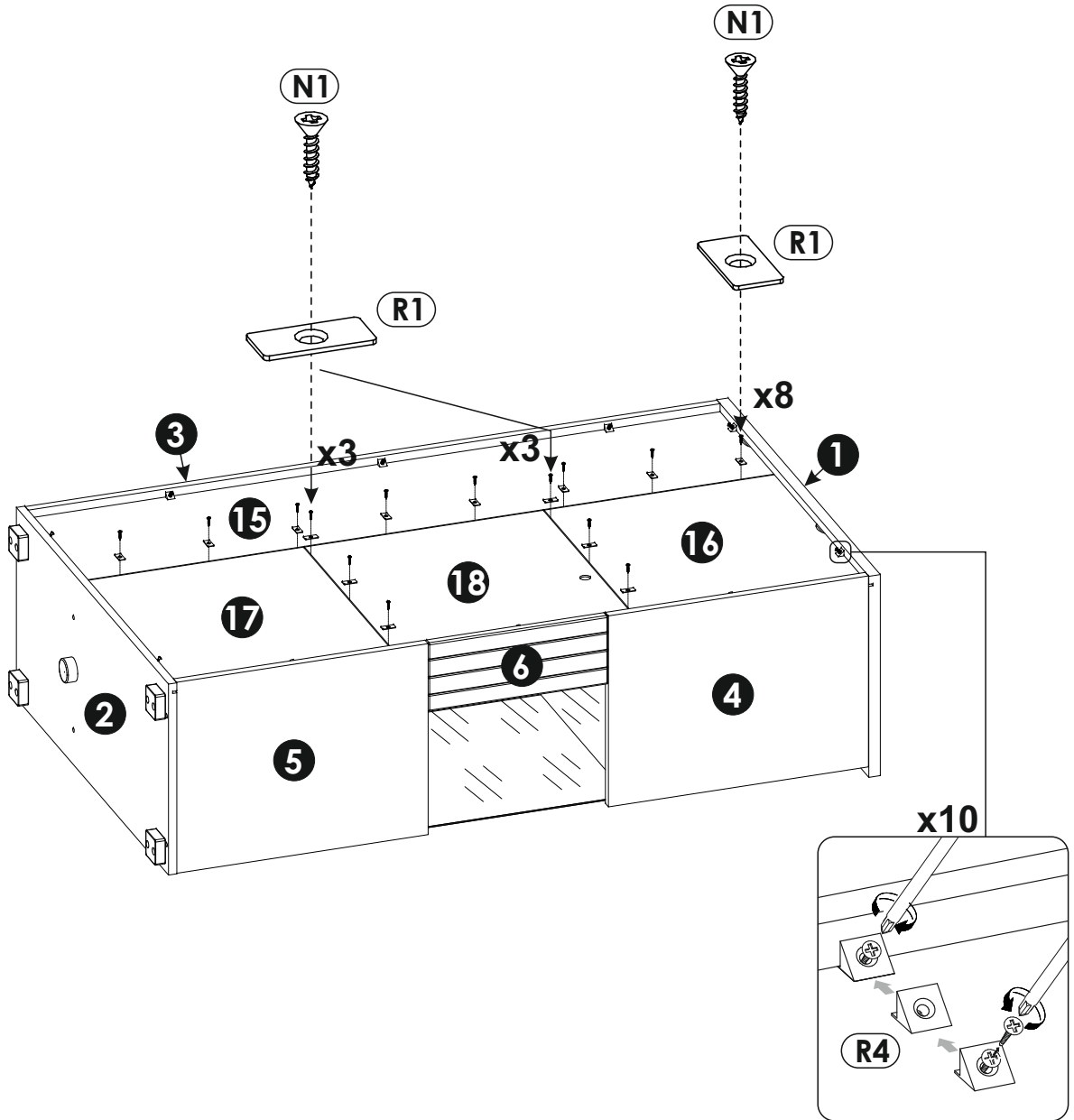
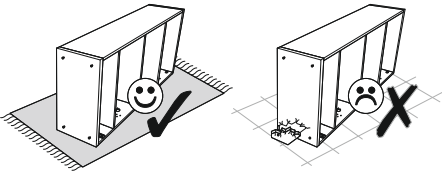

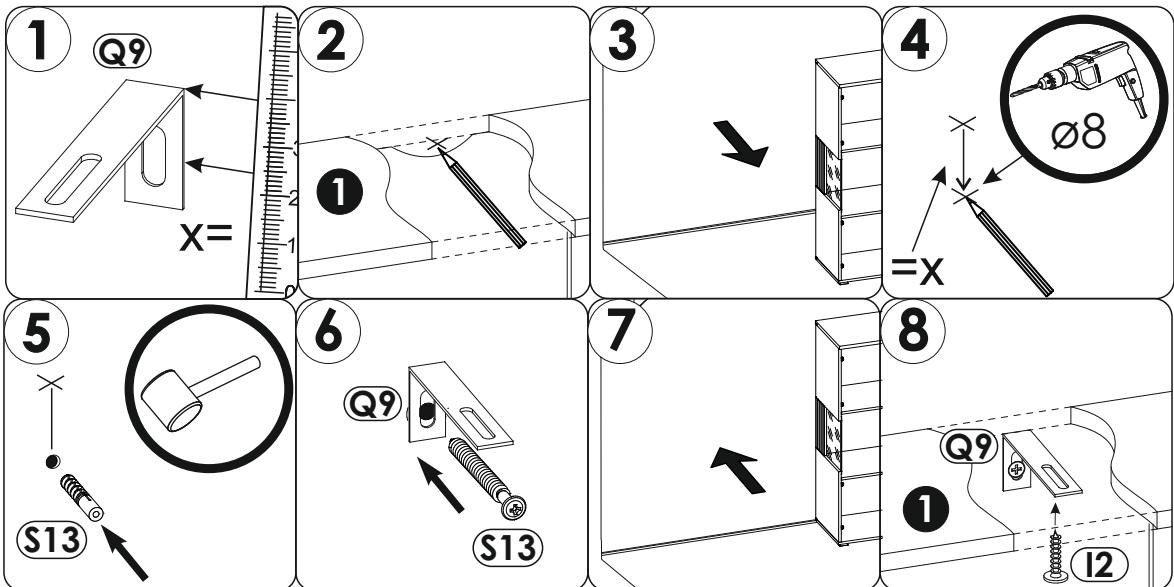
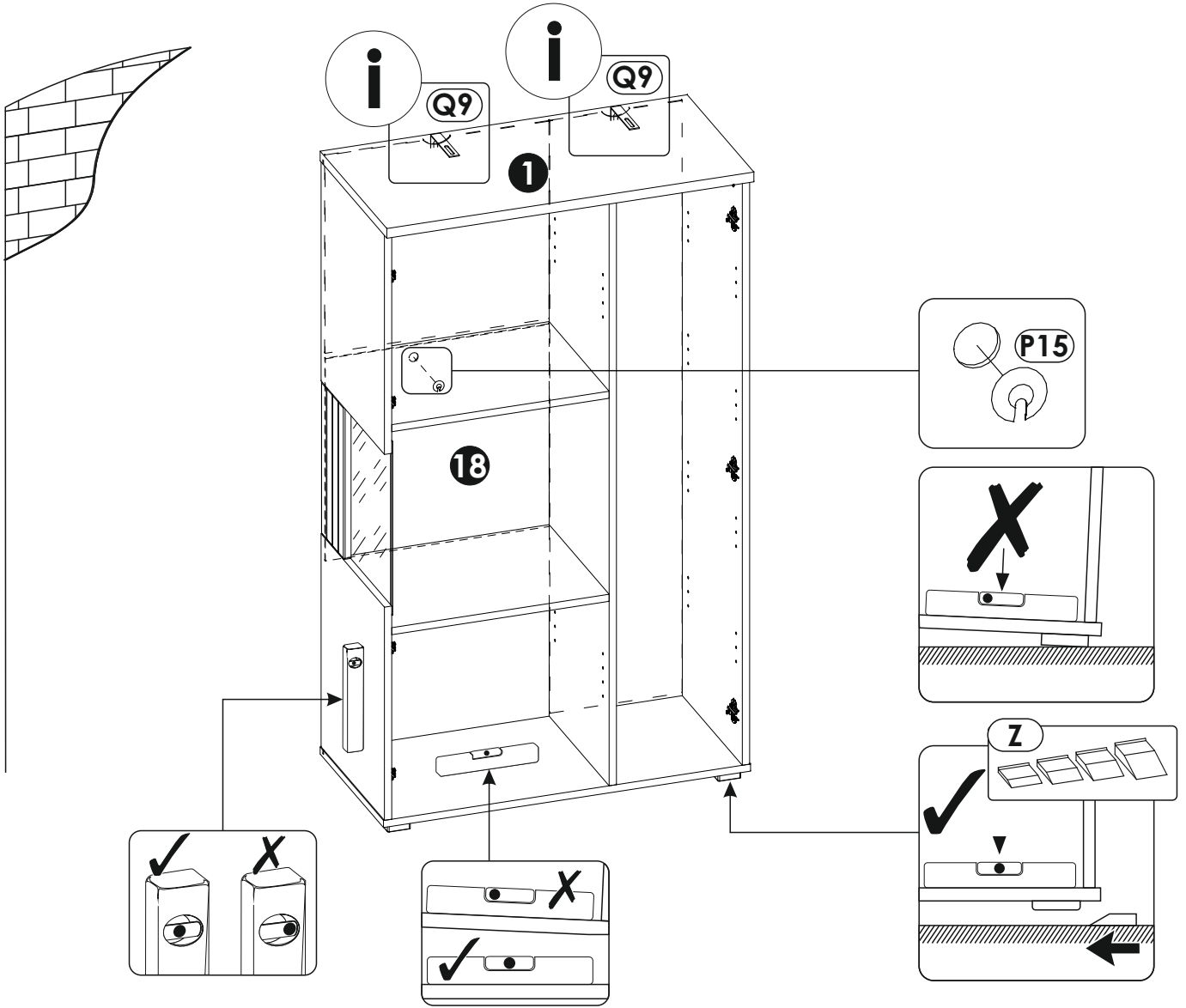
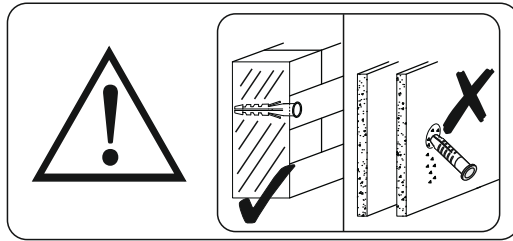

23 ▶

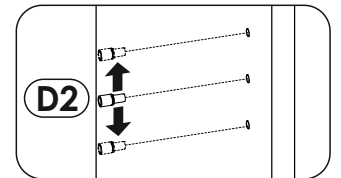
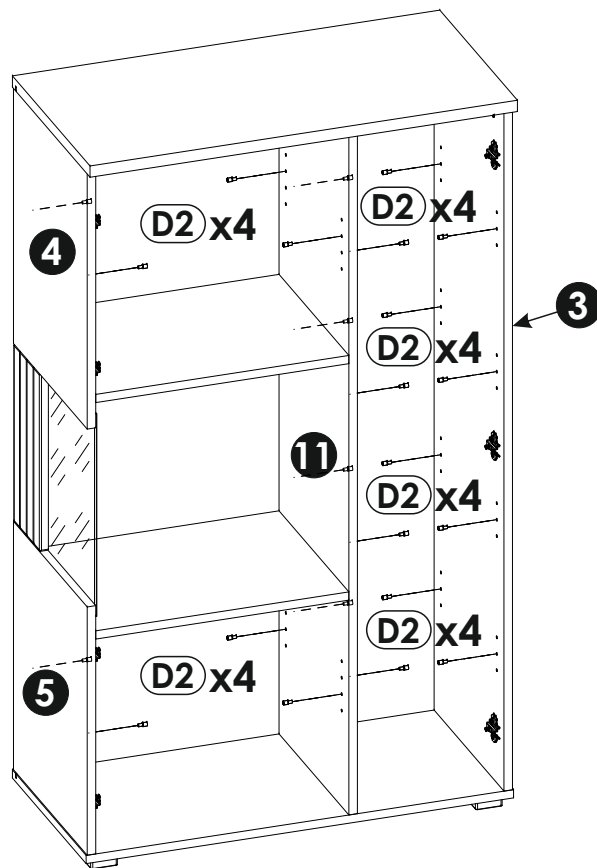

24 ▶

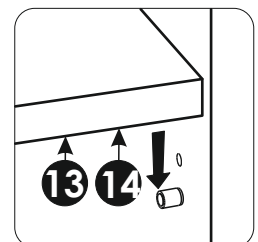
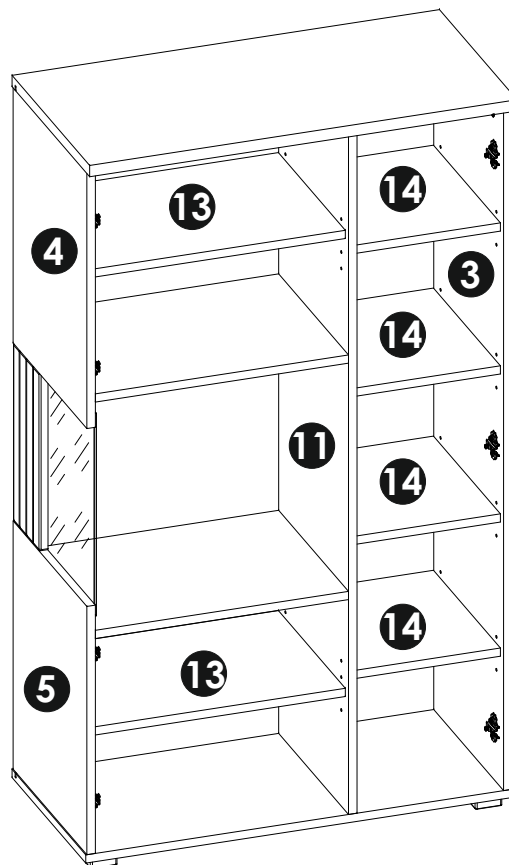

25 ▶

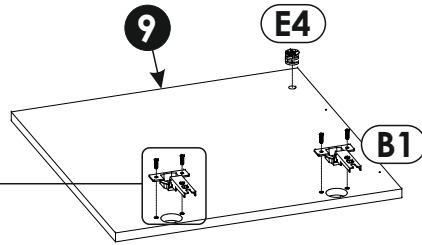
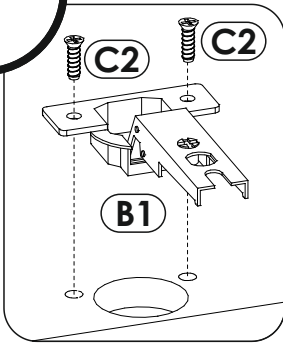
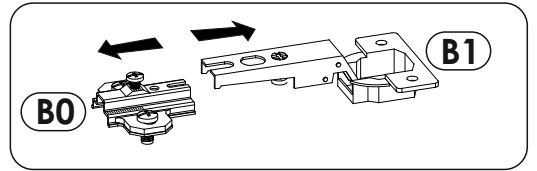
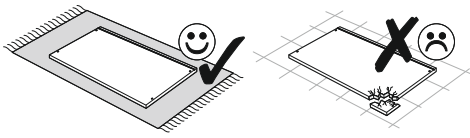

26 ▶

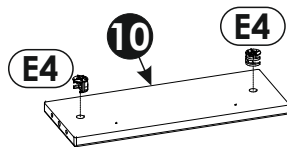
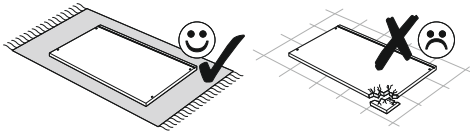

27 ▶

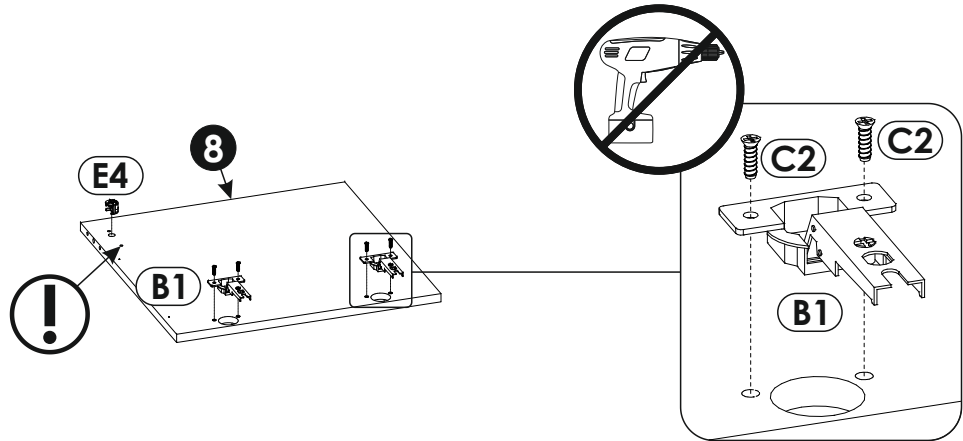
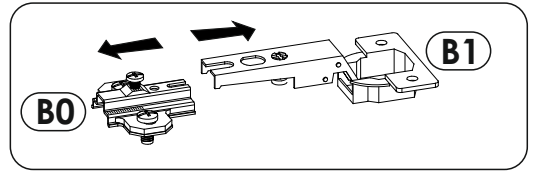
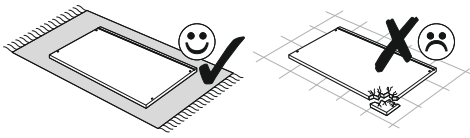

28 ▶

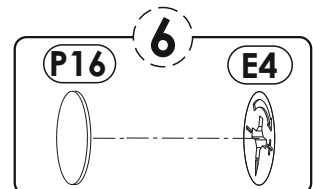
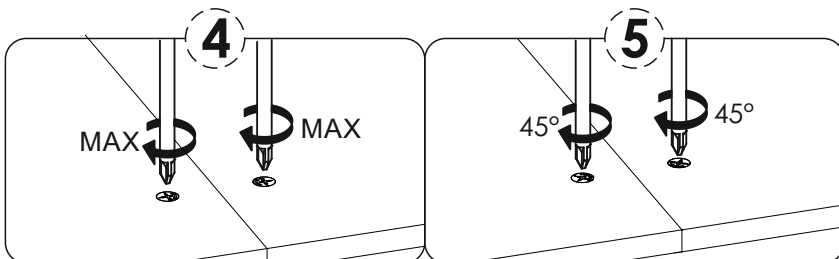
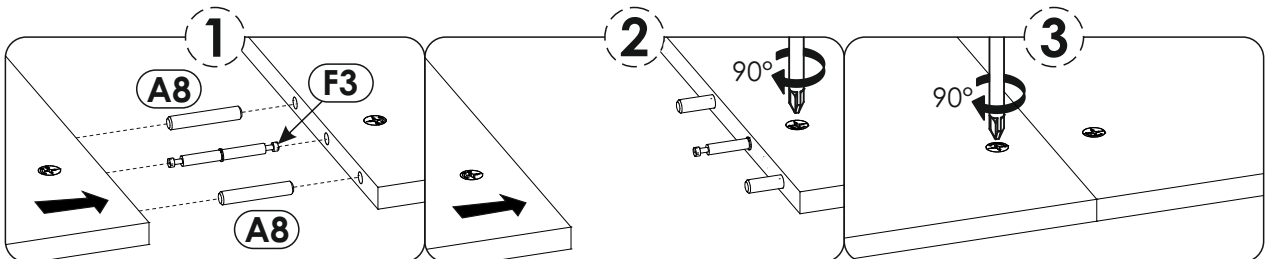
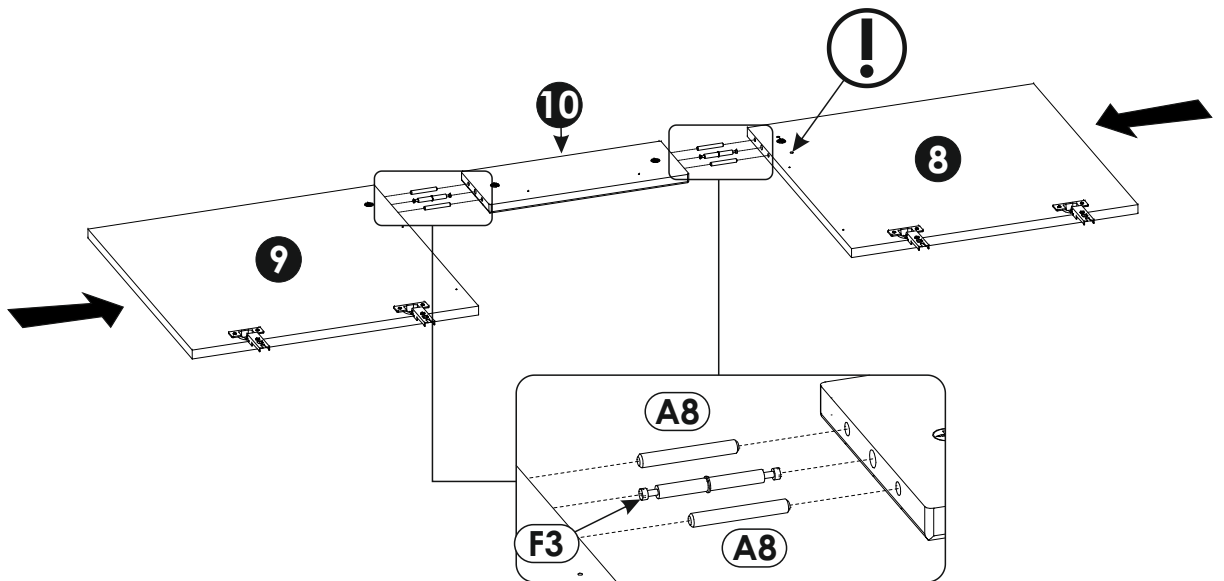
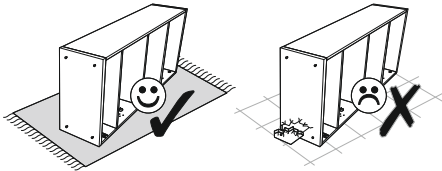

29 ▶

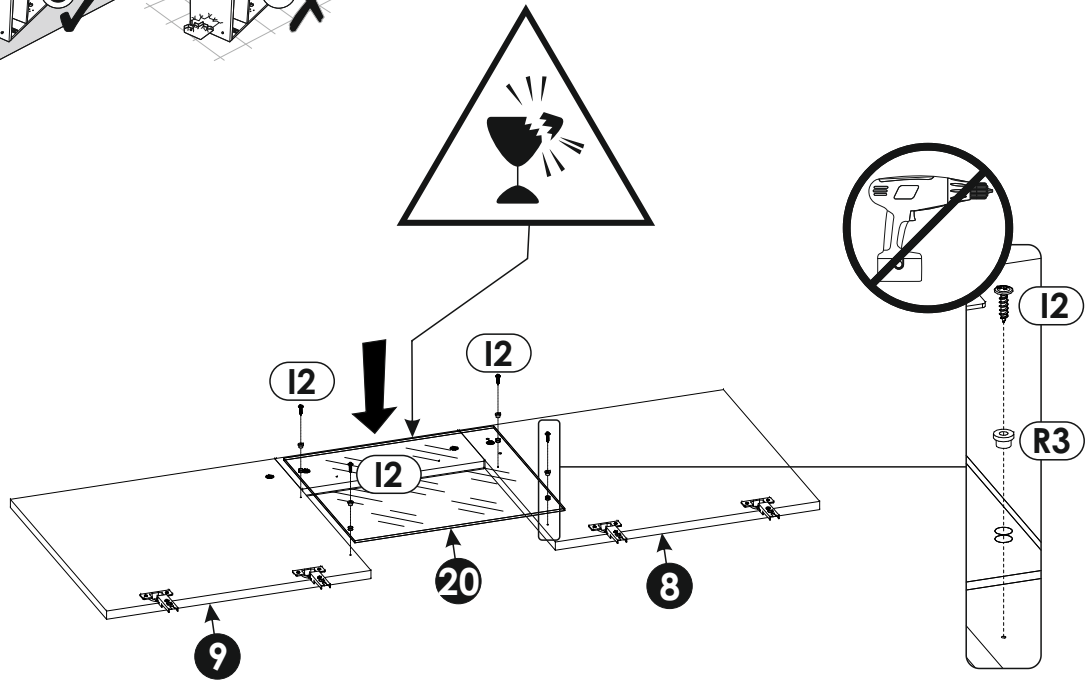
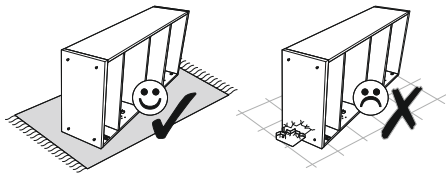

30 ▶

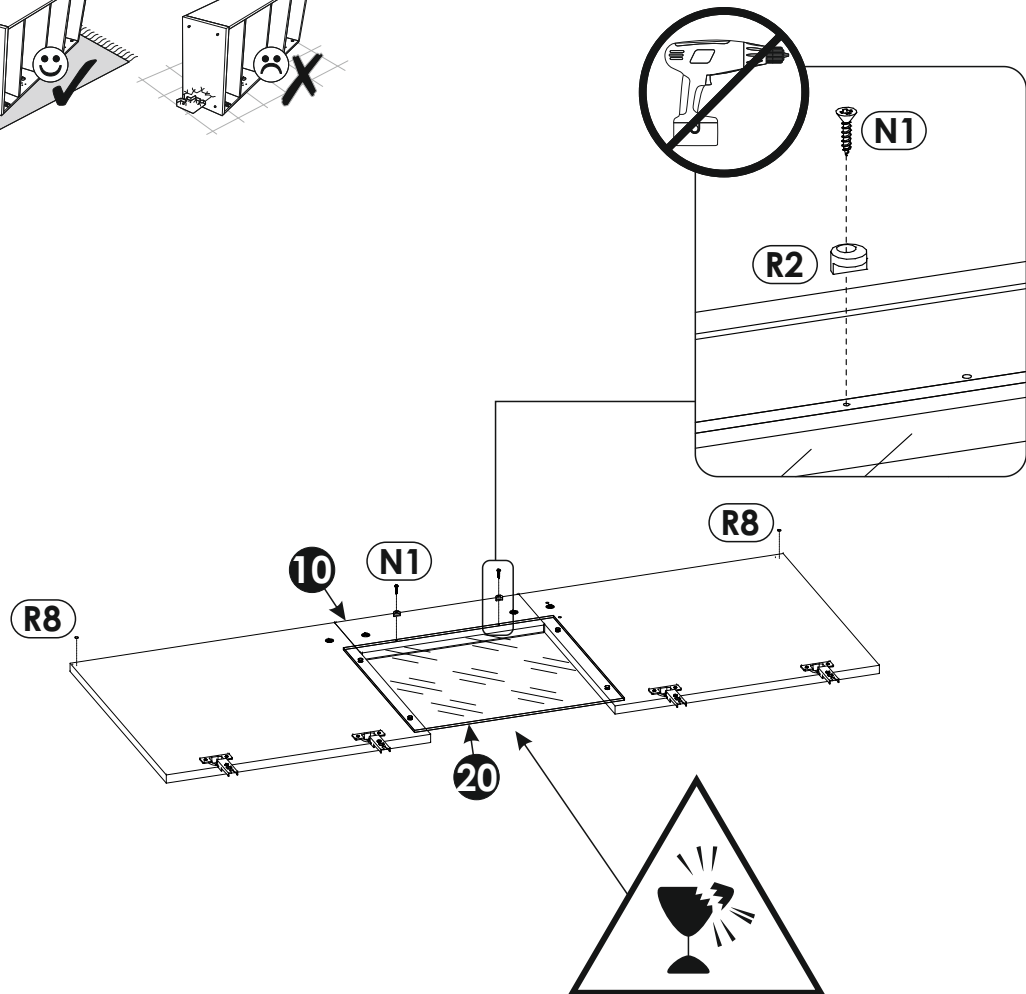
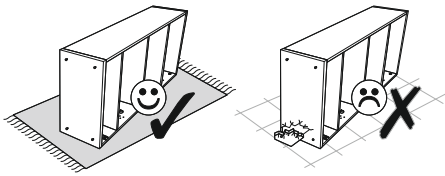

31 ▶

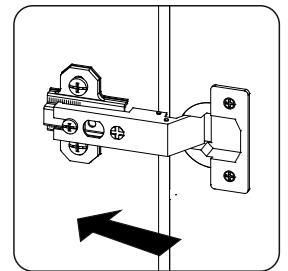
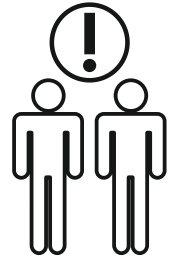
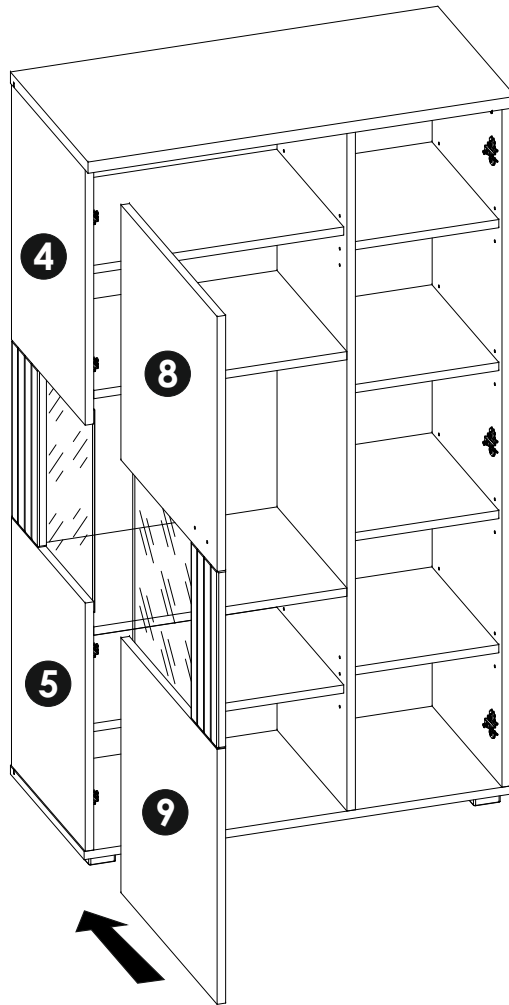

32 ▶

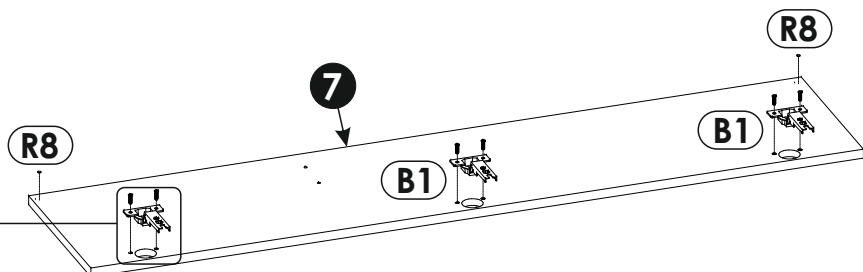
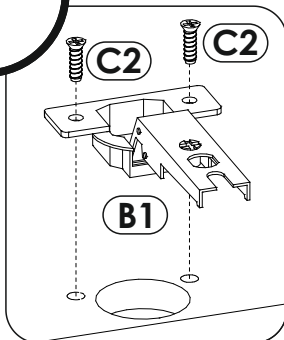
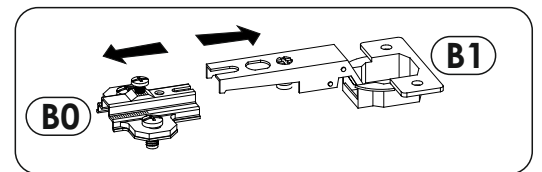
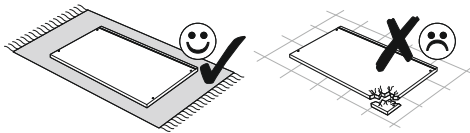

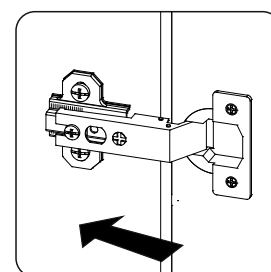
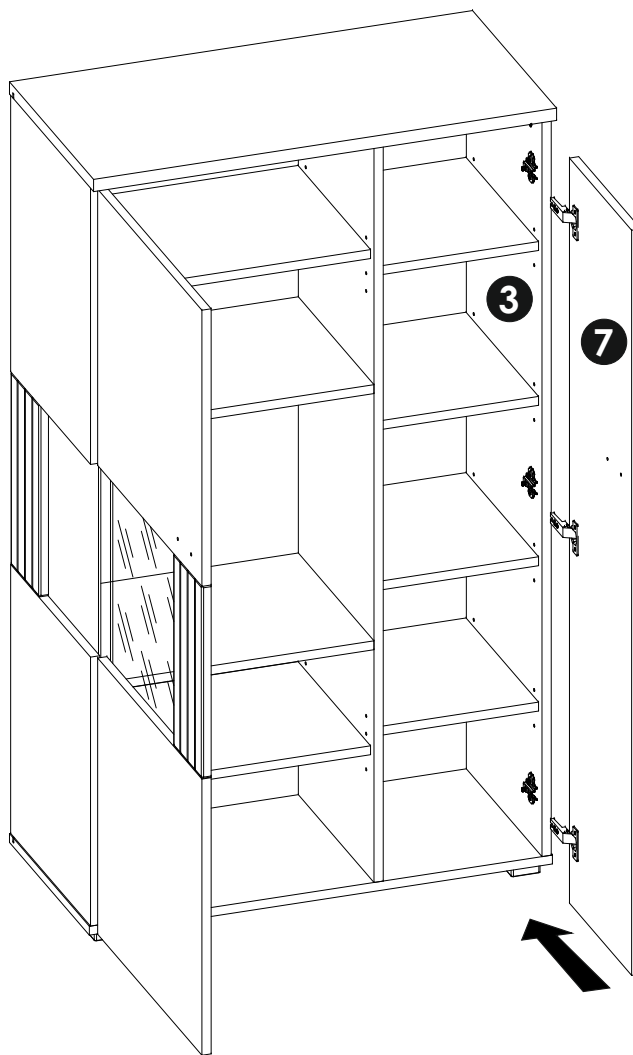

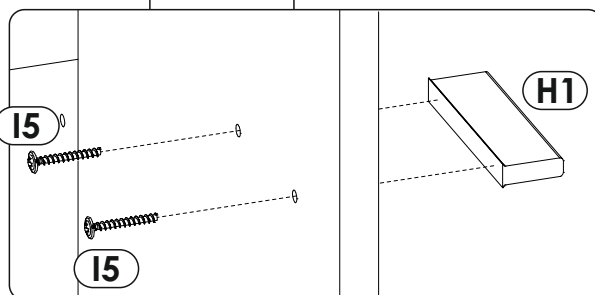
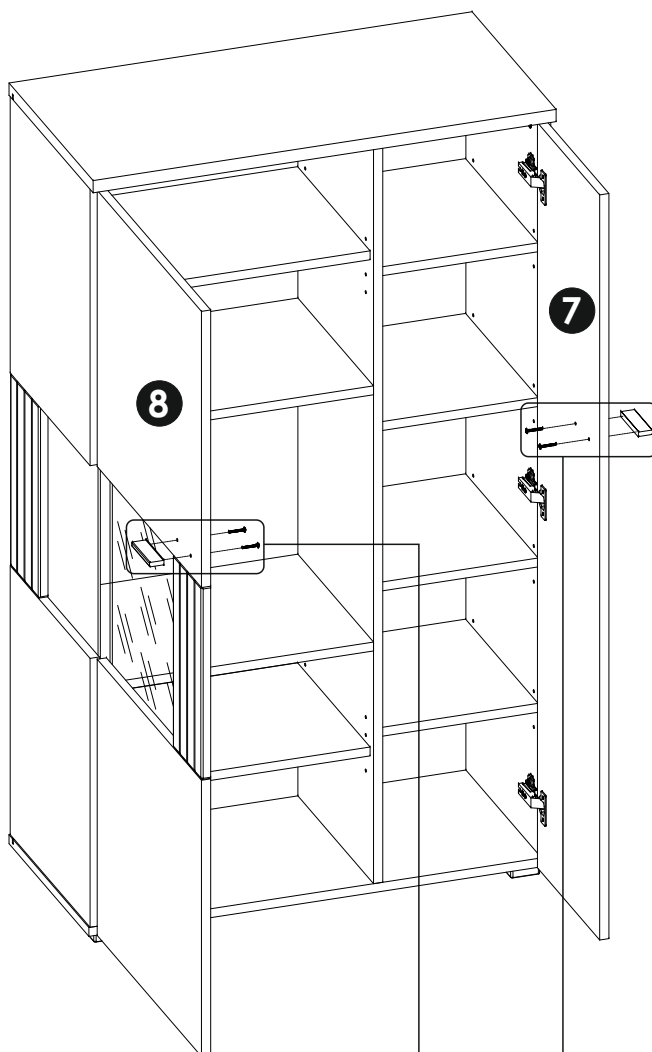

35 ▶

