

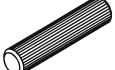









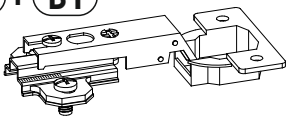

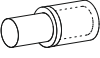
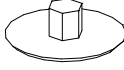

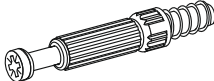

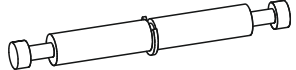



A1 8 x 35 mm x20 	A3 8 x 60 mm x4 	A8 6 x 45 mm x16 
B0 + B1 x8 	C2 5 x 13 mm x16 	D2 x16 
E0 Ø16 x22 	E1 15 x 12 mm x22 	E4 12 x 10 mm x16 
F1 6 x 34 mm x14 	F2 7 x 82 mm x4 	F3 7 x 64 mm x8 
G1 7 x 50 mm x6 	H1 x2 L - 84 mm 	I2 4 x 16 mm x18 
I4 3,5 x 27 mm x8 	I5 3,5 x 27 mm x4 	M x1 
N1 3 x 16 mm x30 	O4 x4 	O5 x1 
P15 x2 	P16 x16 	Q9 x2 
R1 x21 	R2 x8 	R3 x16 
R4 x10 	R8 x4 	S13 x2 Ø8 
Z x1 		

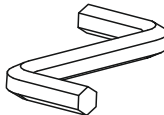

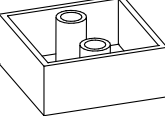
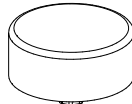

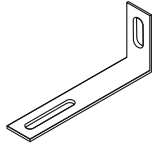
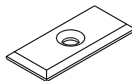
1	1002	400	22	x1	2/2
2	1000	380	16	x1	2/2
3	499	380	16	x1	2/2
4	346	136	16	x2	2/2
5	483	380	16	x1	2/2
6	394	262	4	x2	2/2
7	499	380	16	x1	2/2

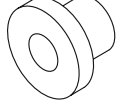
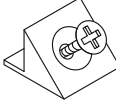
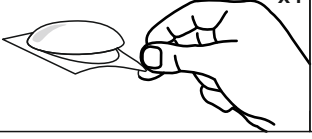
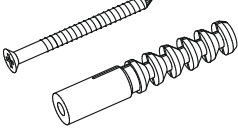
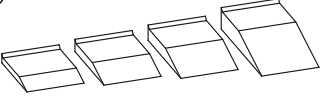
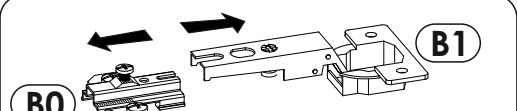
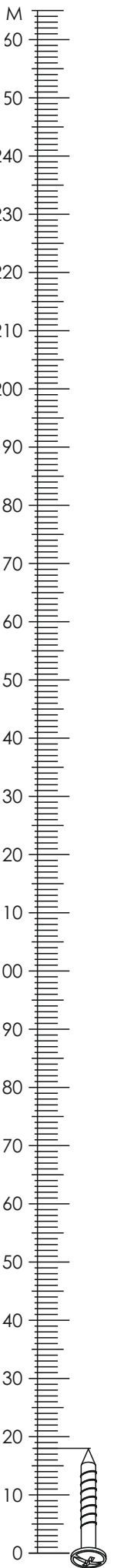
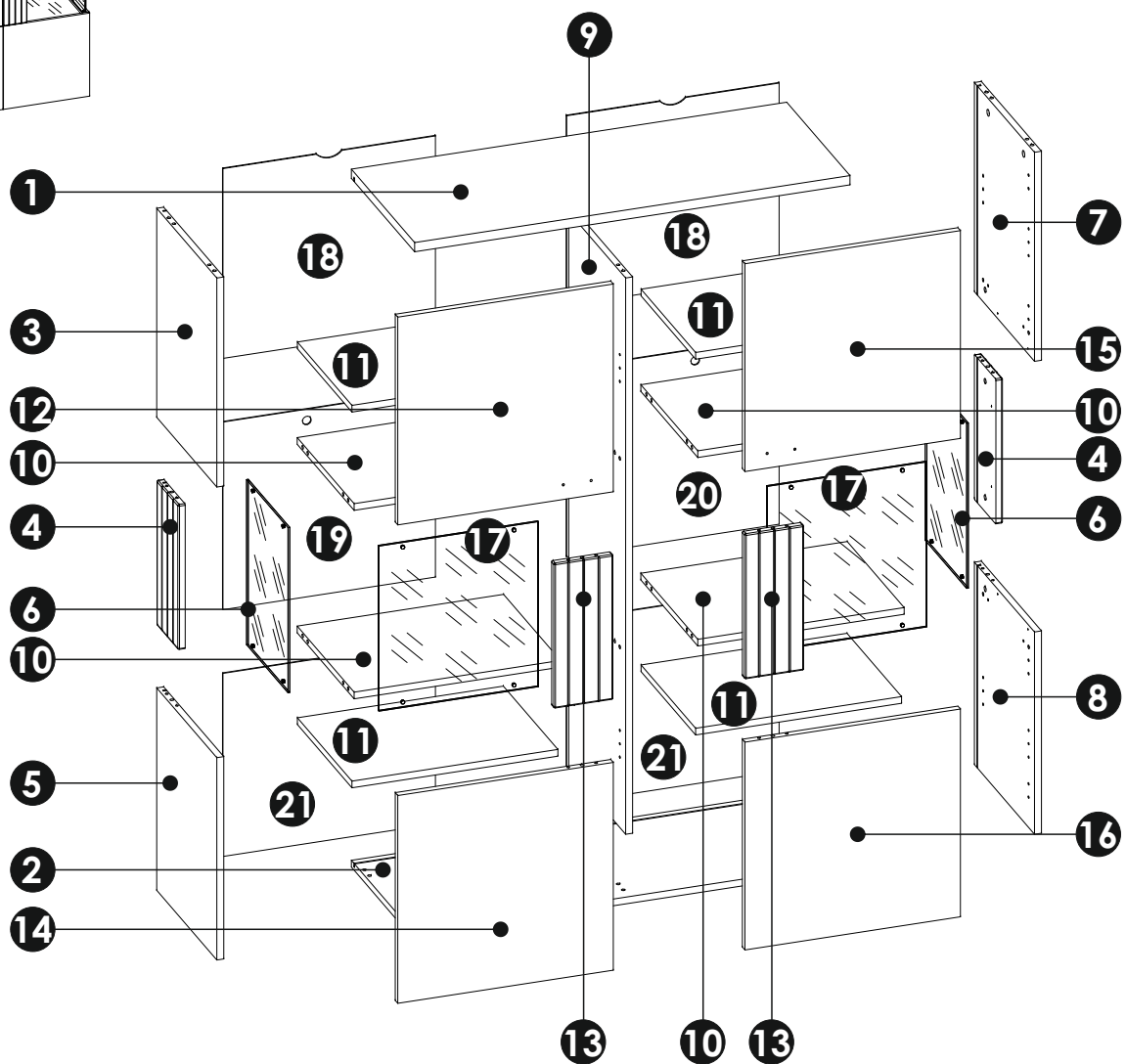
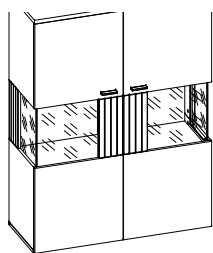
8	483	380	16	x1	2/2
9	1328	360	16	x1	2/2
10	475	360	16	x4	1/2
11	474	345	16	x4	1/2
12	496	496	16	x1	1/2
13	346	136	16	x2	2/2
14	496	496	16	x1	1/2

15	496	496	16	x1	1/2
16	496	496	16	x1	1/2
17	394	367	4	x2	2/2
18	453	489	3	x2	1/2
19	448	489	3	x1	1/2
20	448	489	3	x1	1/2
21	437	489	3	x2	1/2

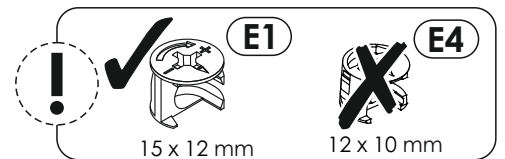
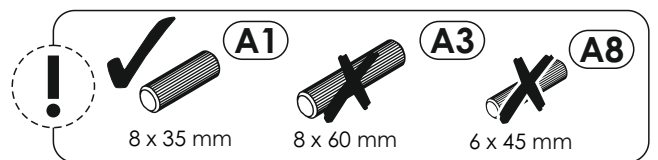
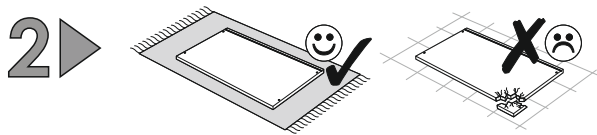
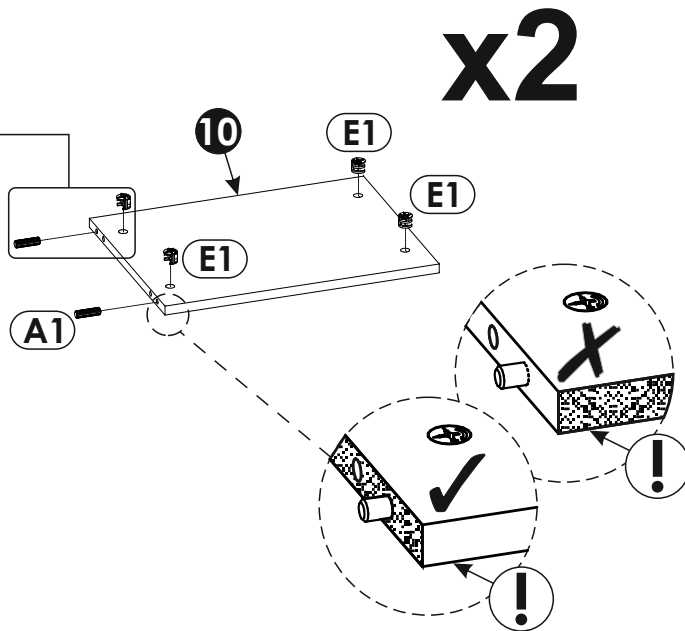
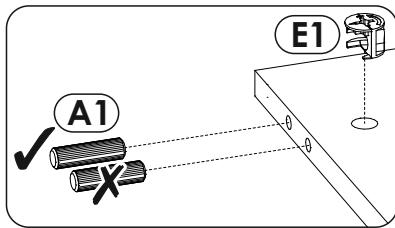
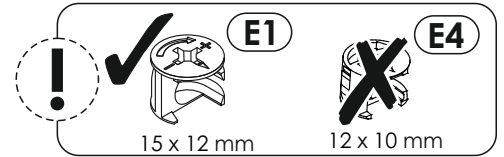
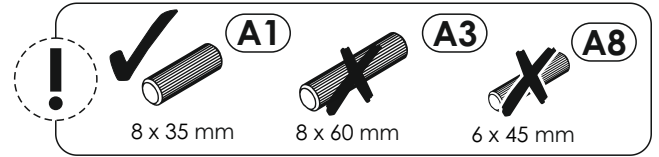
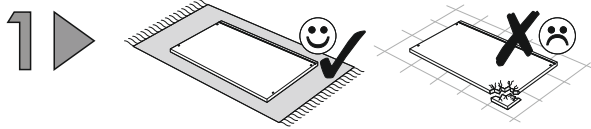
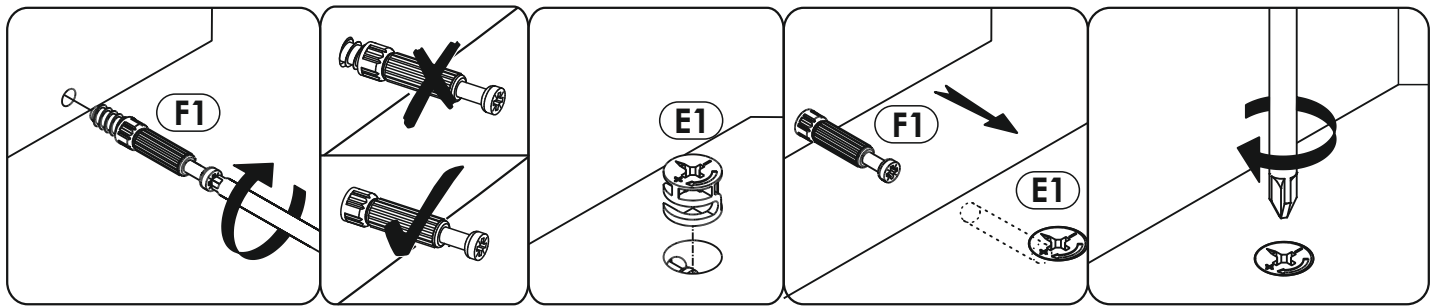

x2

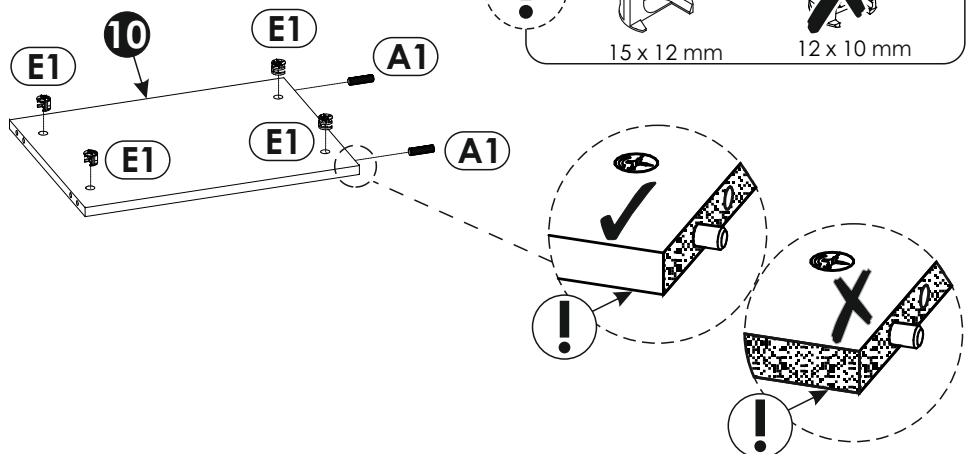

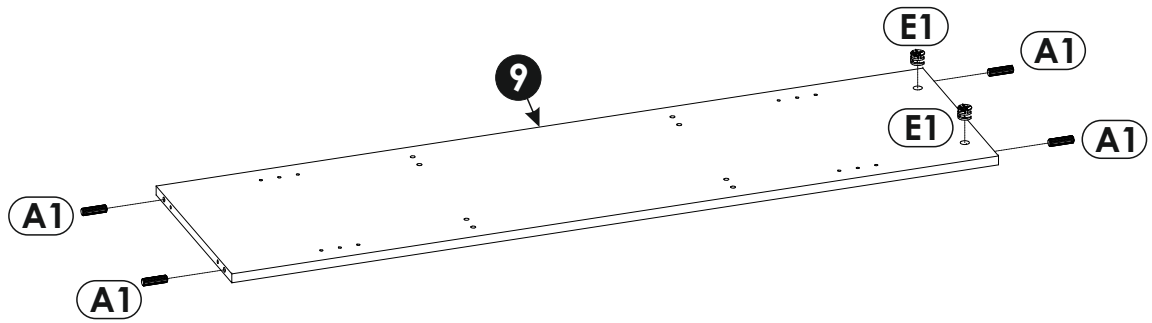
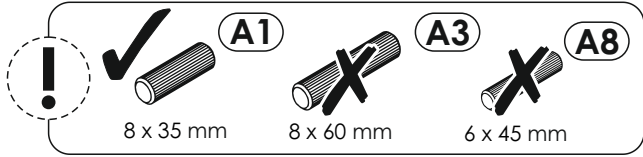
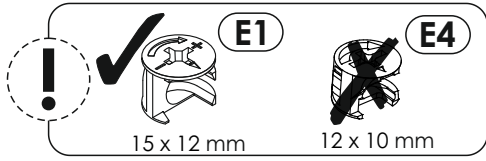
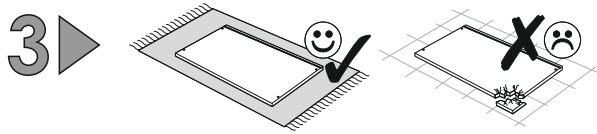

4 ▶

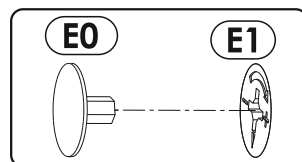
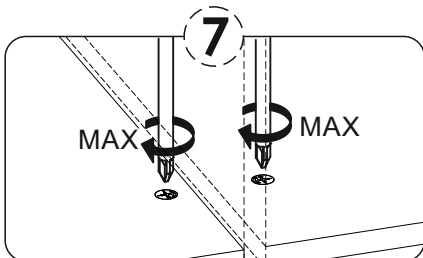
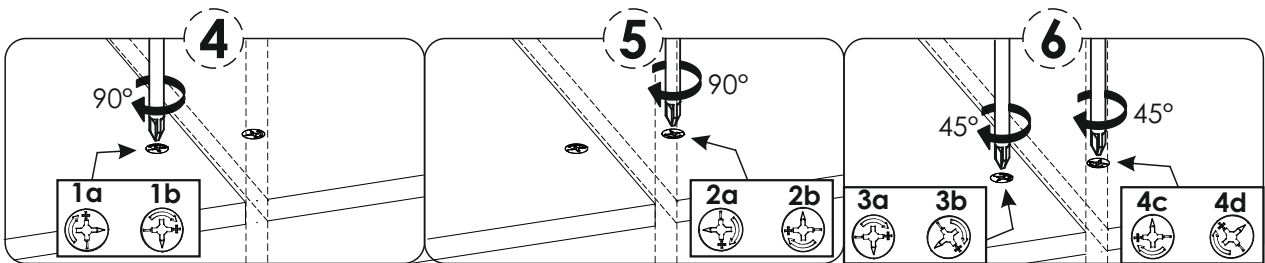
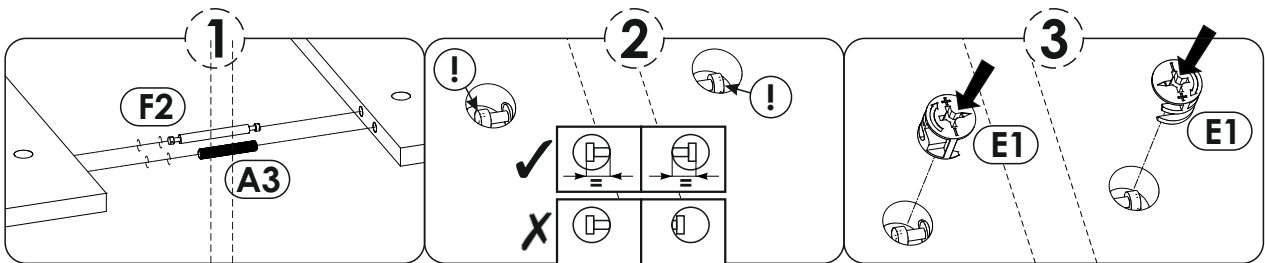
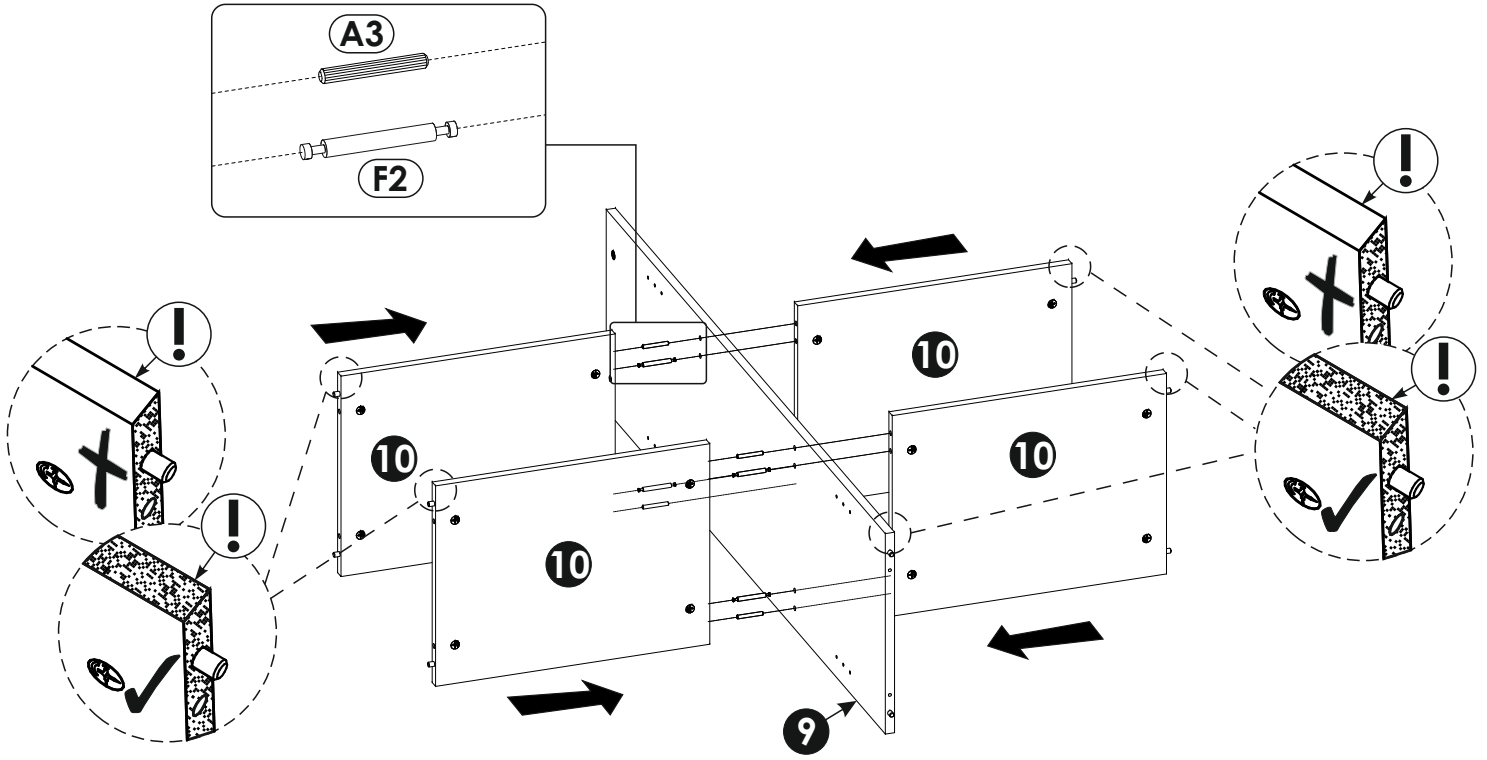
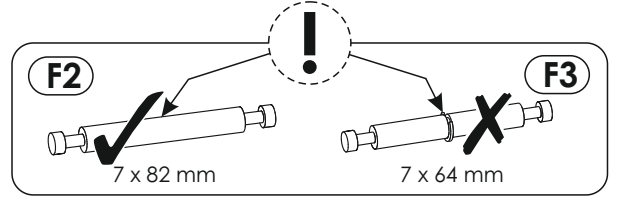
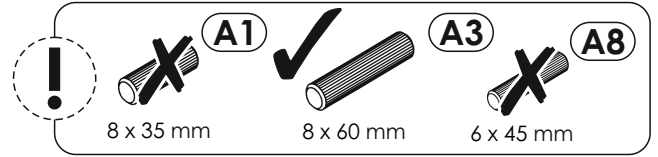
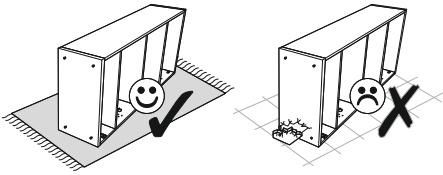

5 ▶

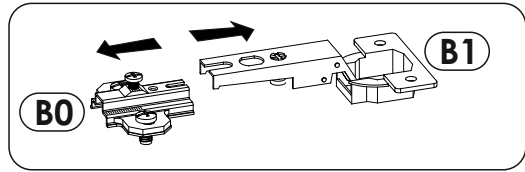
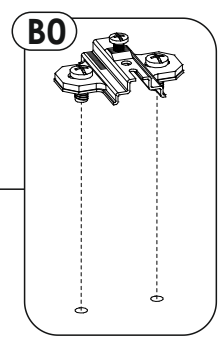
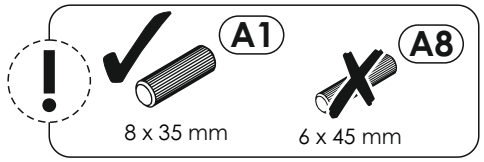
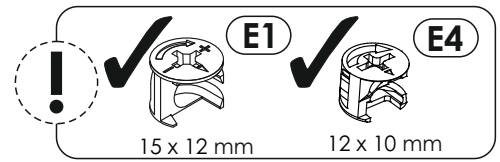
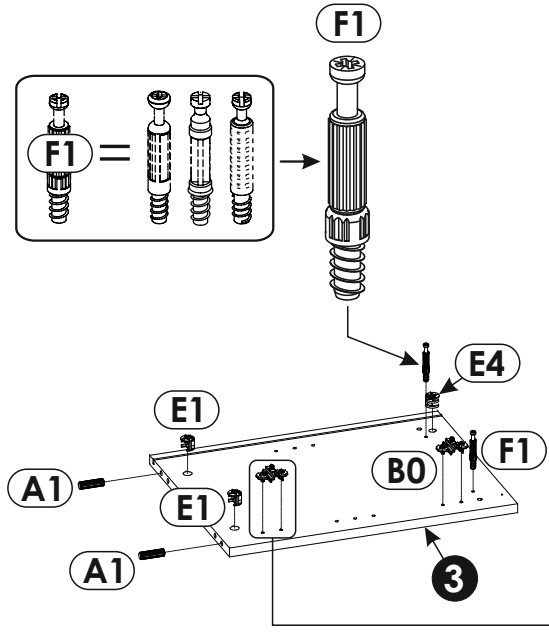
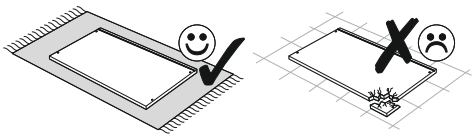

6 ▶

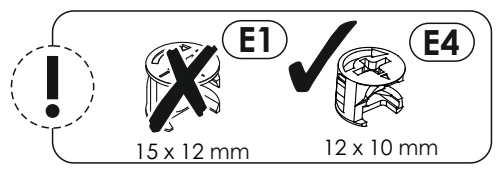
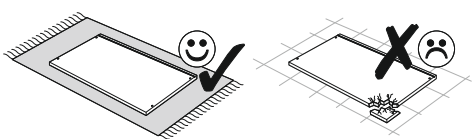

x2

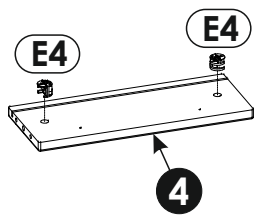

7 ▶

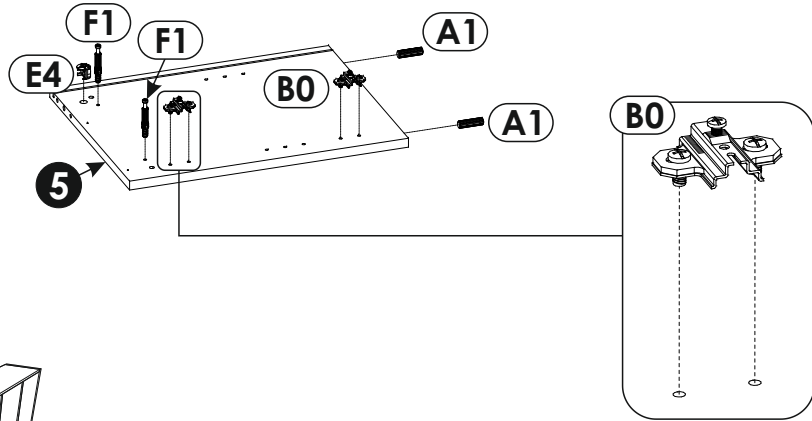
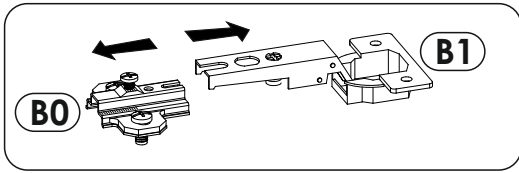
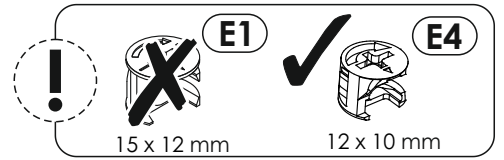
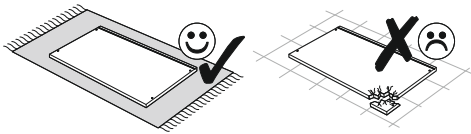

8 ▶

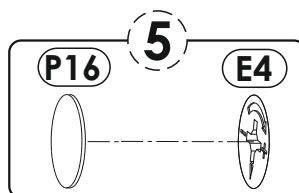
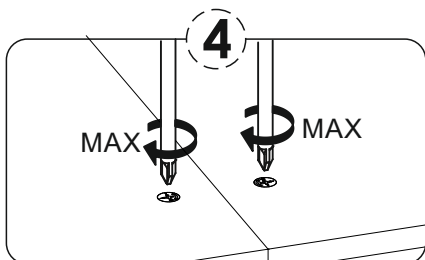
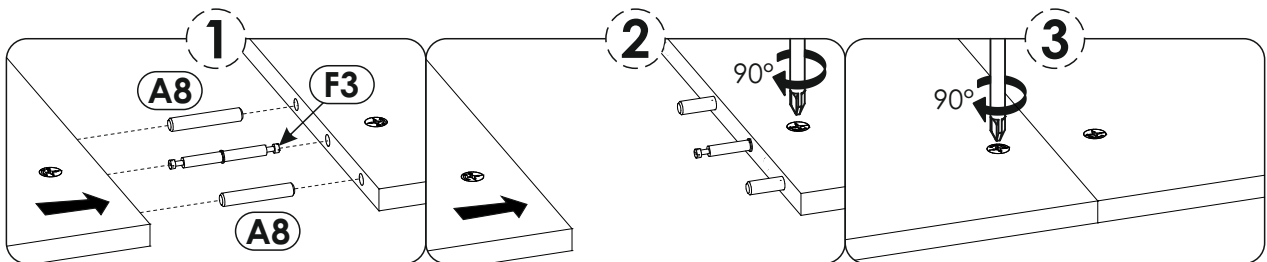
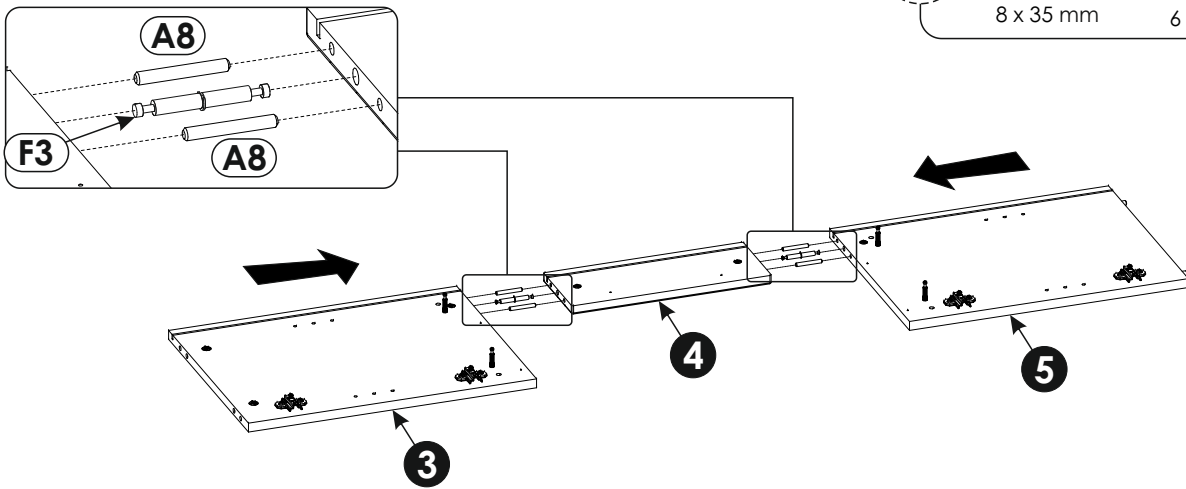
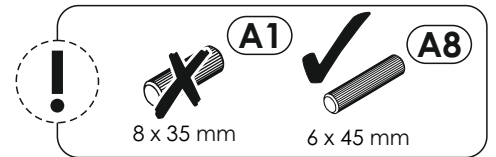
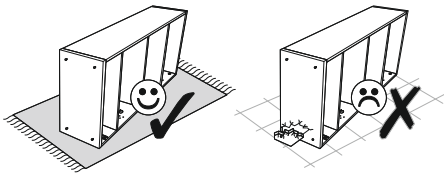

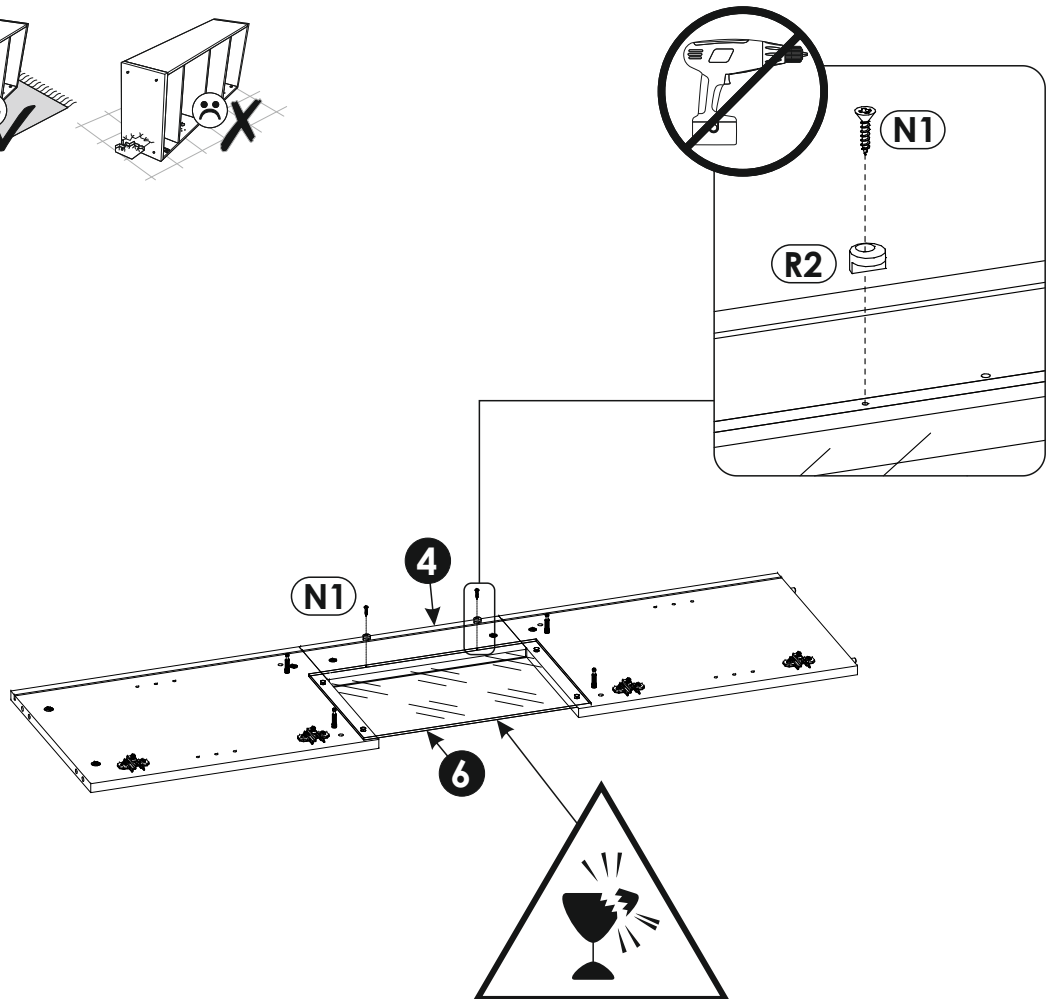
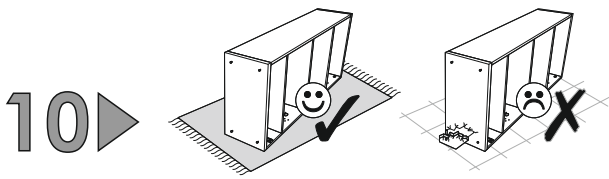
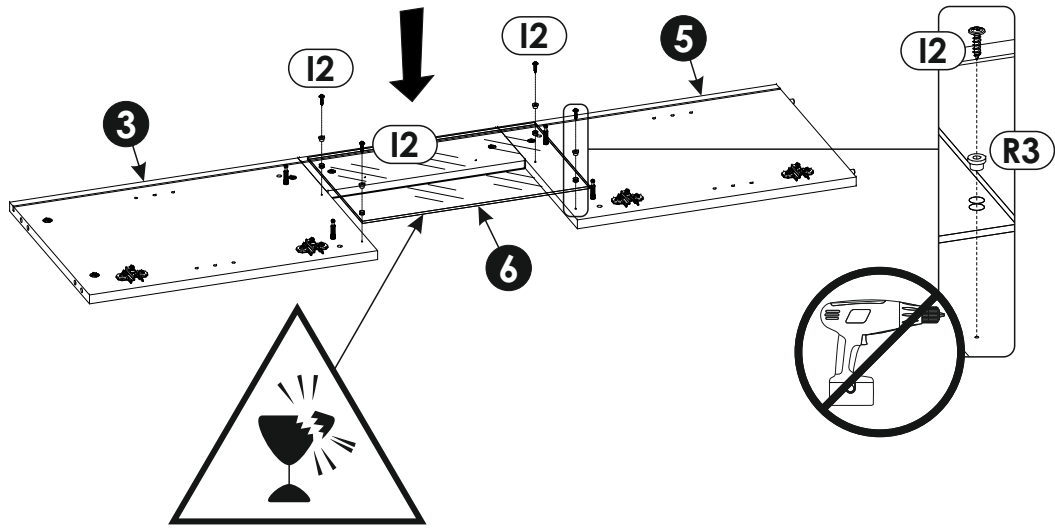
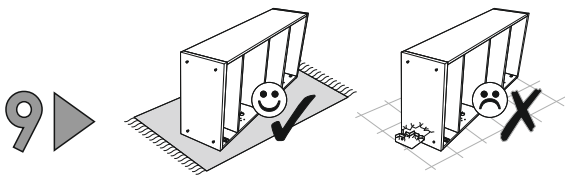

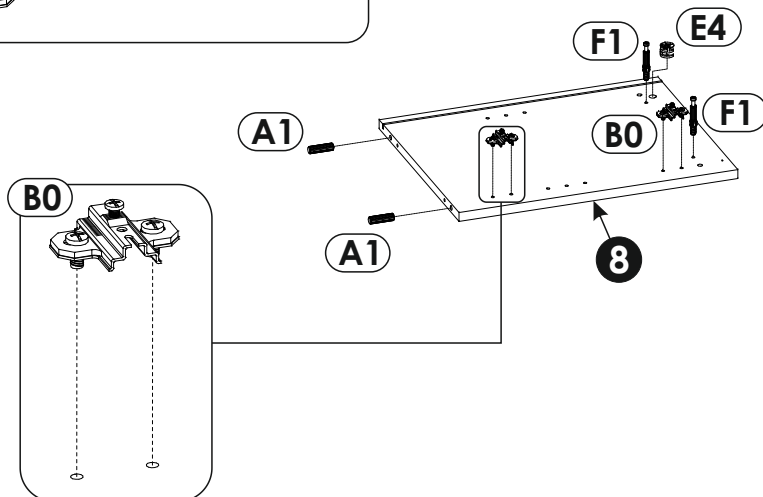
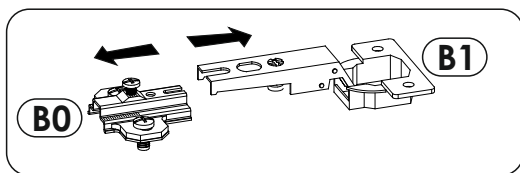
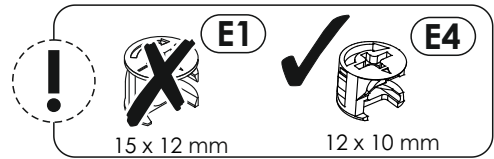
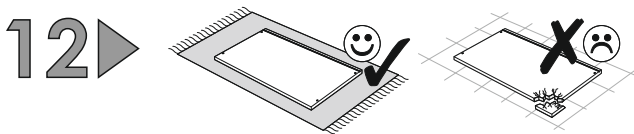
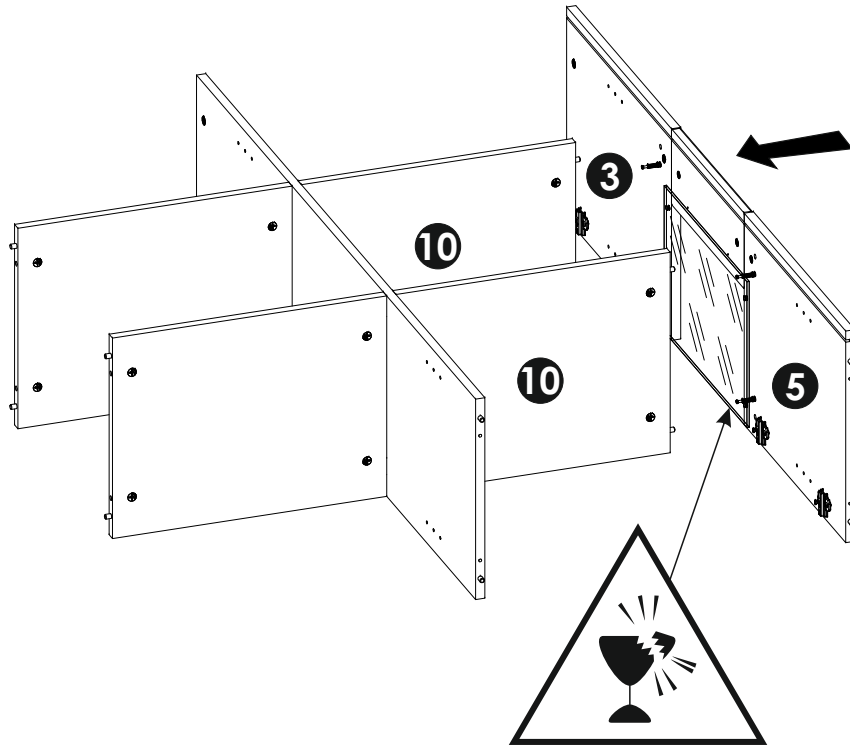
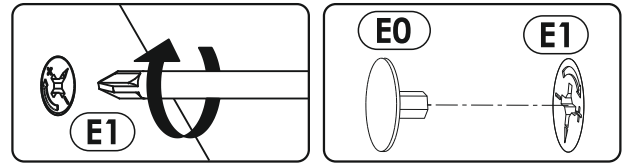
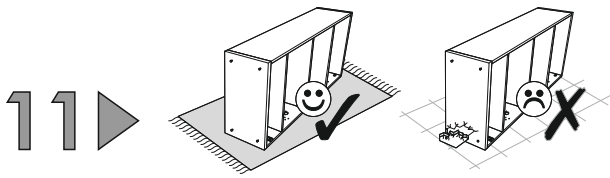

13 ▶

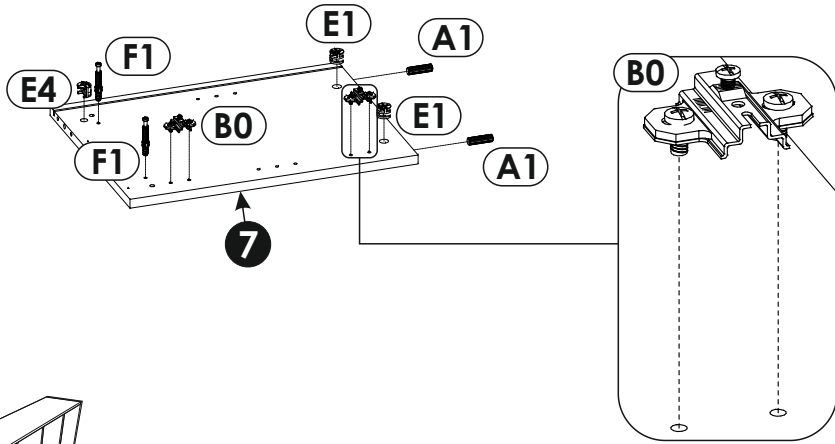
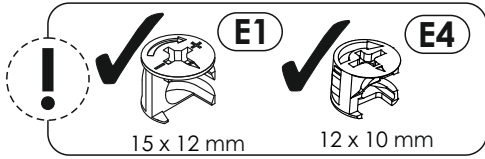
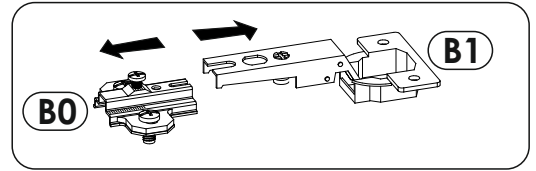
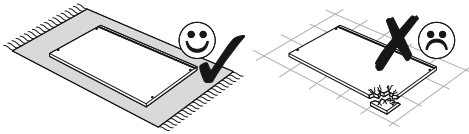

14 ▶

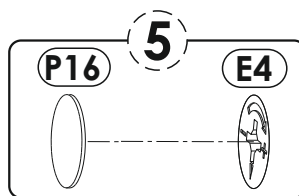
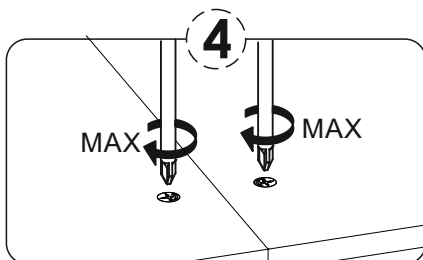
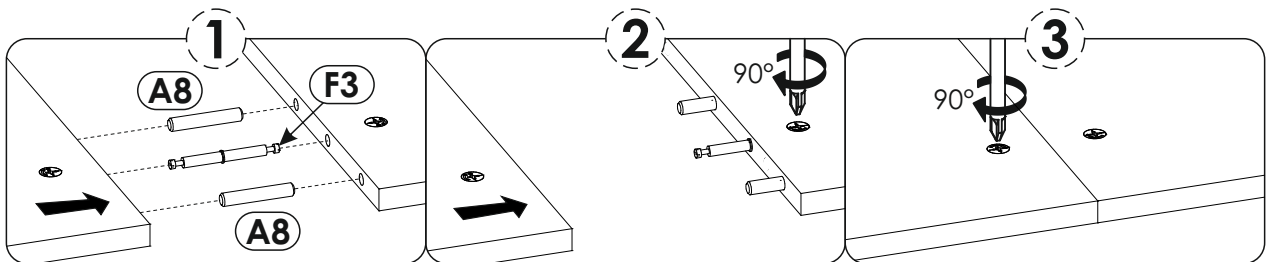
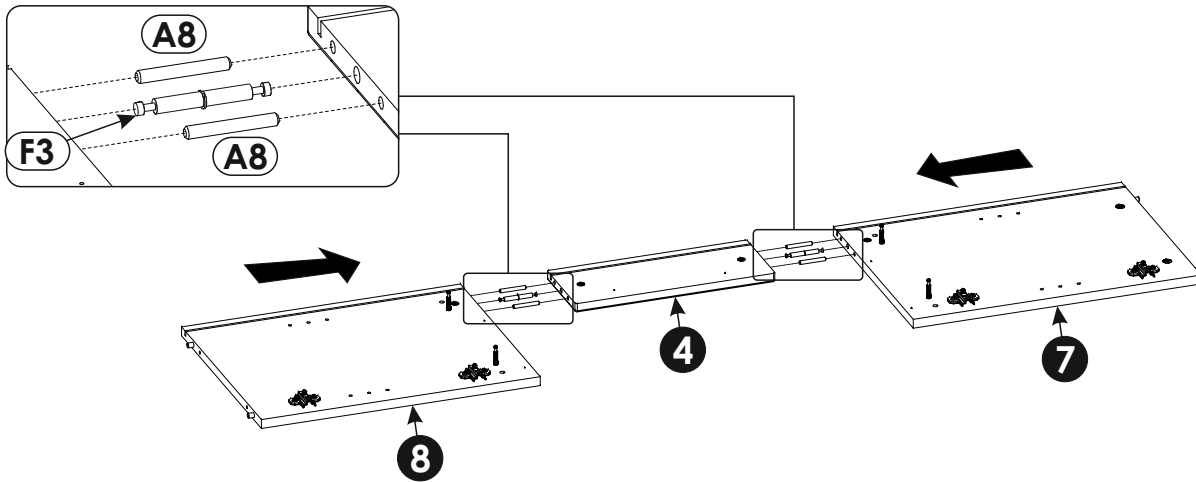
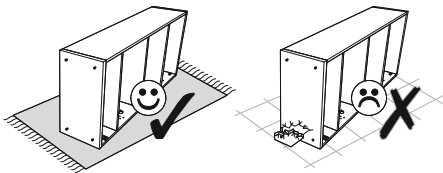

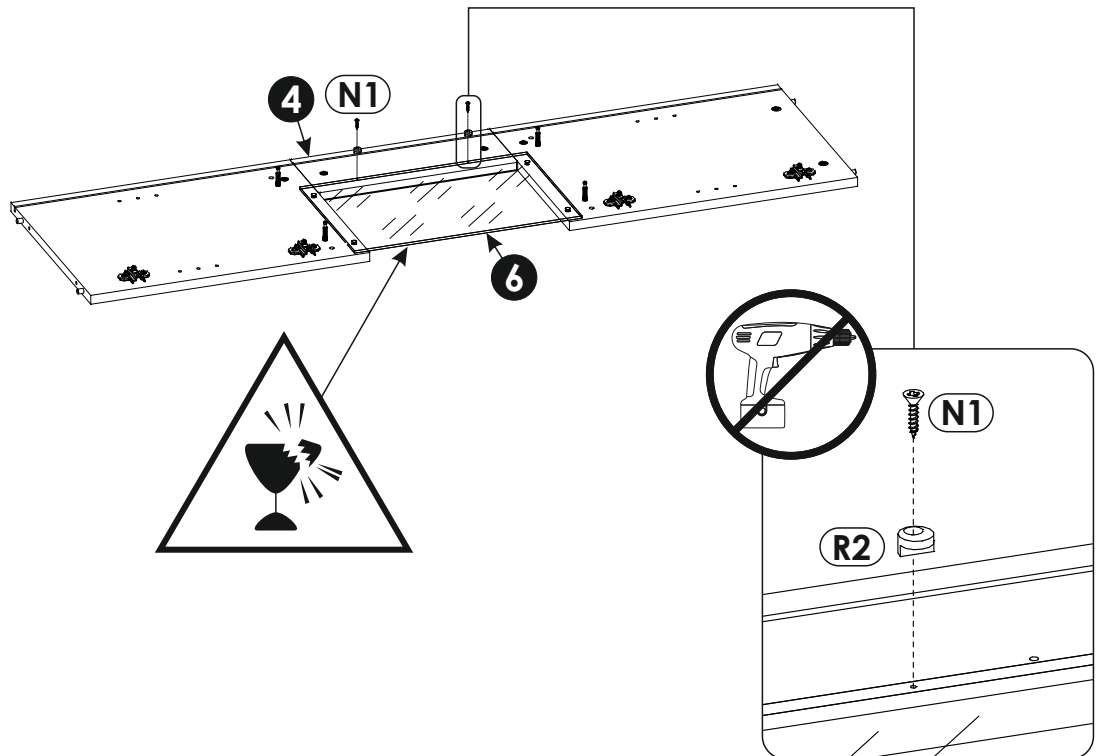
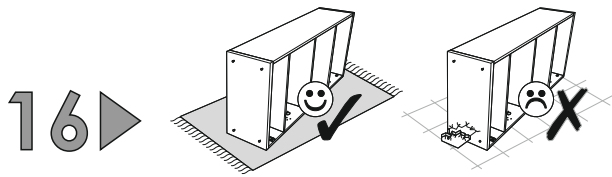
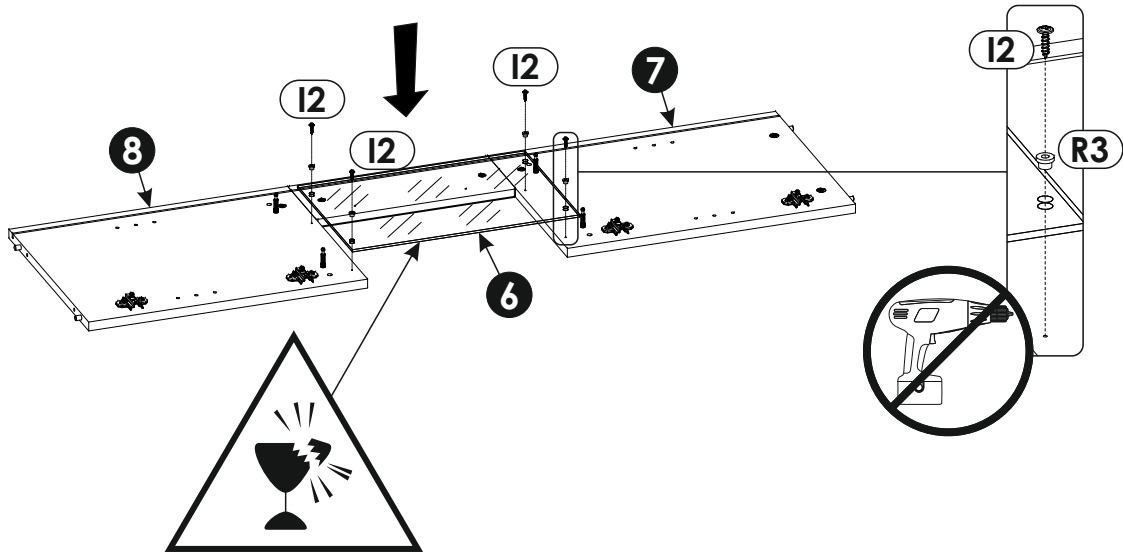
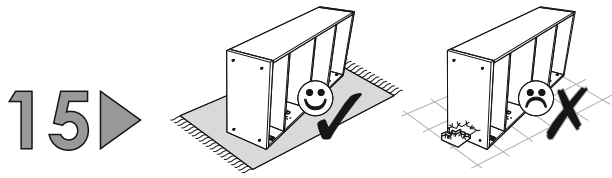

17▶

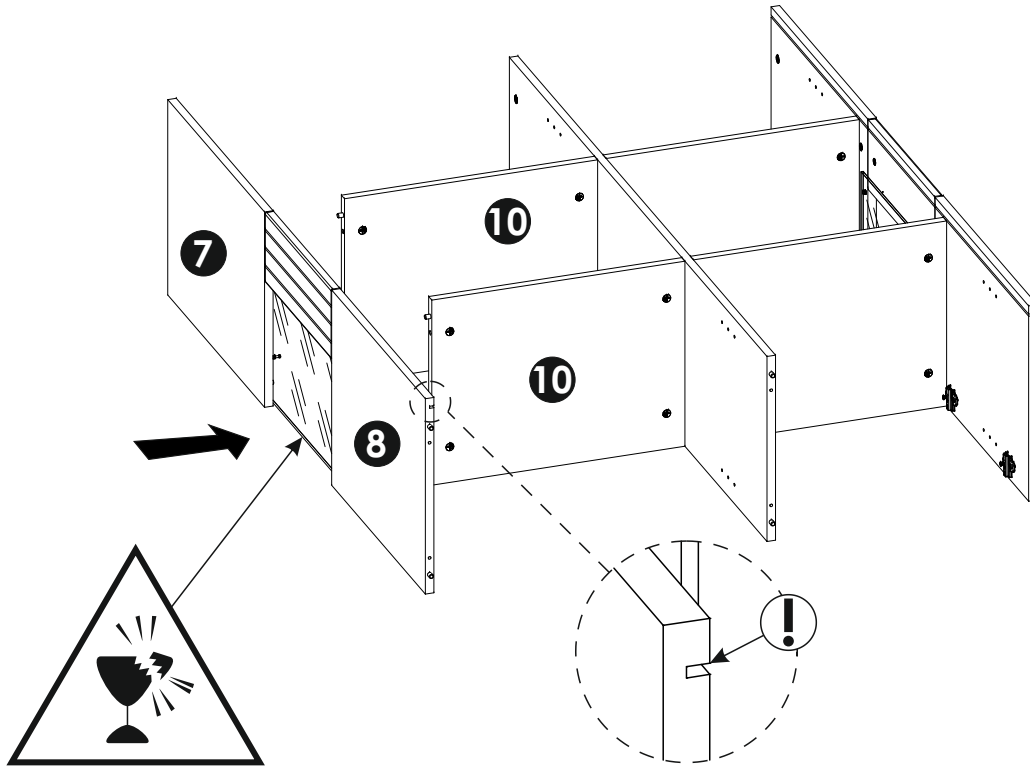
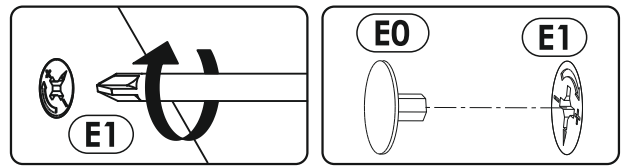
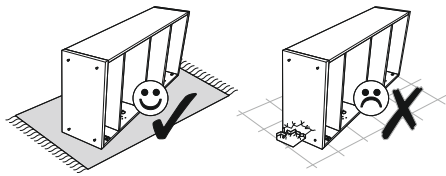

18▶

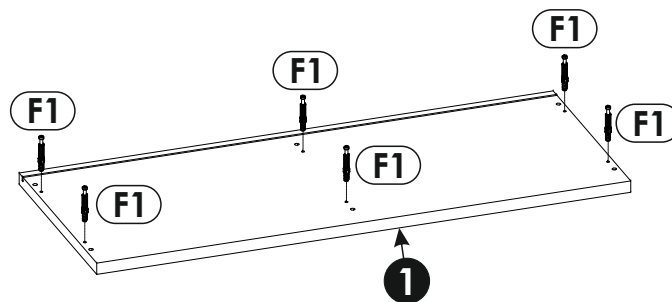
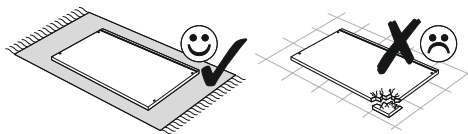

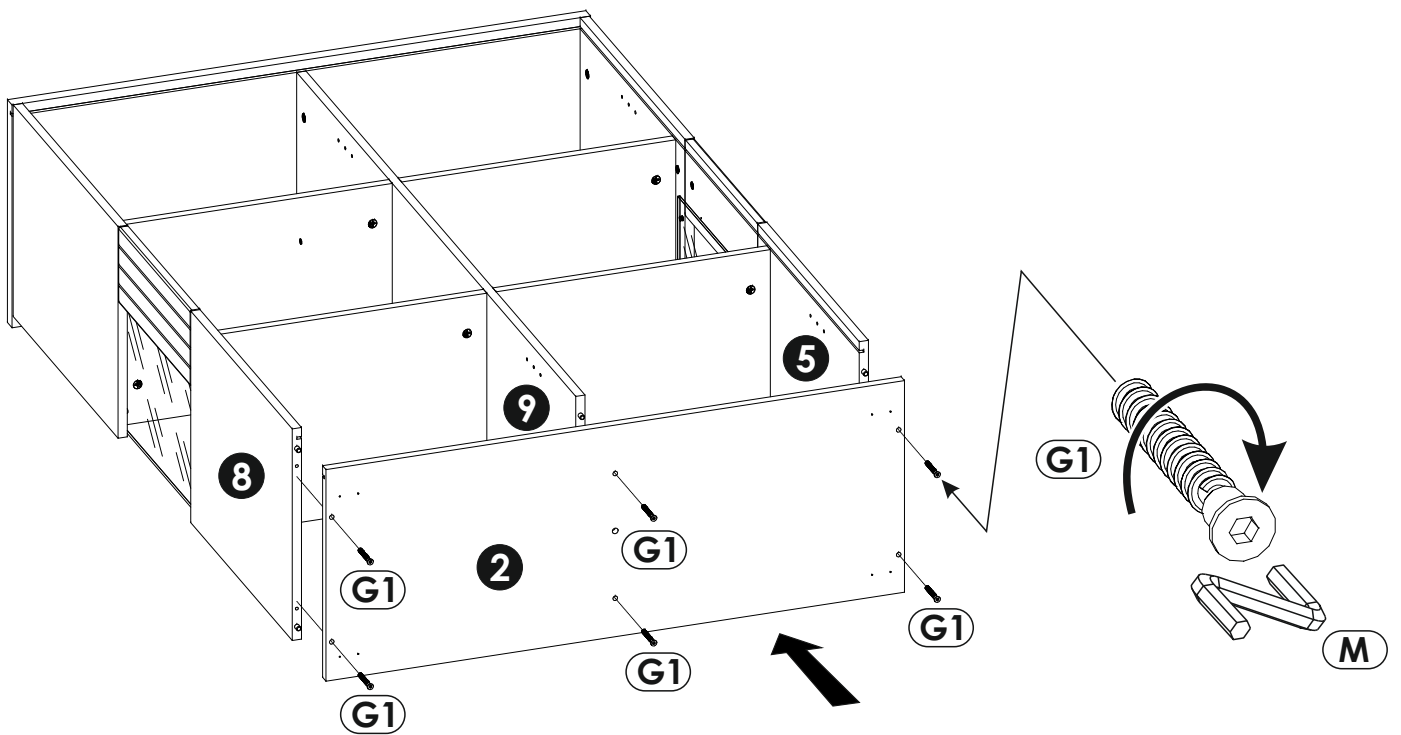
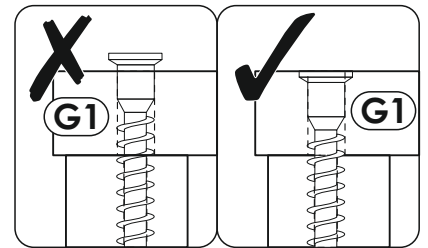
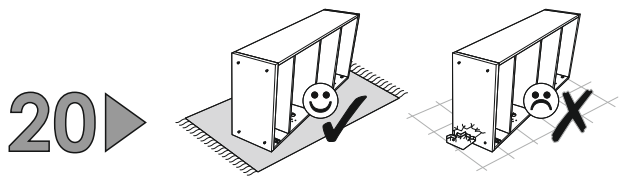
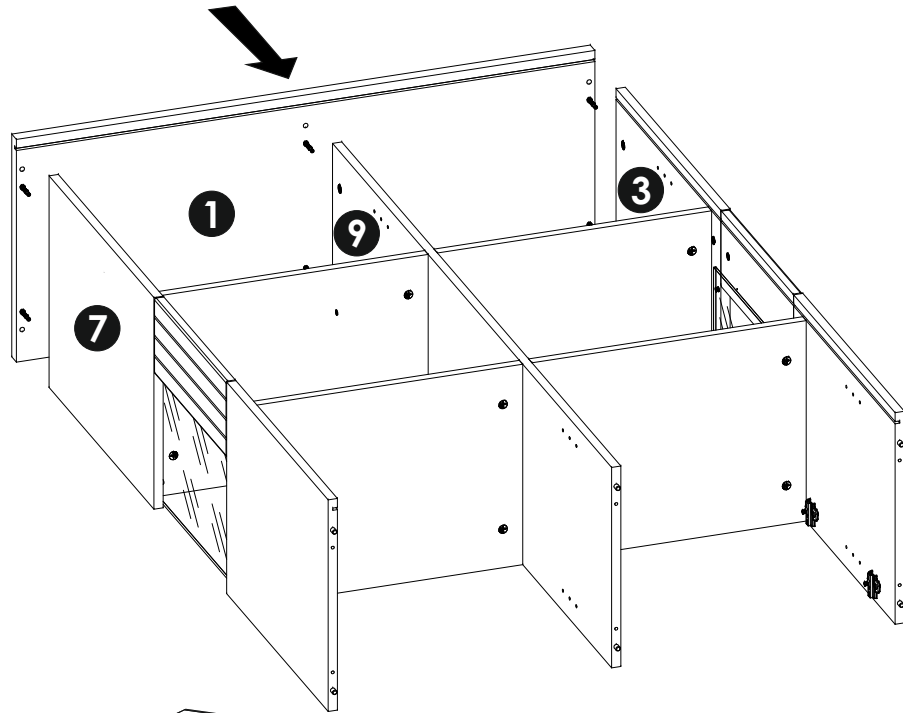
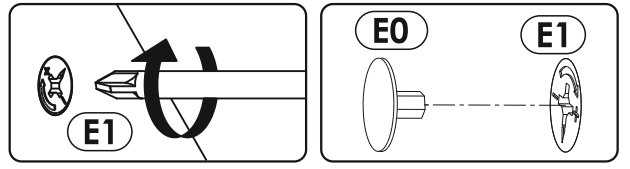
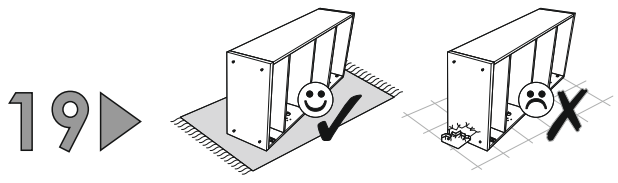

21 ▶

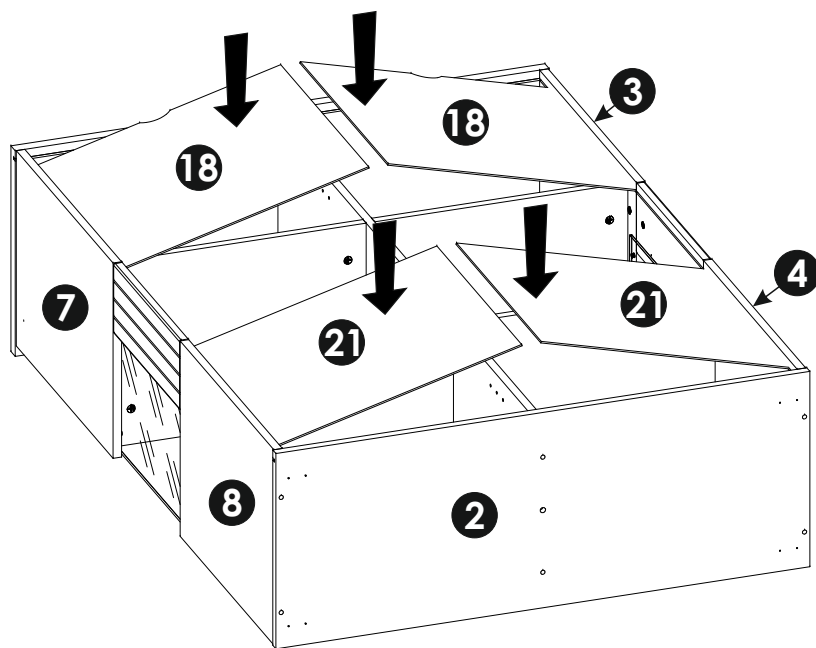
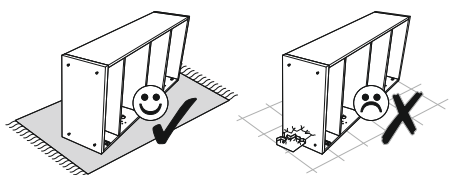

22 ▶

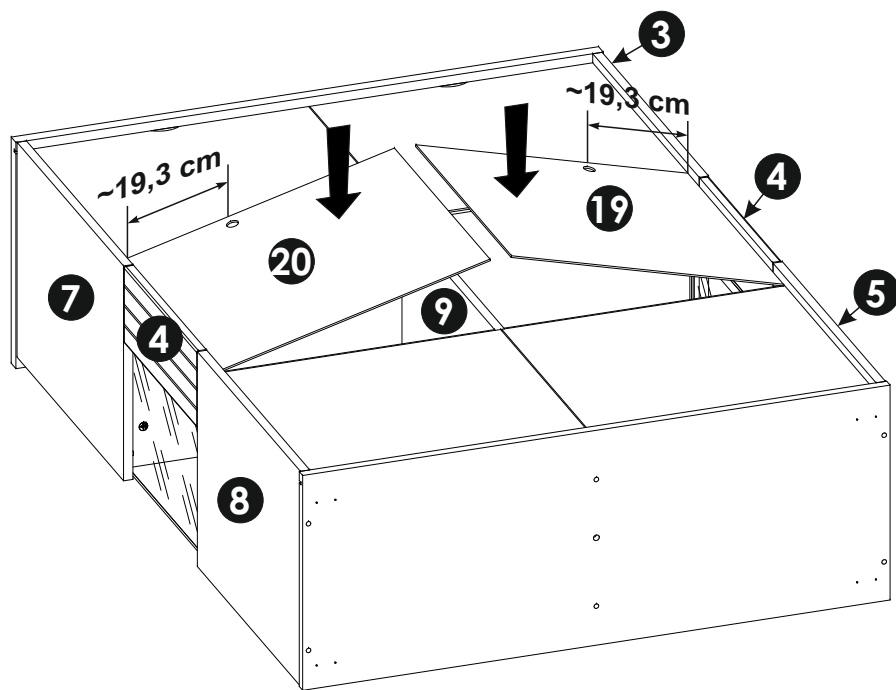
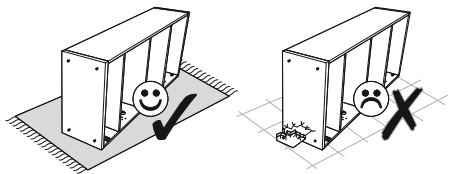

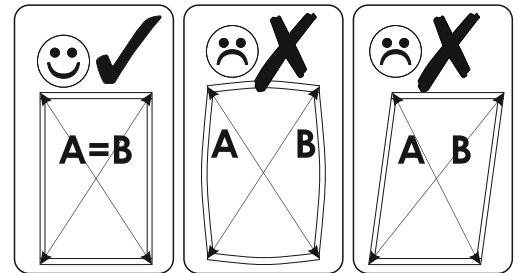
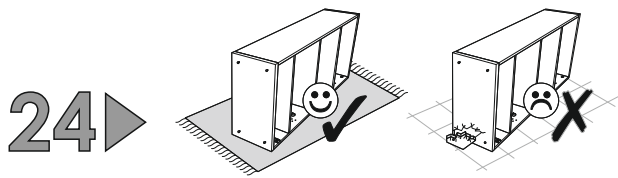
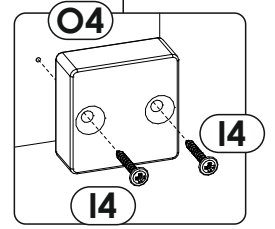
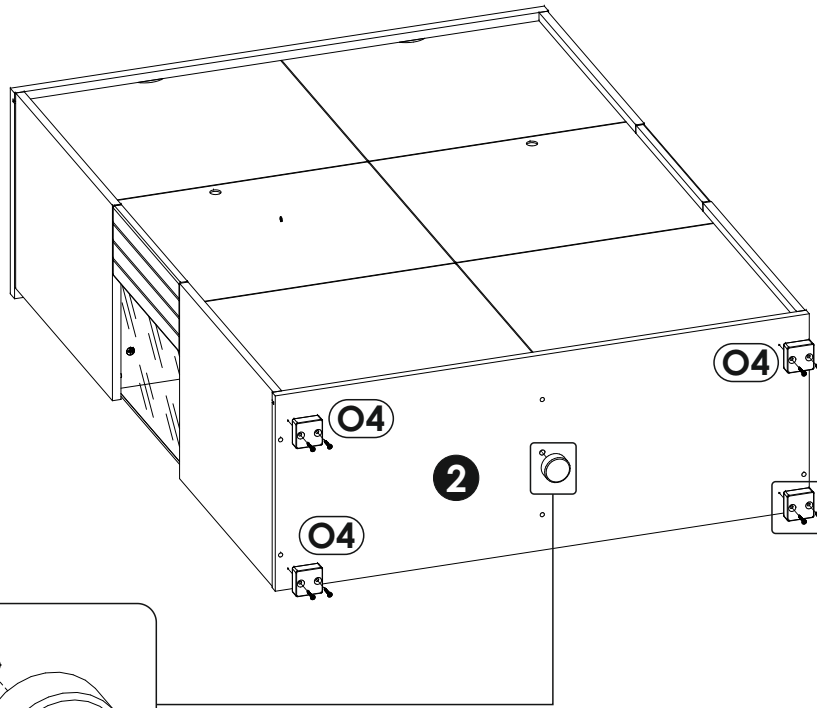
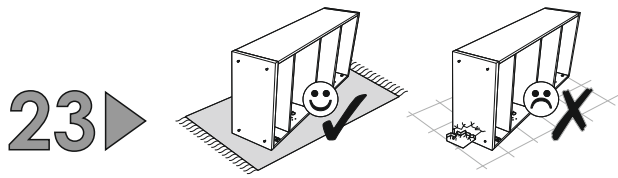

A=B

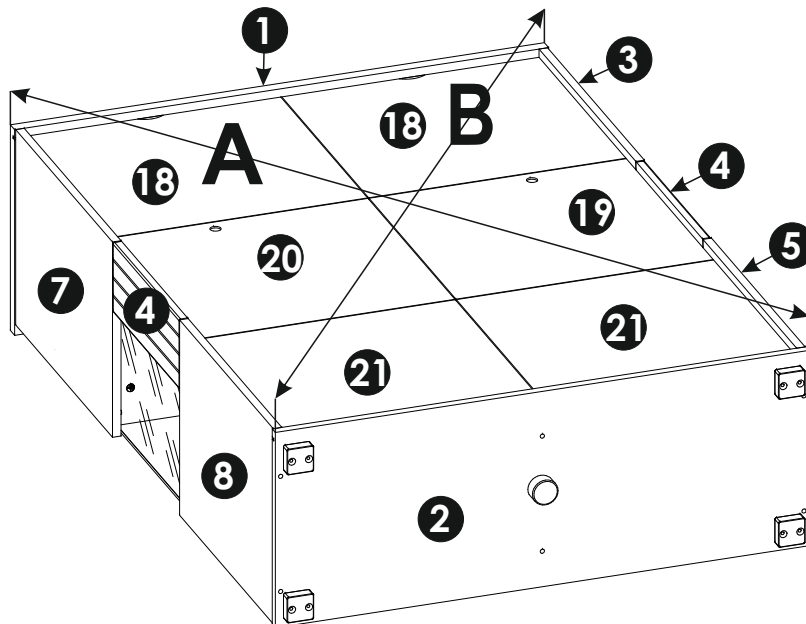

25 ▶

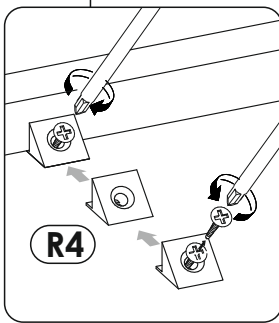
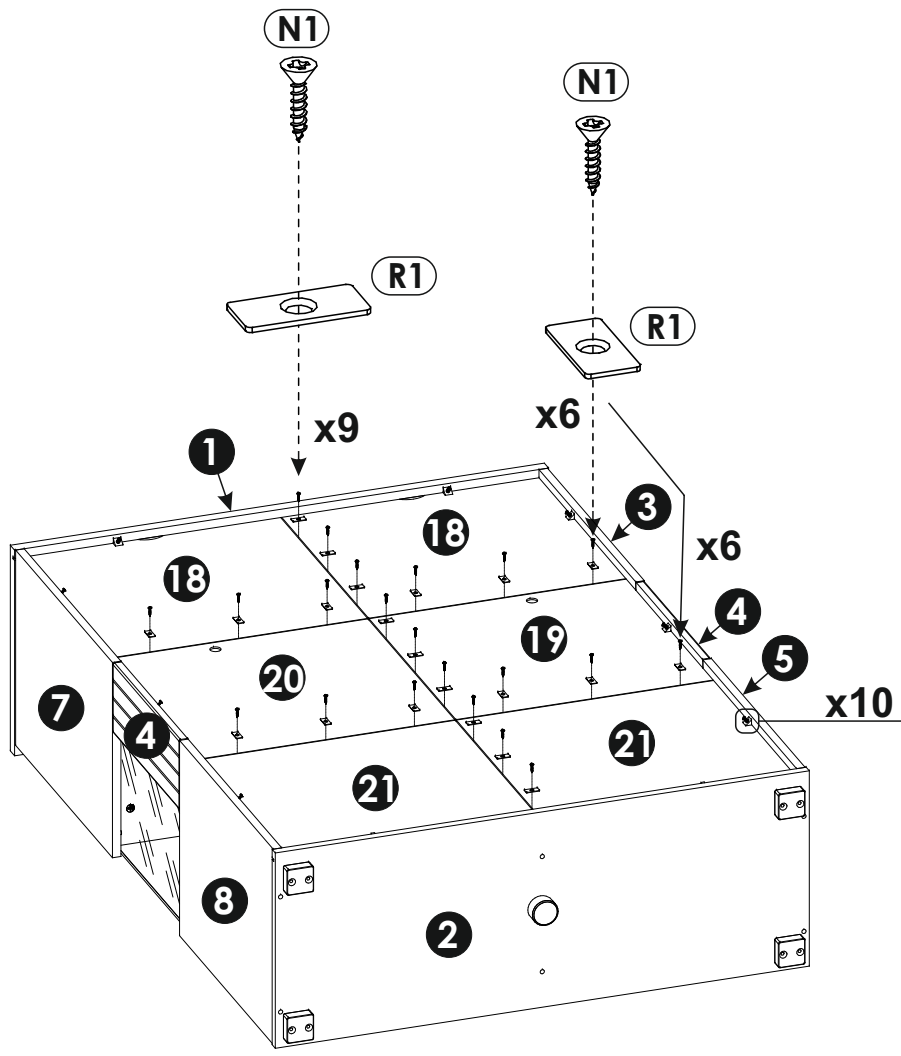
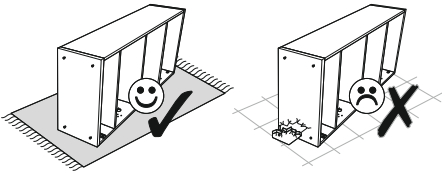

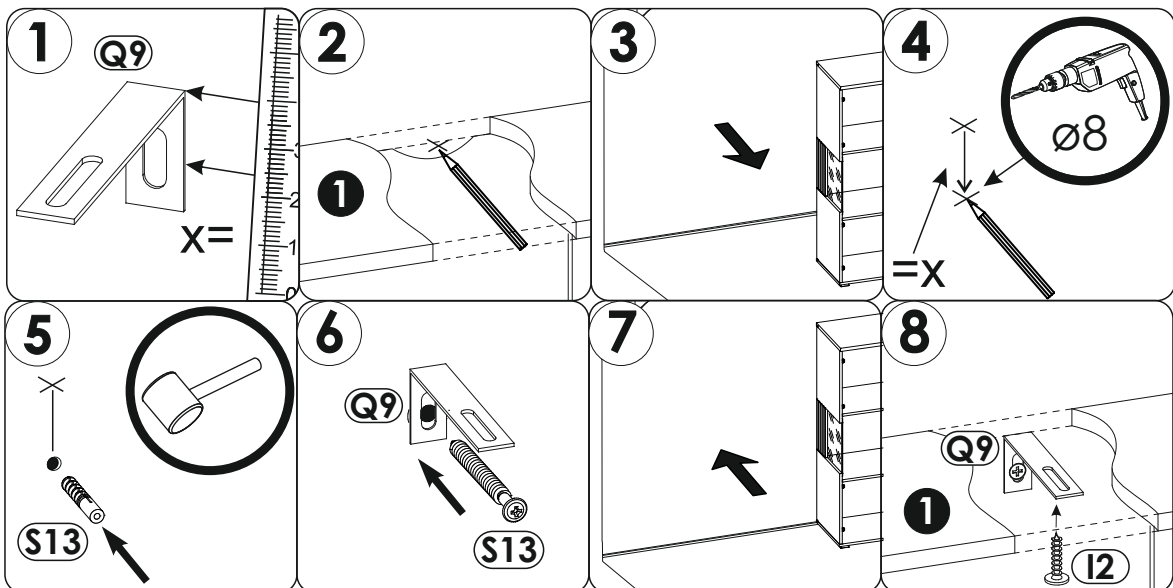
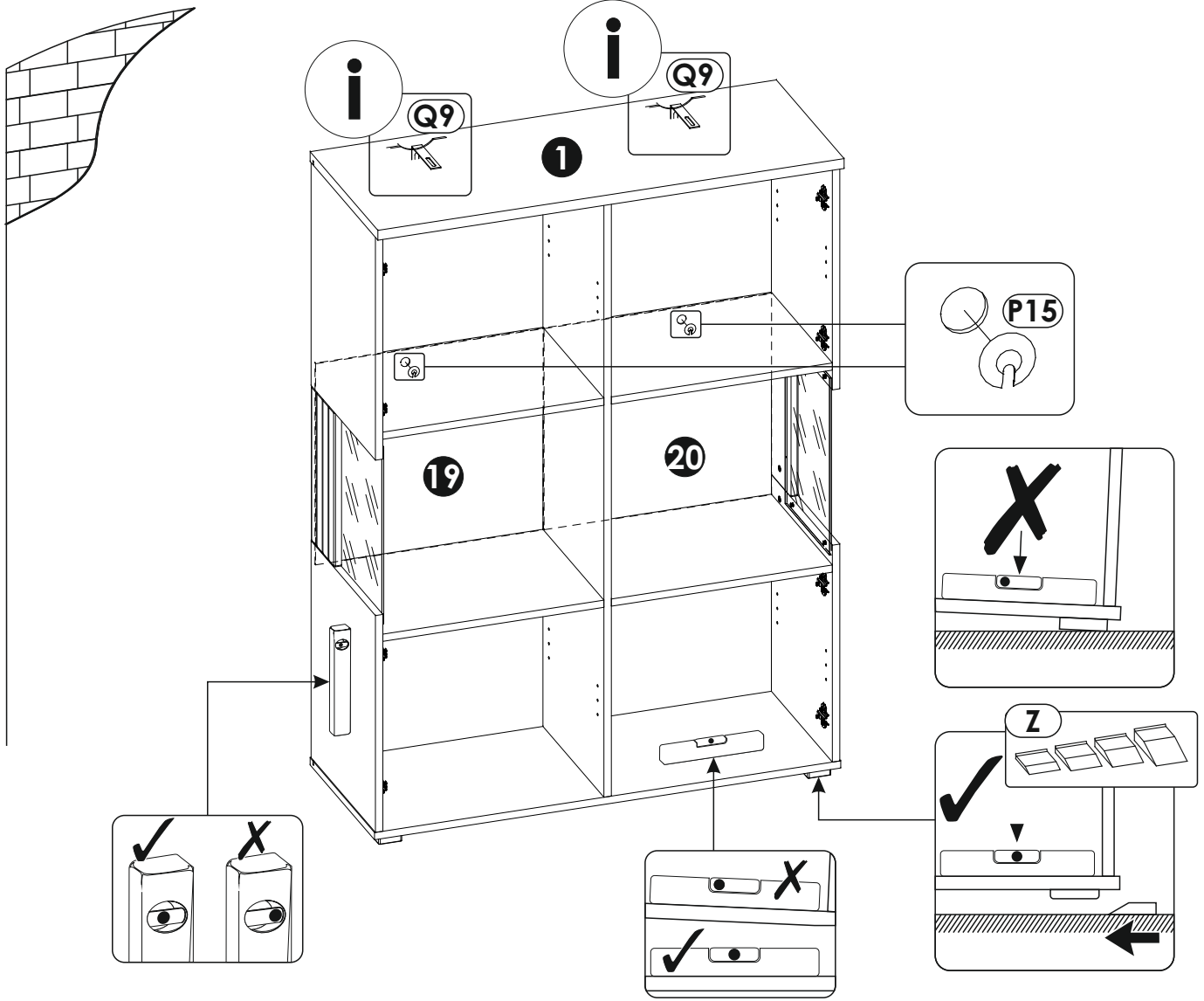
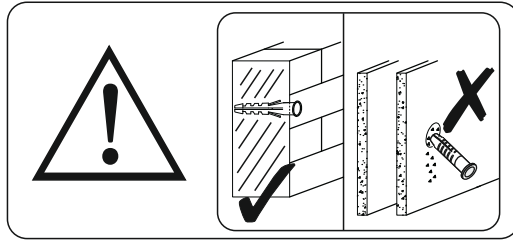

27▶

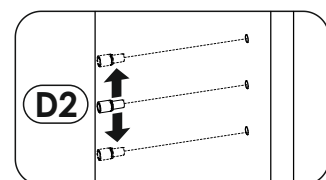
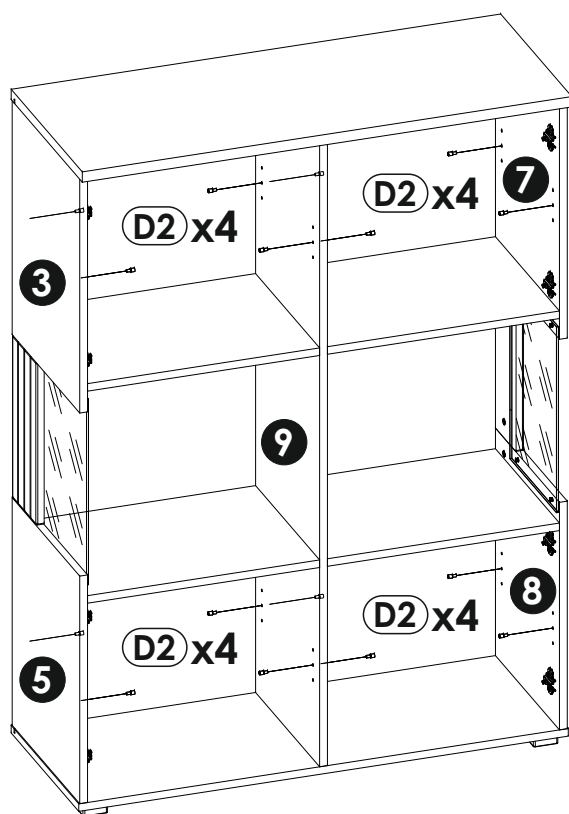

28▶

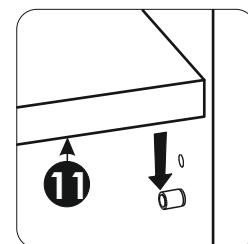
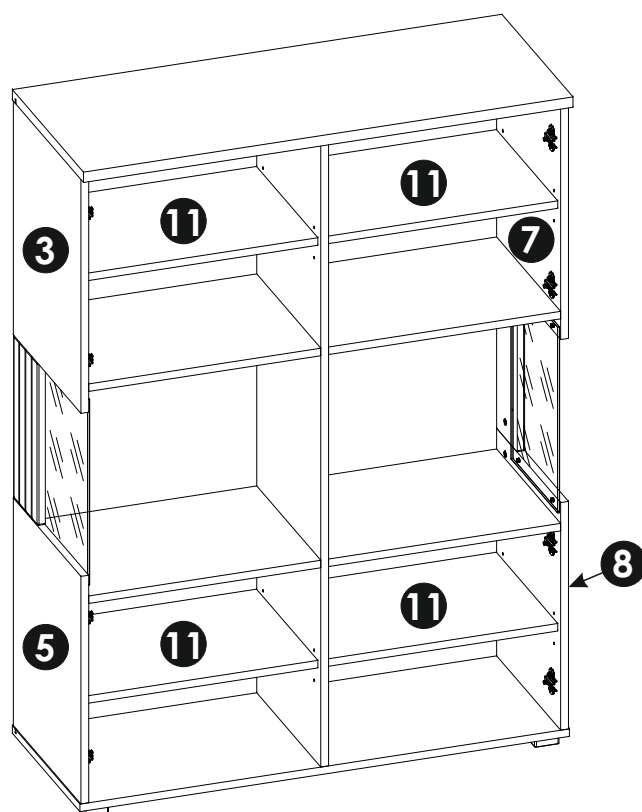

29 ▶

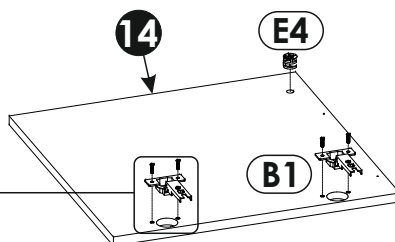
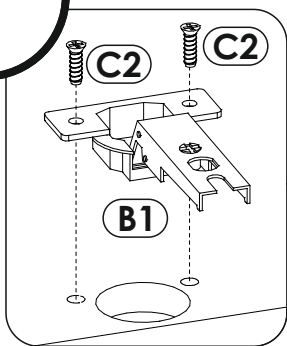
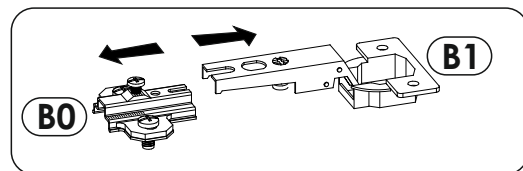
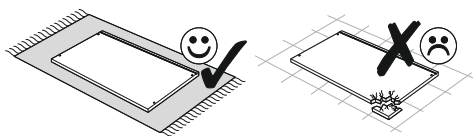

30 ▶

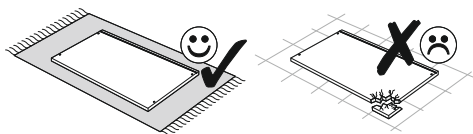

x2

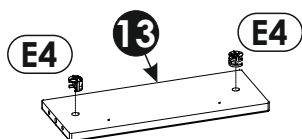

31 ▶▶

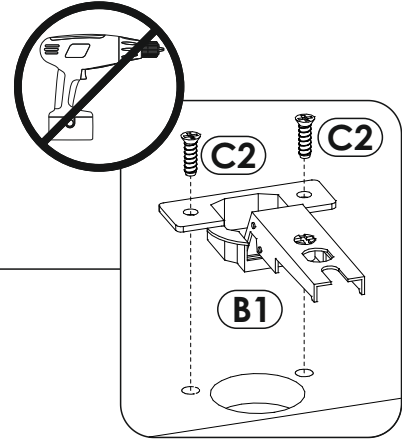
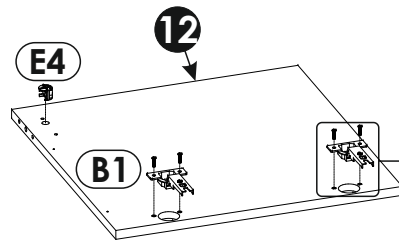
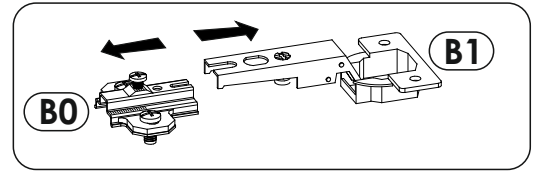
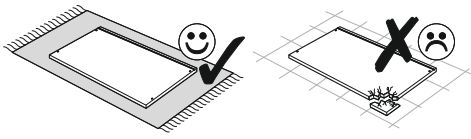

32 ▶▶

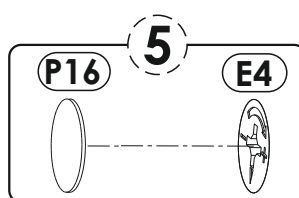
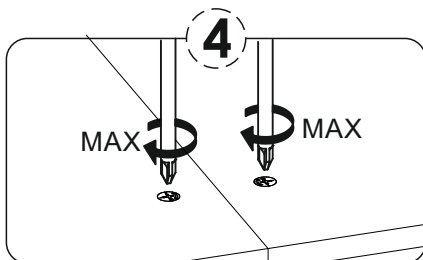
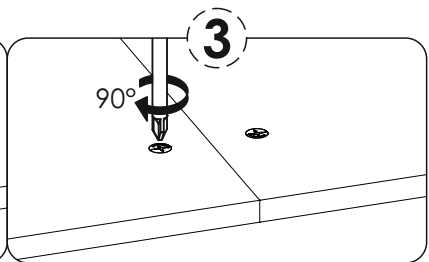
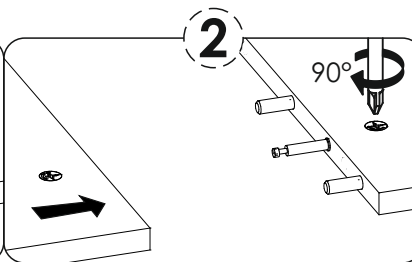
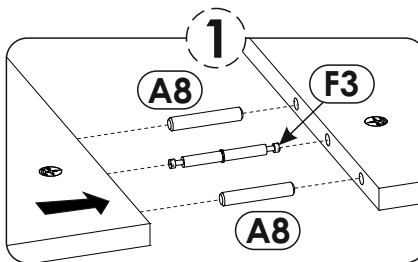
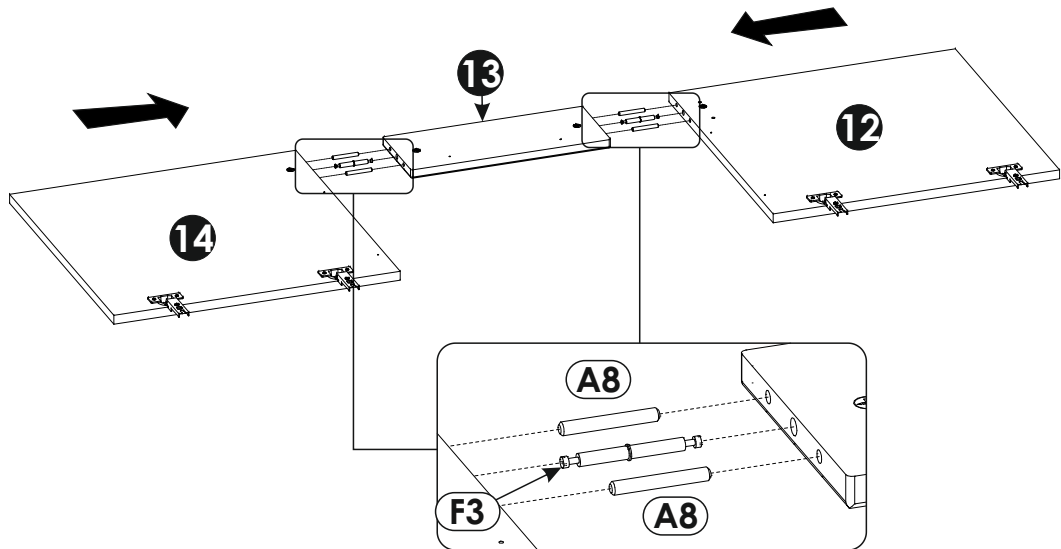
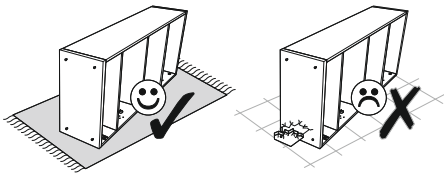

33 ▶

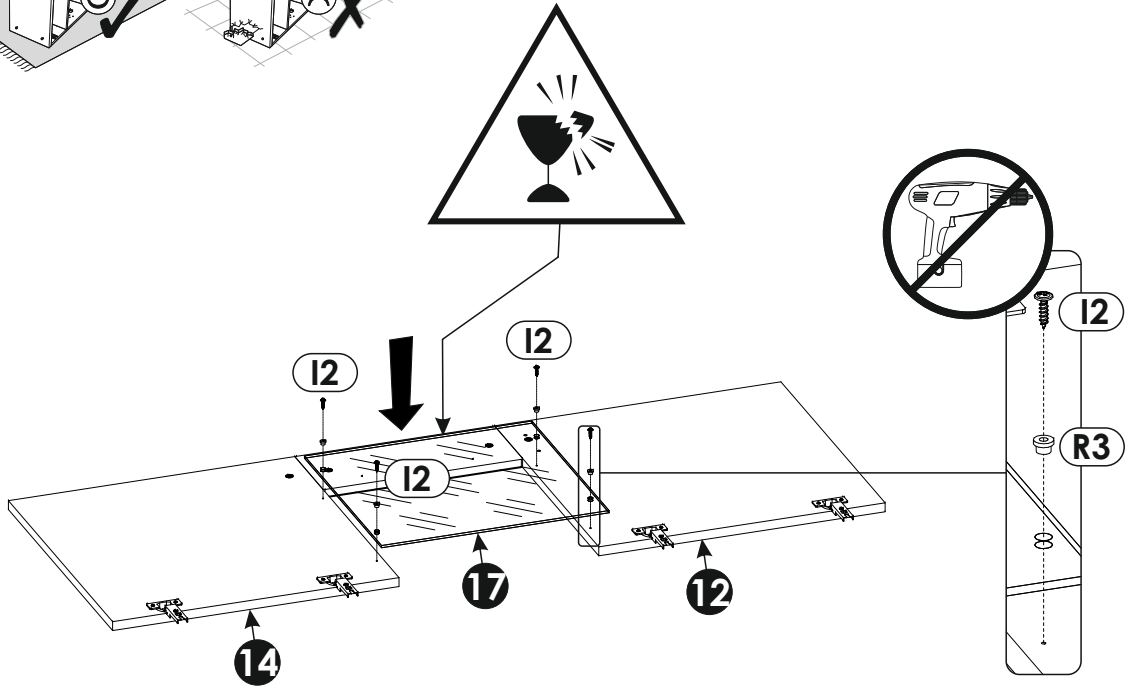
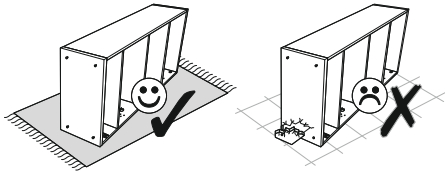

34 ▶

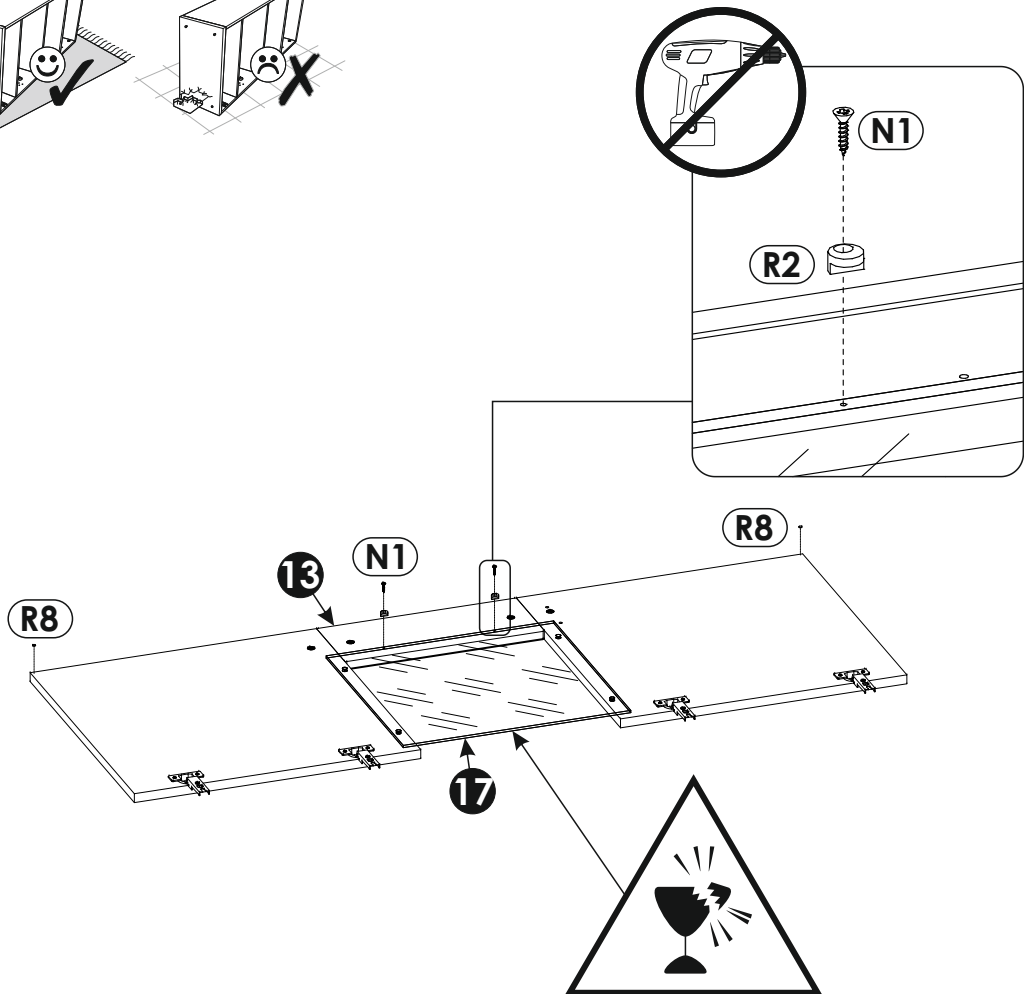
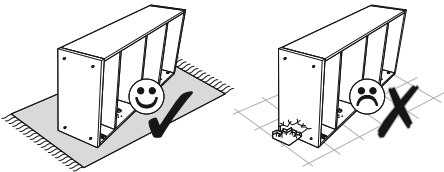

35 ▶

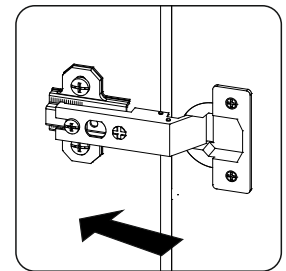
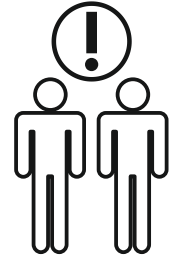
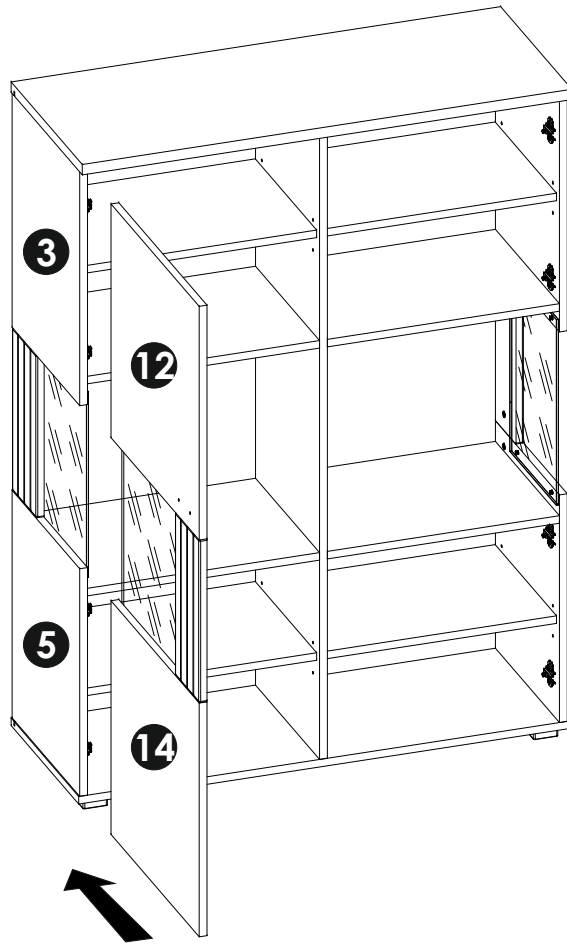

36 ▶

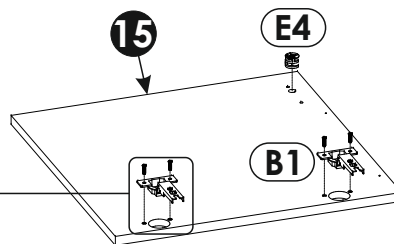
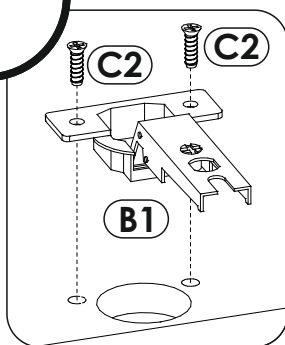
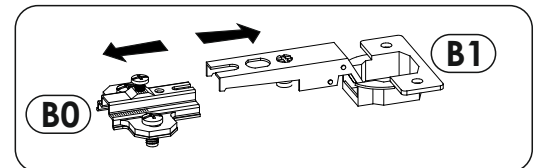
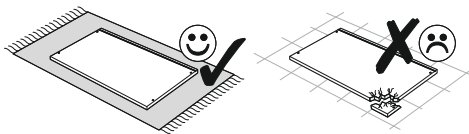

37▶

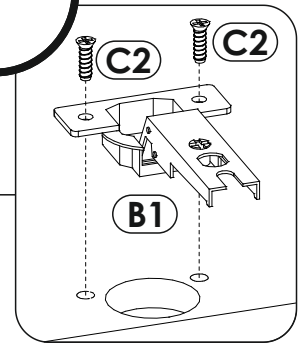
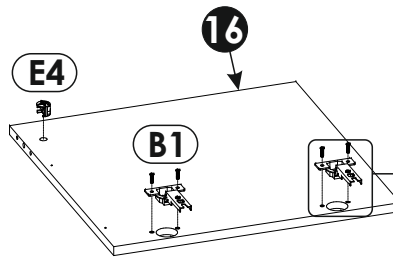
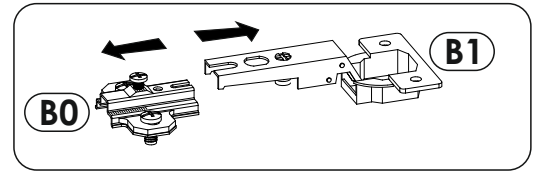
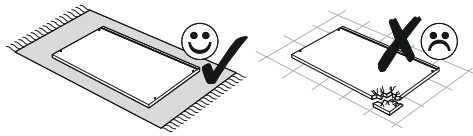

38▶

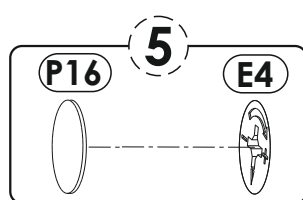
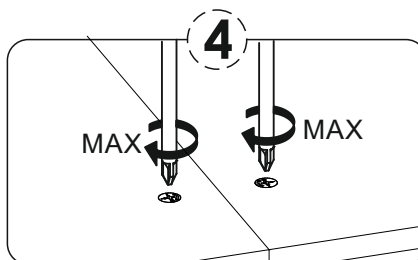
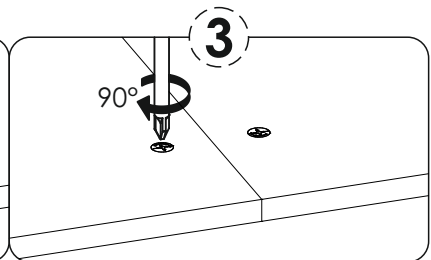
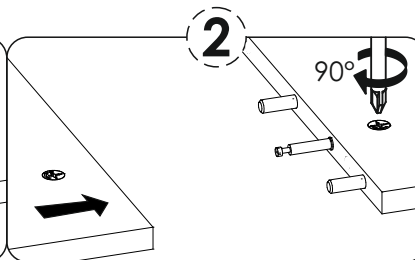
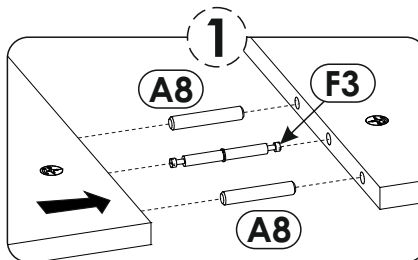
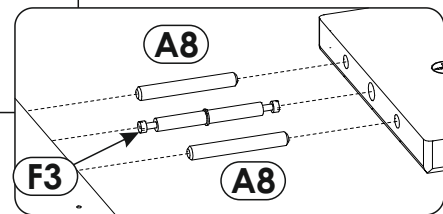
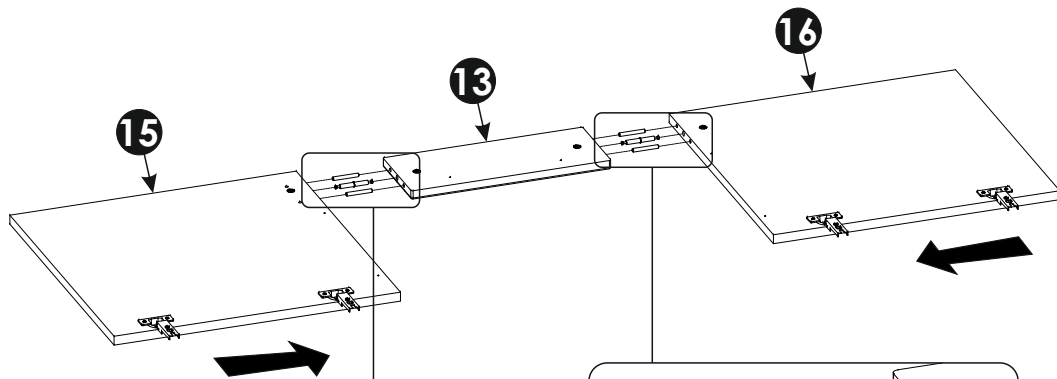
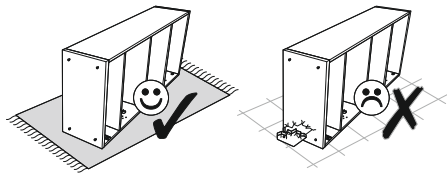

39 ▶

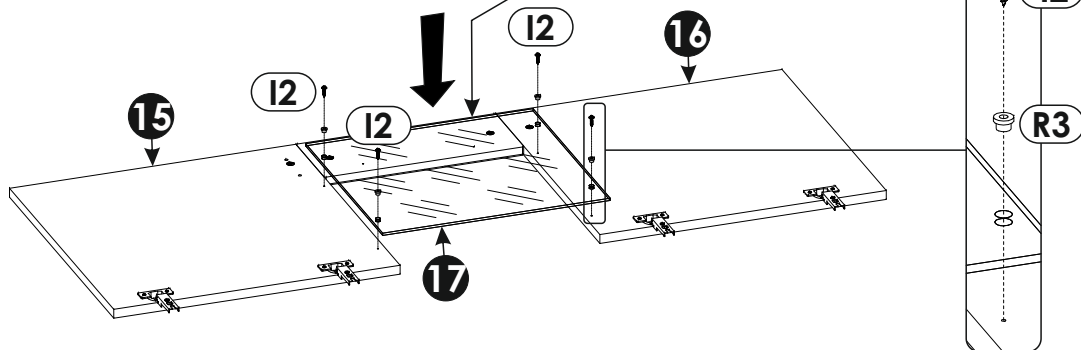
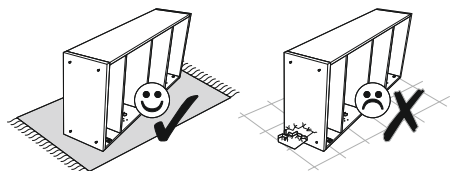

40 ▶

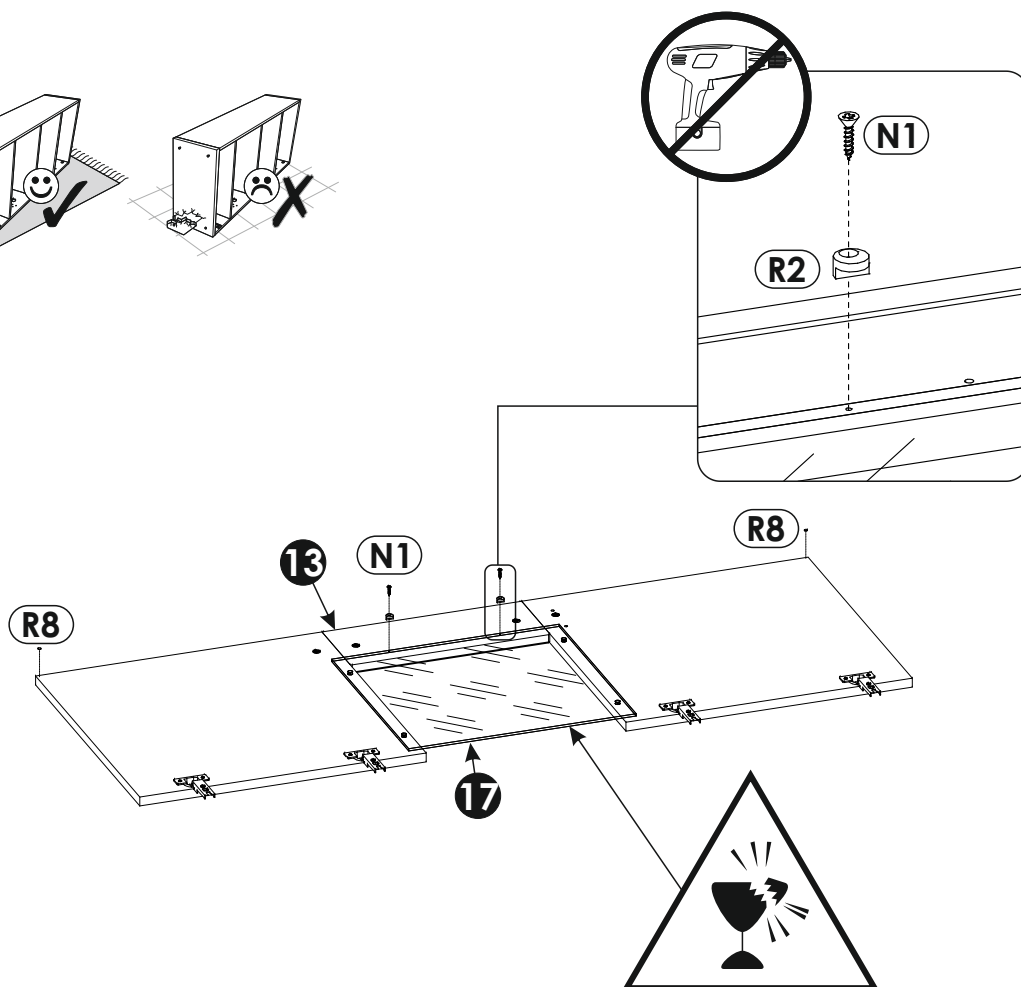
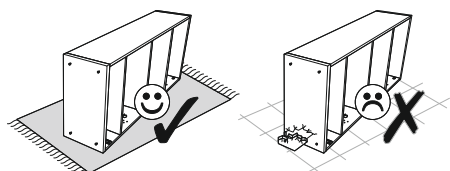

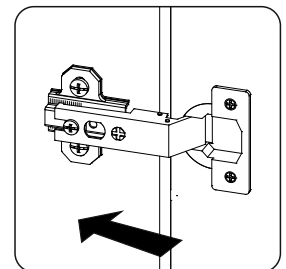
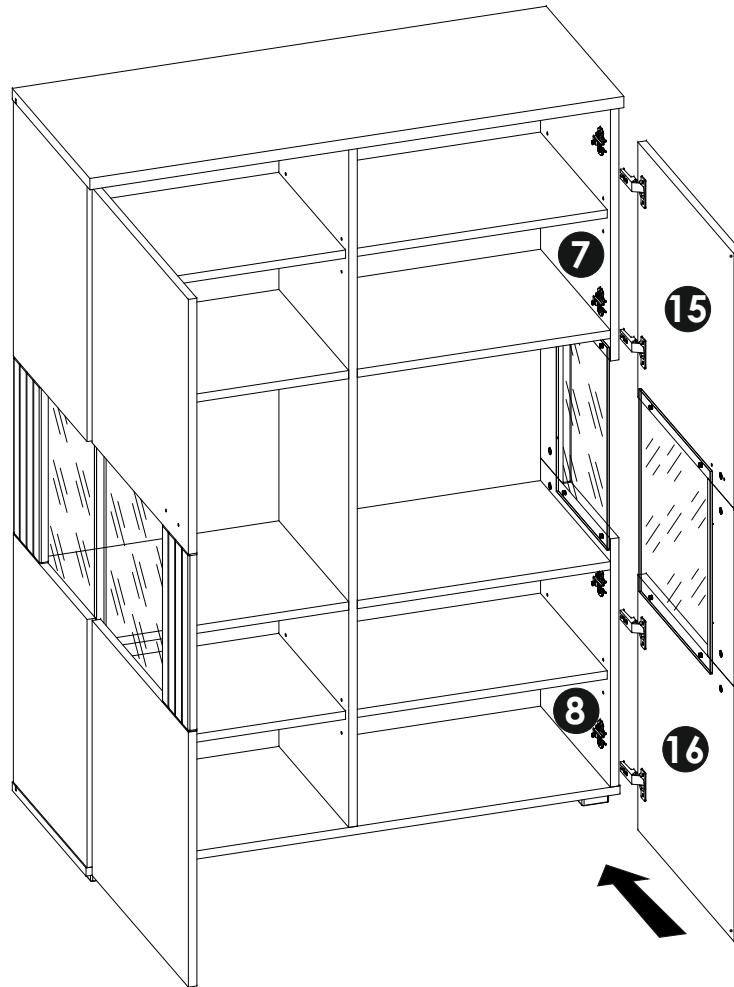
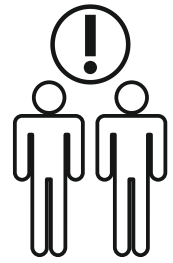

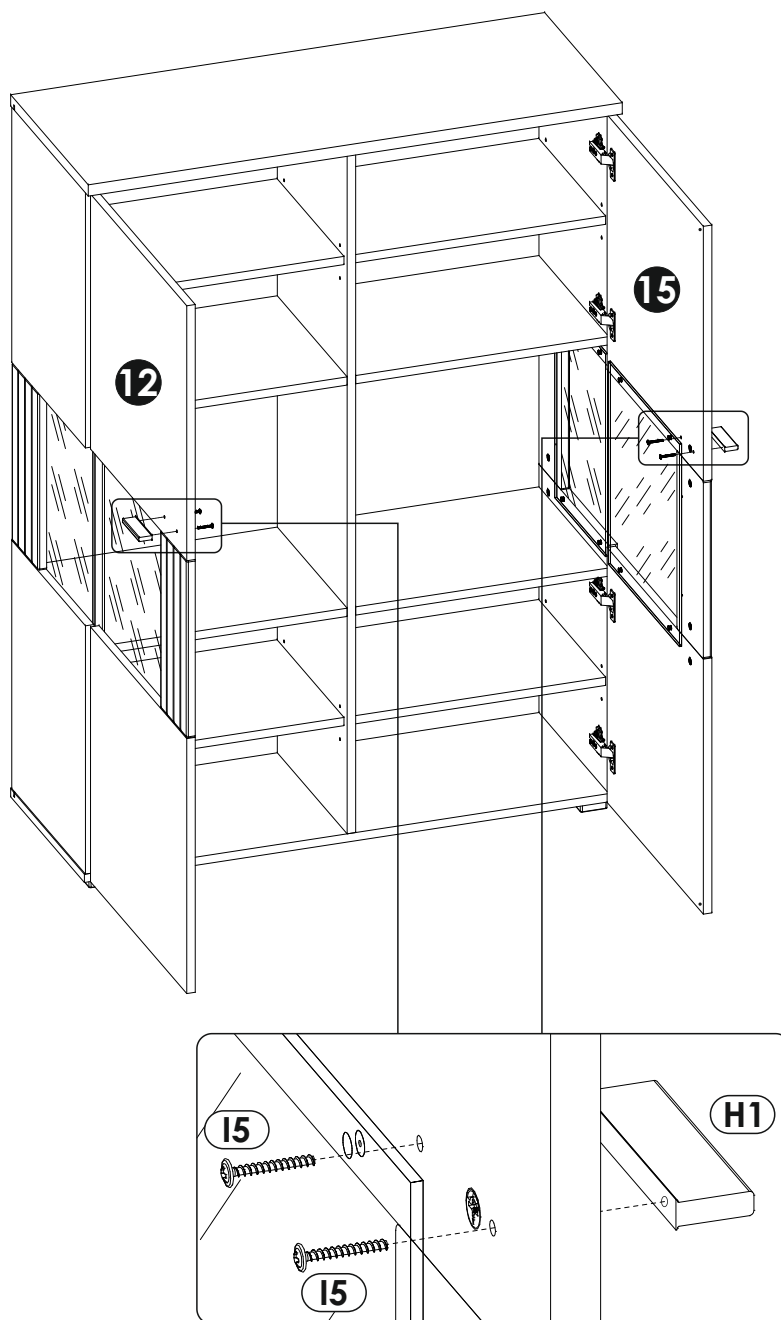

43 ▶

