

L [mm]	1370
d [mm]	660 "60"
$L_{0\text{max}}$ [mm]	600

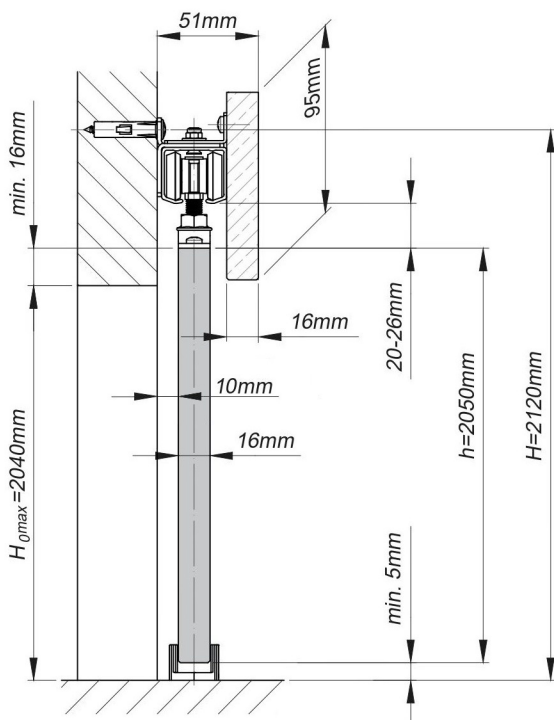

<i>L</i> [mm]	2000
<i>d</i> [mm]	760 "70"
<i>L_{0max}</i> [mm]	700

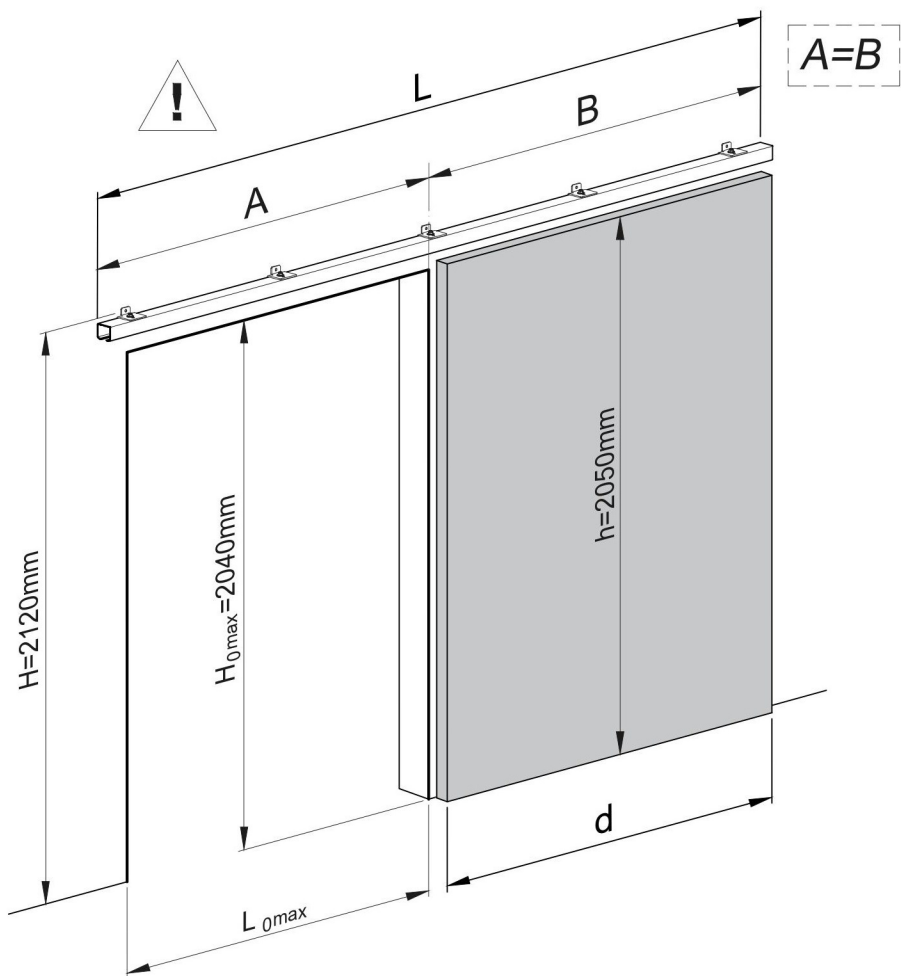
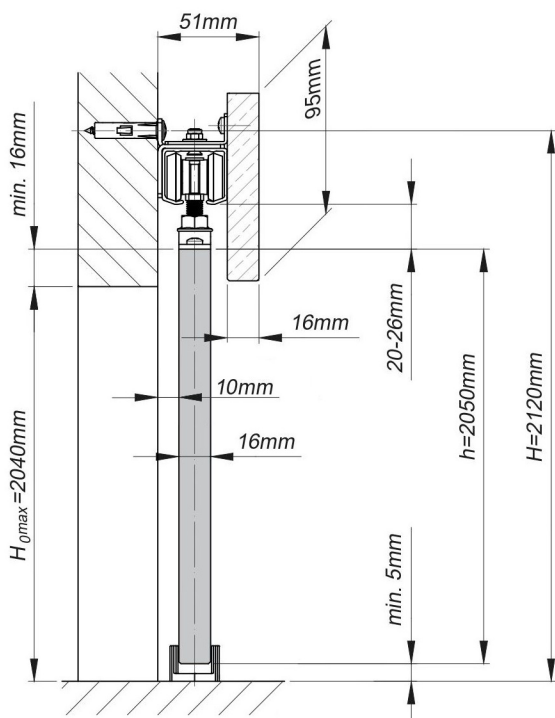
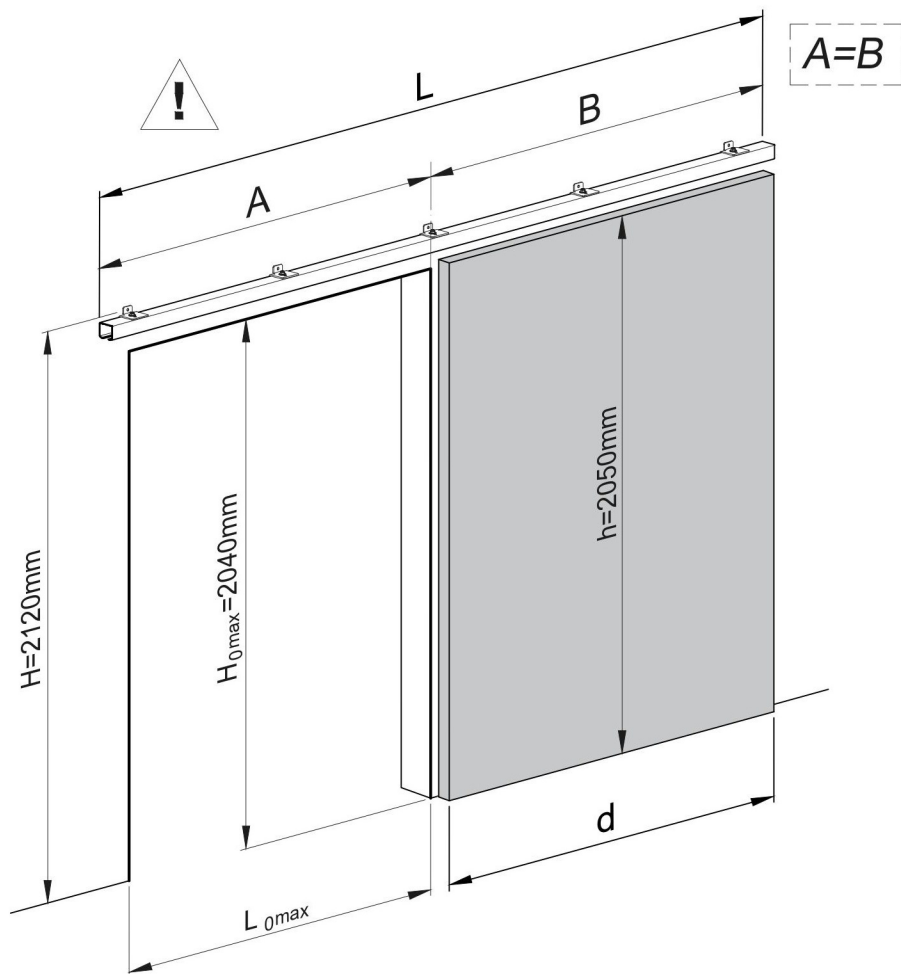

L [mm]	2000
d [mm]	860 "80"
$L_{0\text{max}}$ [mm]	800

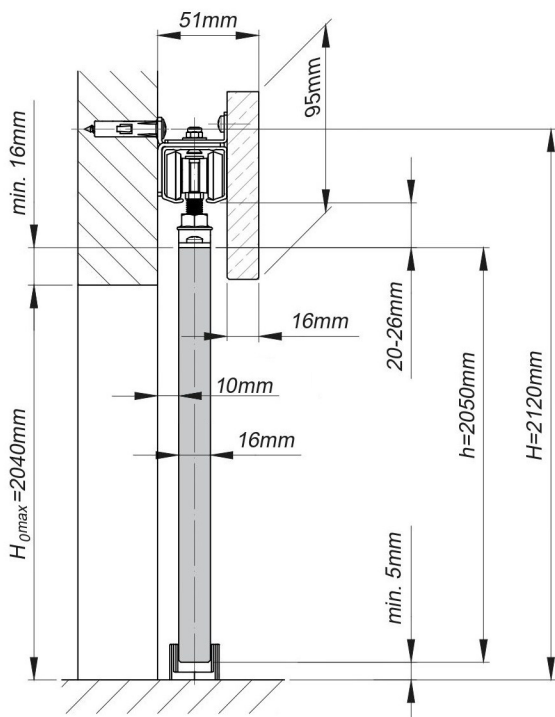
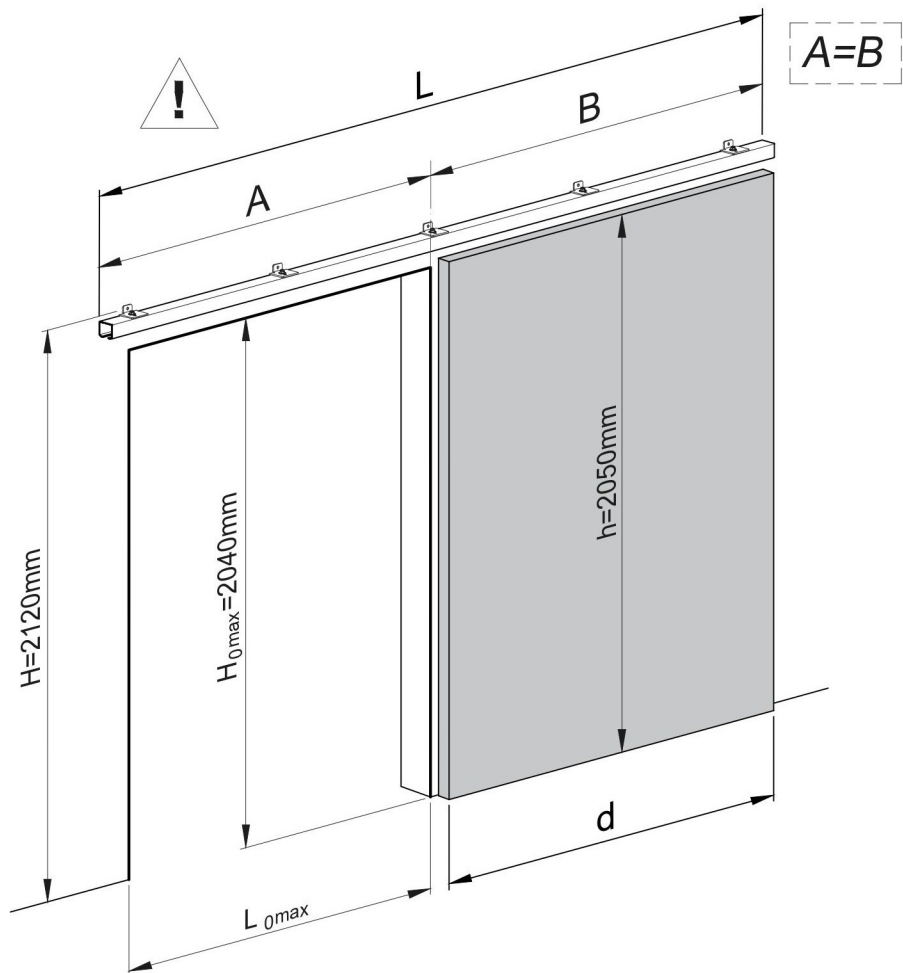

L [mm]	2000
d [mm]	960 "90"
$L_{0\text{max}}$ [mm]	900

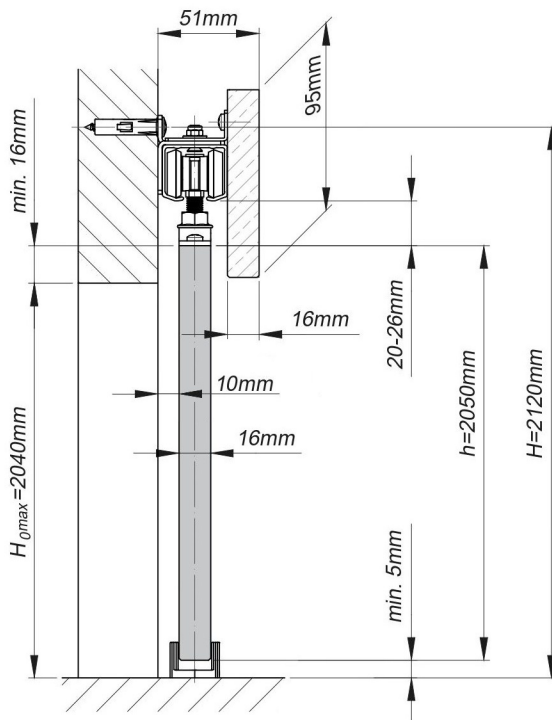
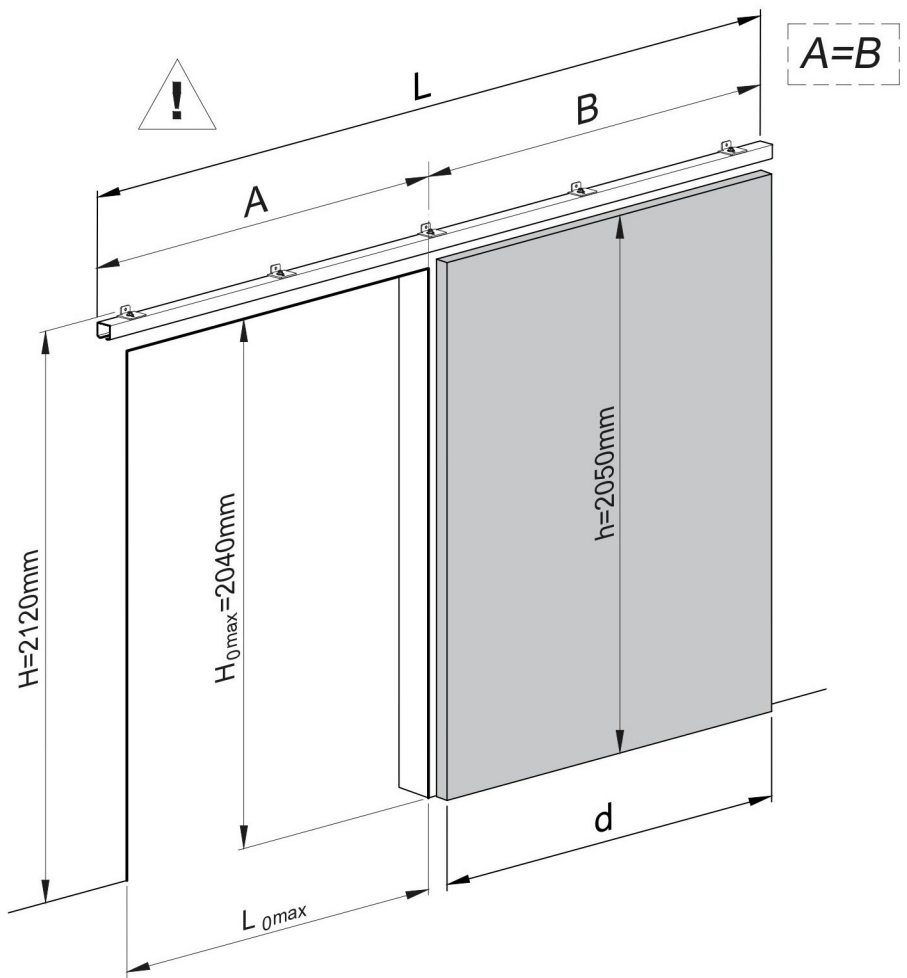

L [mm]	2000
d [mm]	1060 "100"
$L_{0\text{max}}$ [mm]	1000