

$\text{H}10 \times 50 \text{mm}$	$\text{H}5.0 \times 70 \text{mm}$	$\text{H}20$
O7	P29	E11
2	2	2

$\text{H}8 \times 30 \text{mm}$	$6.4 \times 50 \text{mm}$	$\text{H}5/18 \text{mm}$	L=20mm		$60 \times 40 \times 20$	$\text{H}4.0 \times 25 \text{mm}$	
A	B	C6	D2	E	F1	P14	O
20	24	10	10	10	4	8	1

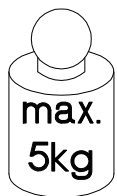

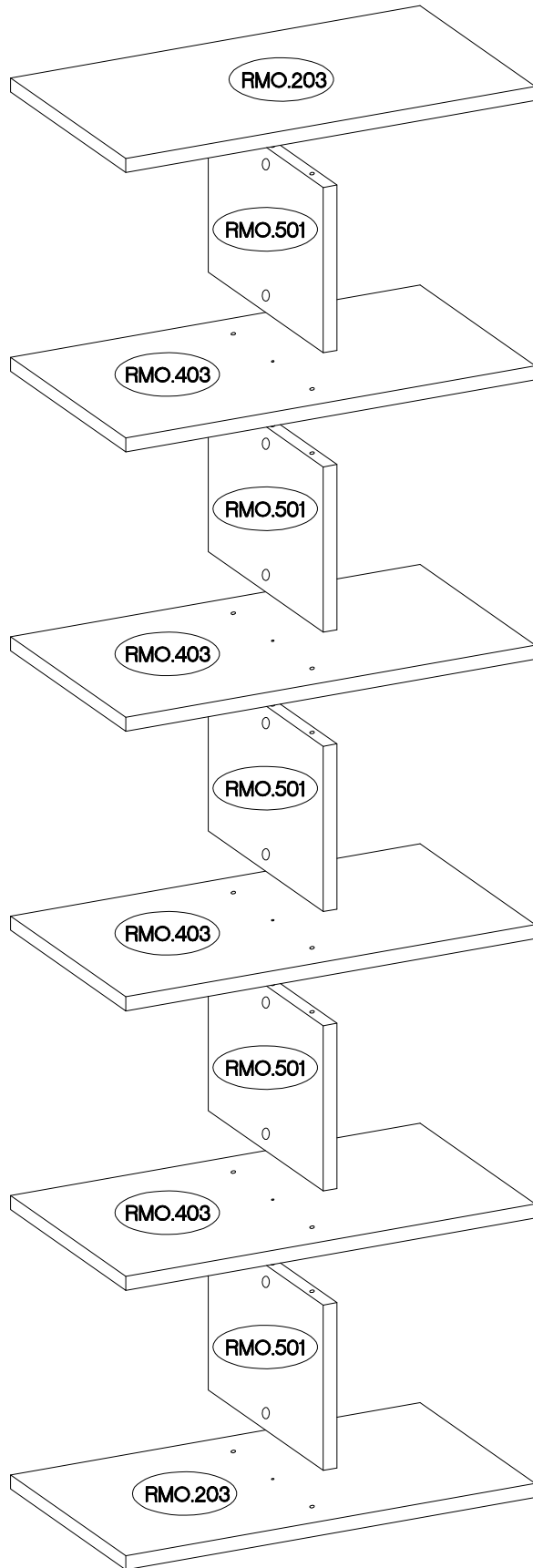

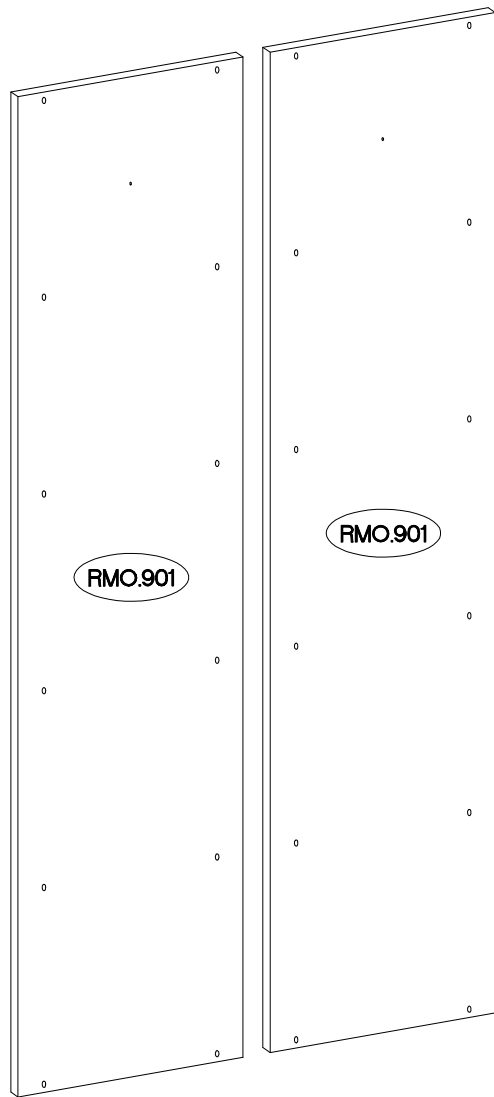

MSN.203

MSN.403

1/2	RMO.203	830x281x28
	RMO.403 x 4	830x281x28
	RMO.501 x 2	330x280x28
2/2	RMO.203	830x281x28
	RMO.501 x 3	330x280x28
	RMO.901 x 2	1820x416x16

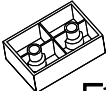
1

+8x30mm  A	+15/18mm  C6	L=20mm  D2	60x40x20  F1	+4.0x25mm  P14
20	10	10	4	8

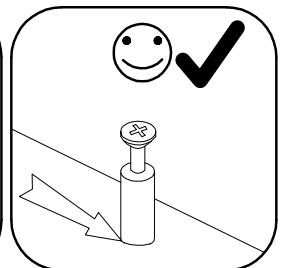
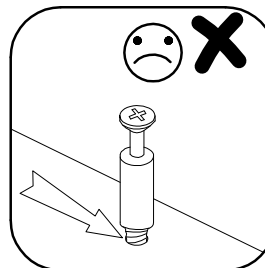
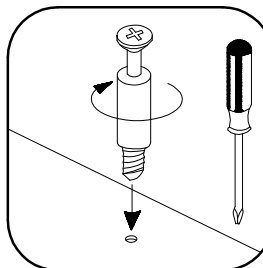
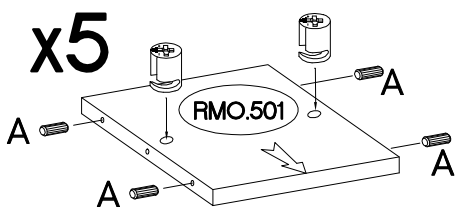
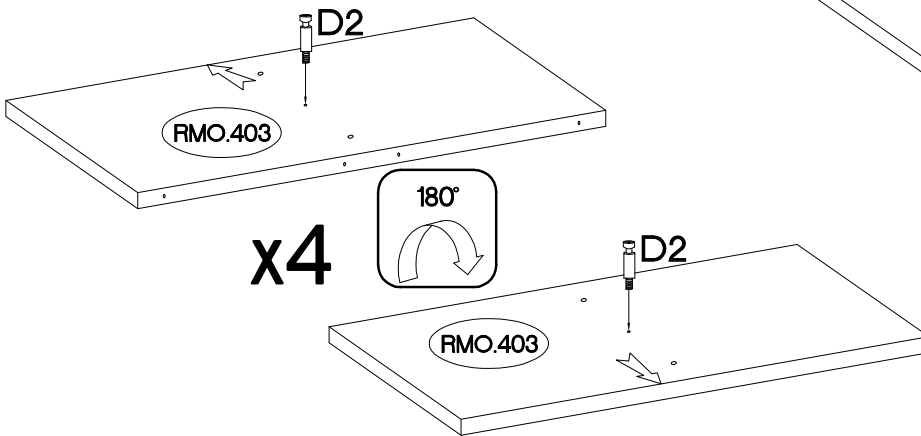
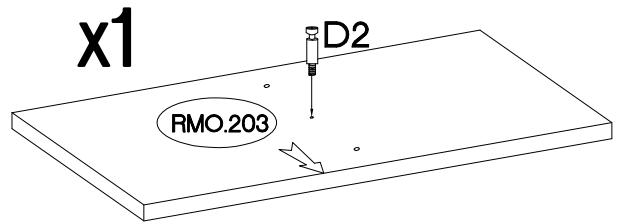
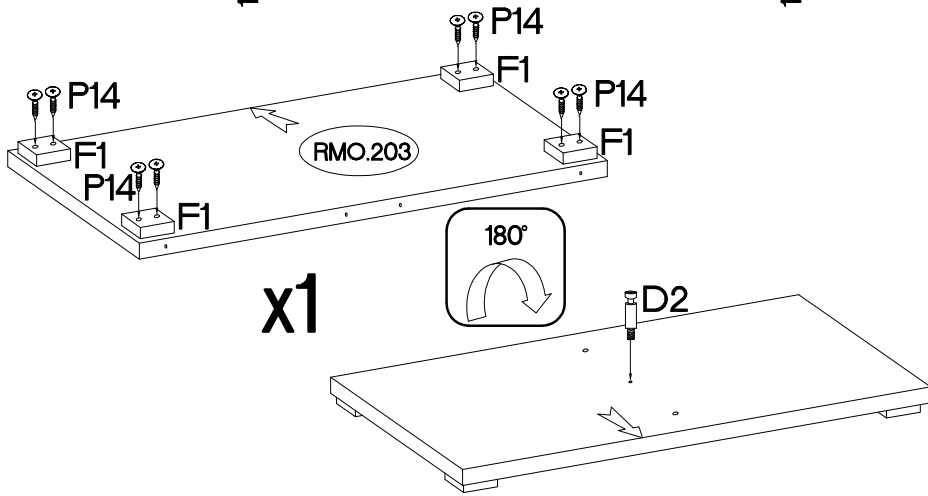
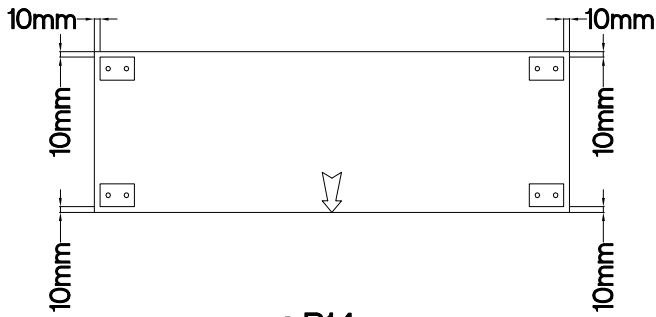
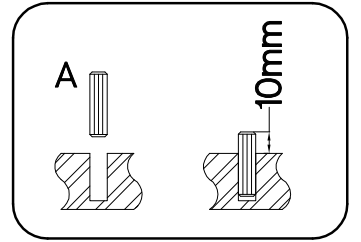
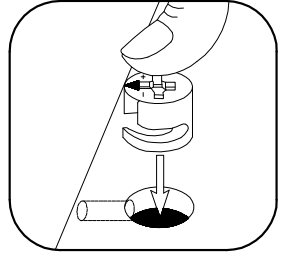
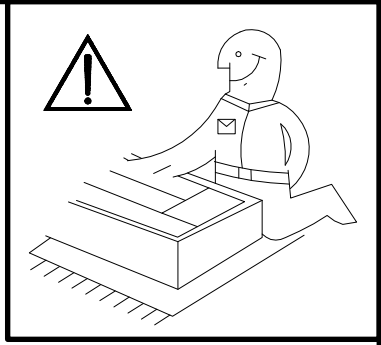

2

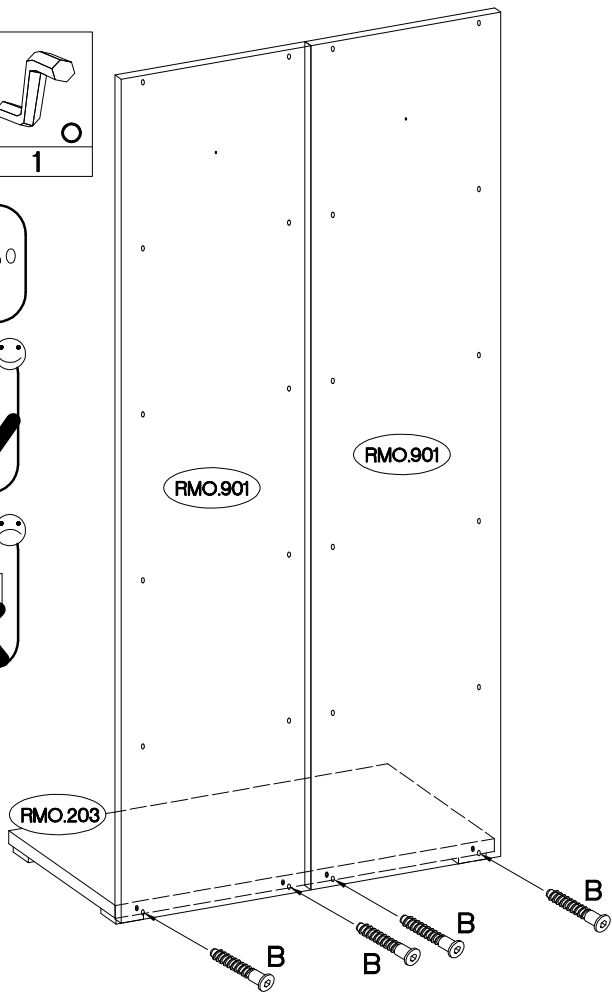
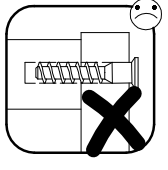
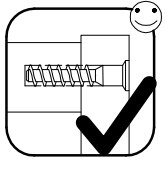
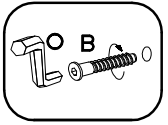
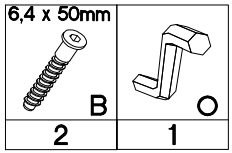

3

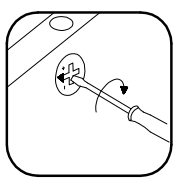
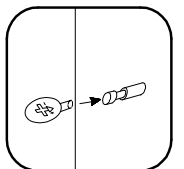
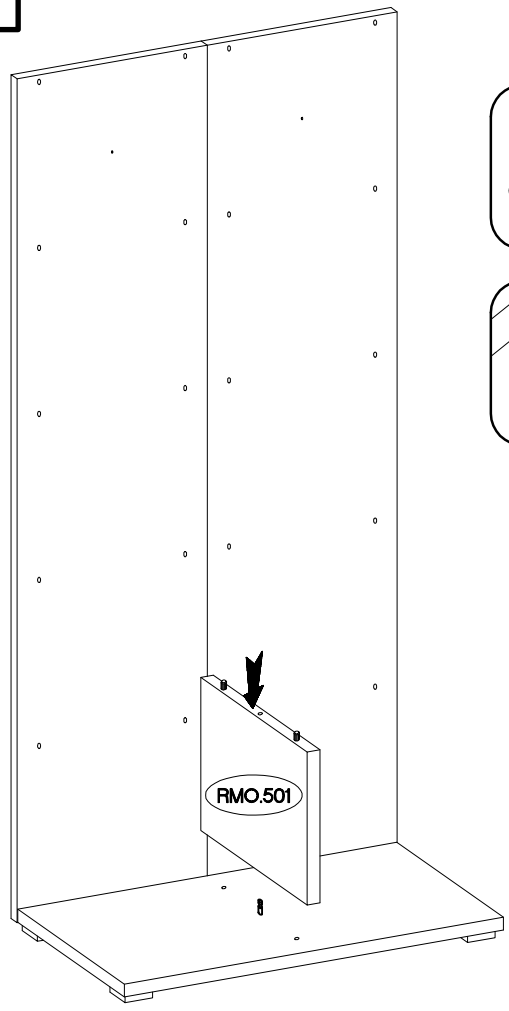

4

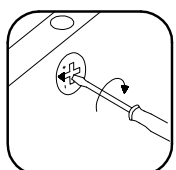
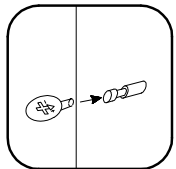
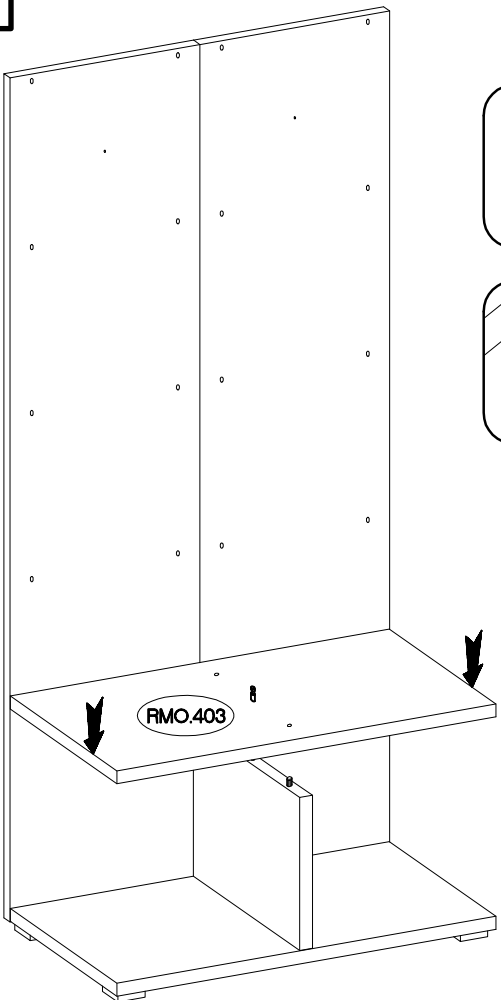

5

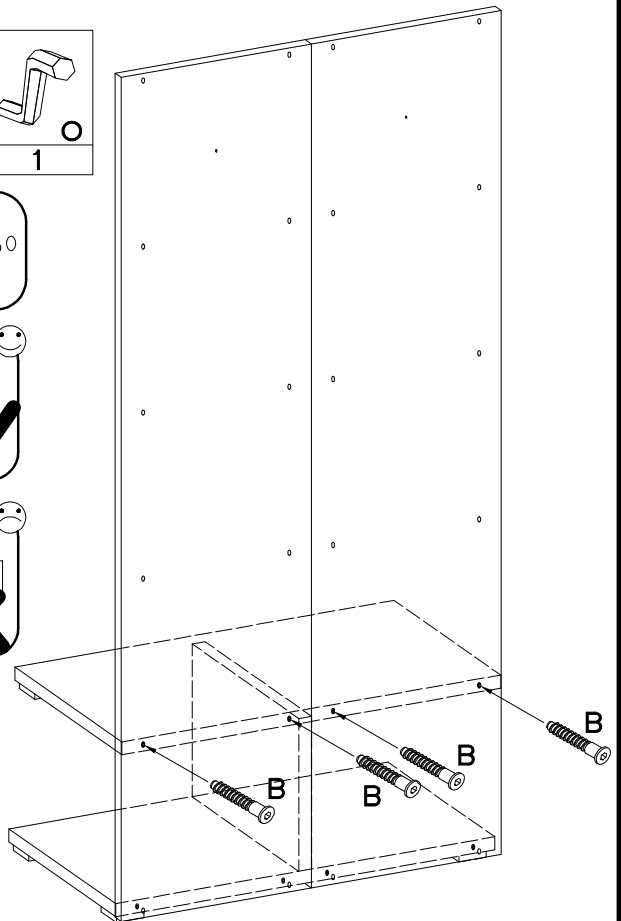
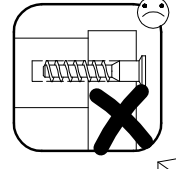
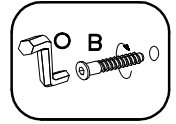
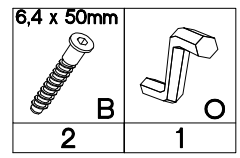

6

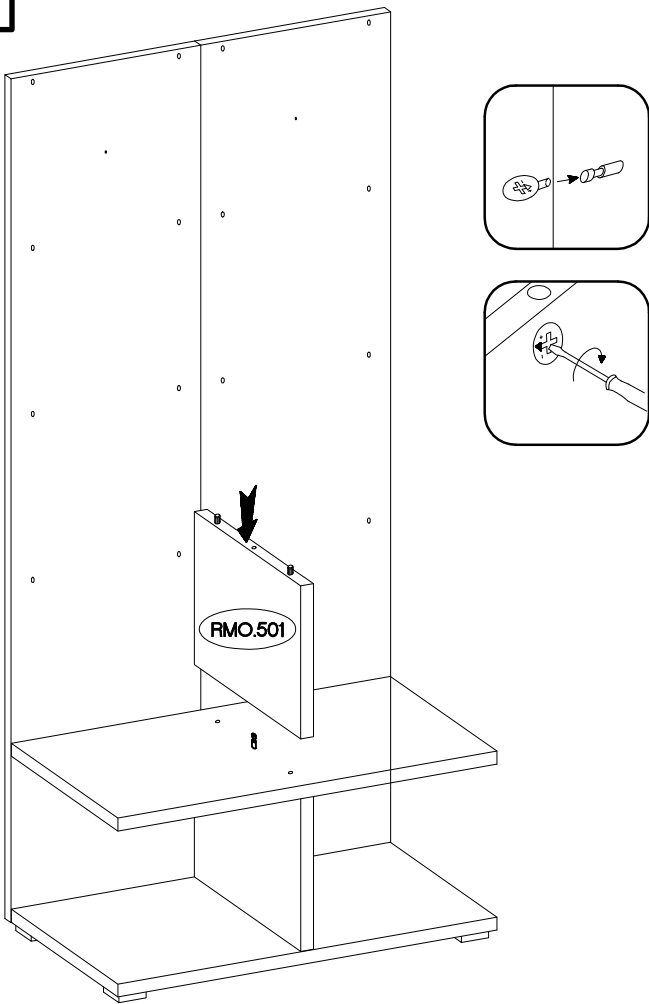

7

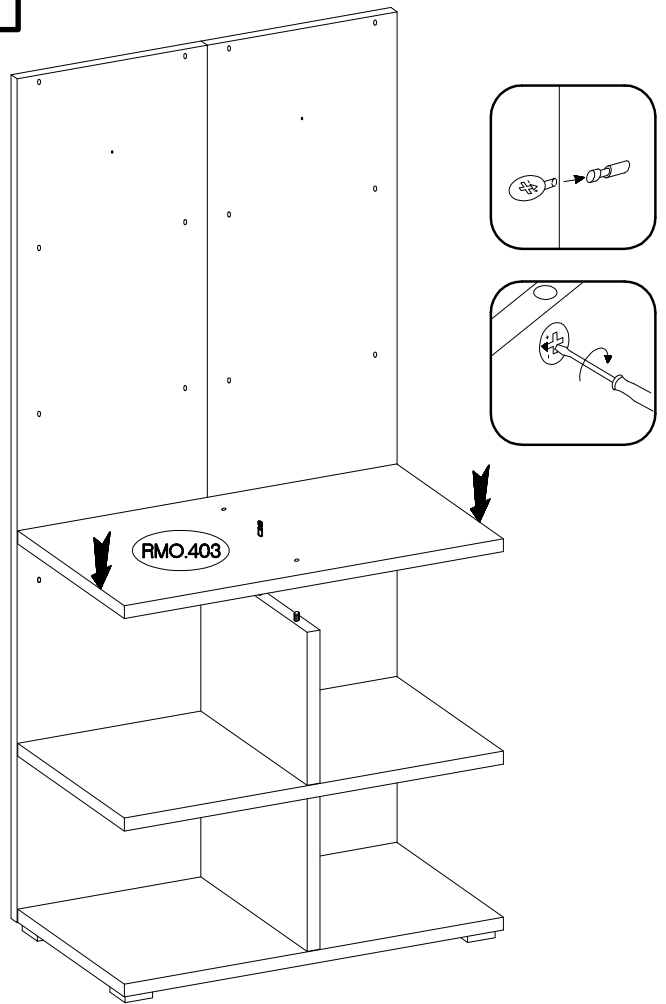

8

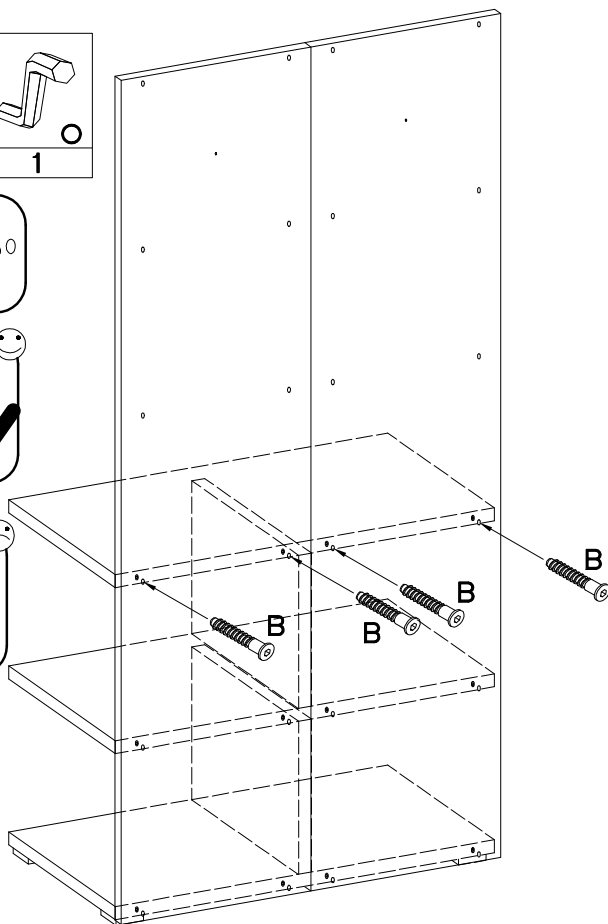
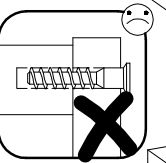
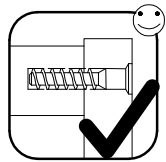
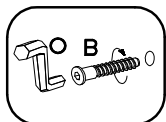
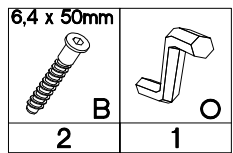

9

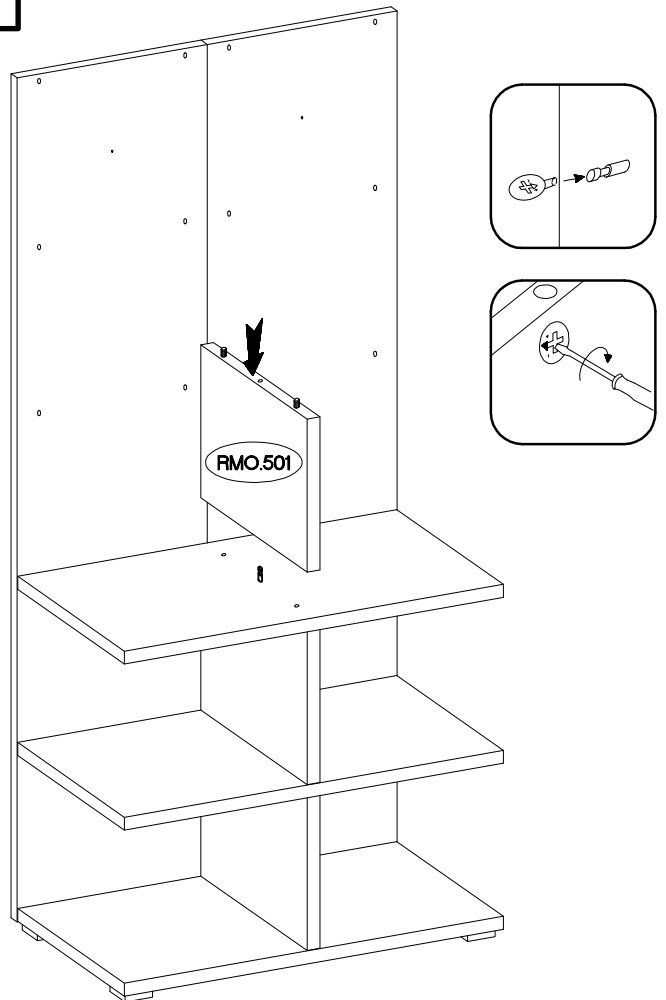

10

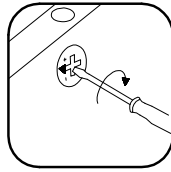
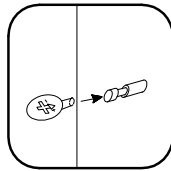
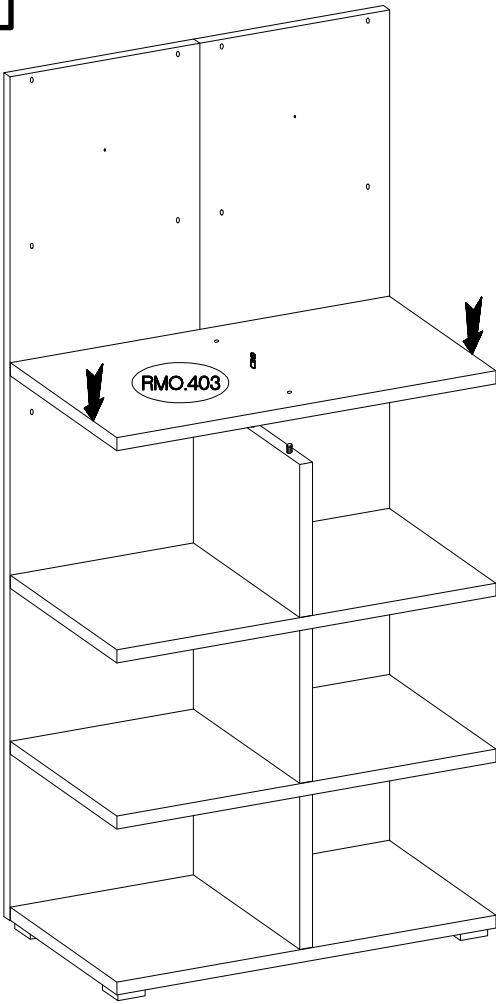

11

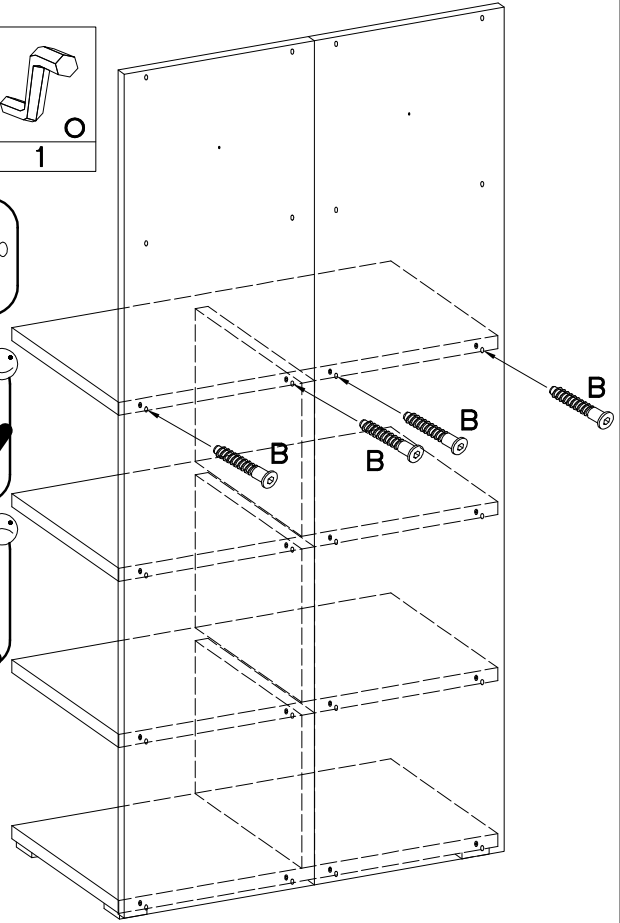
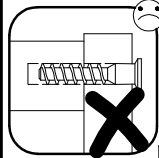
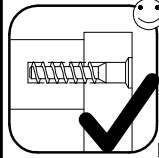
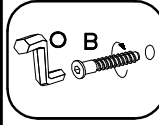
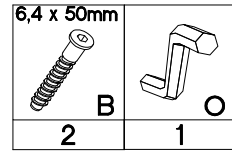

12

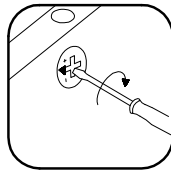
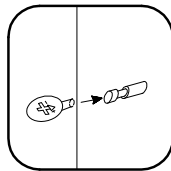
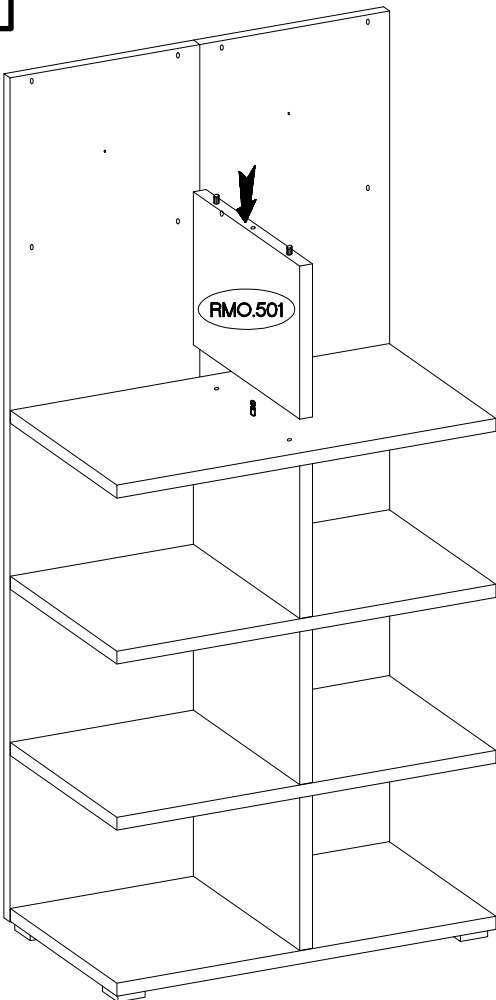

13

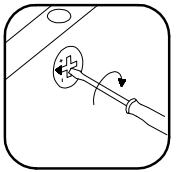
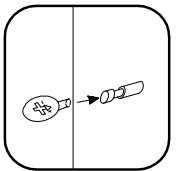
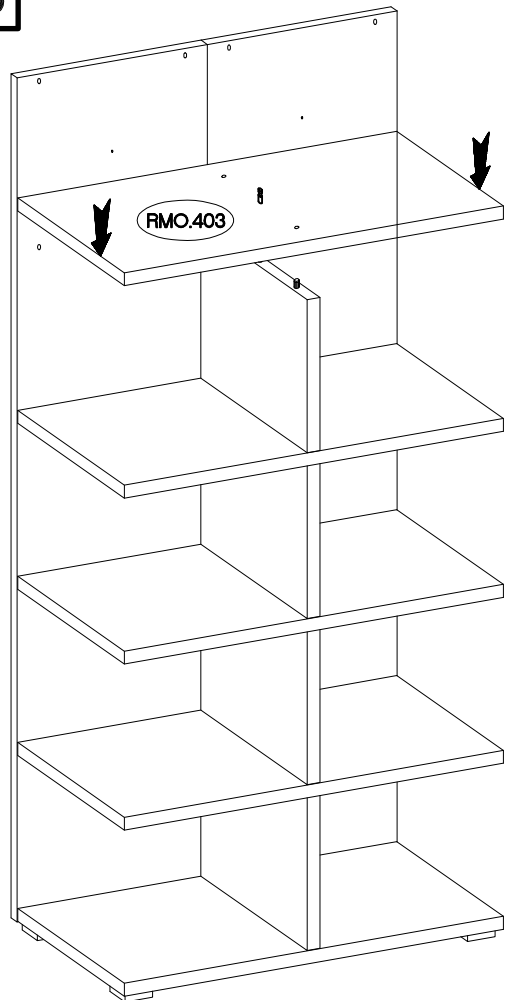

14

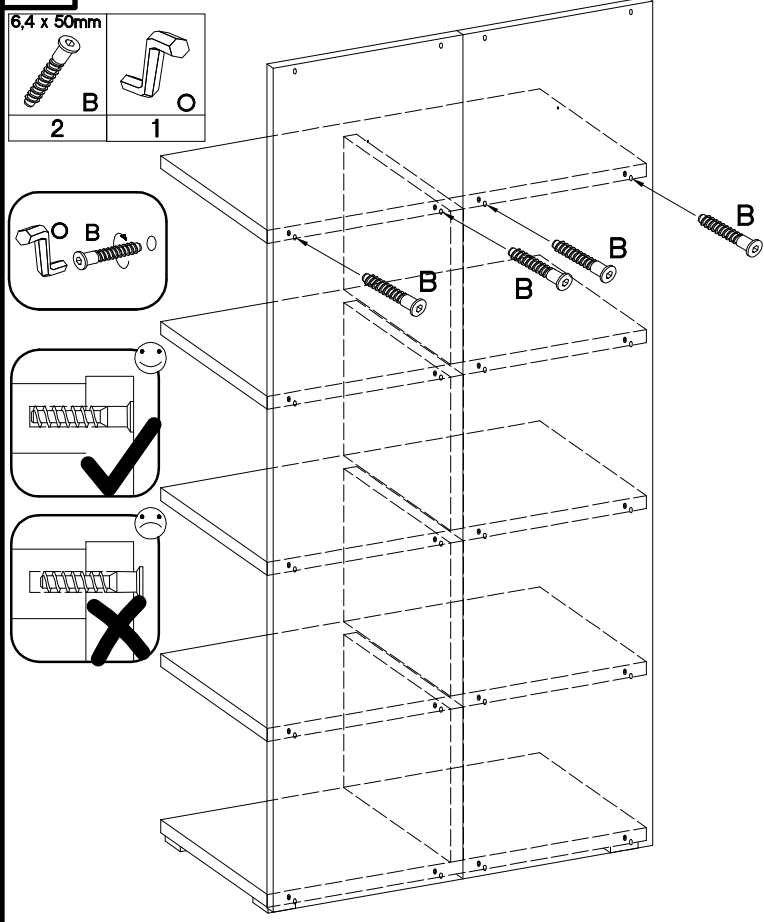

15

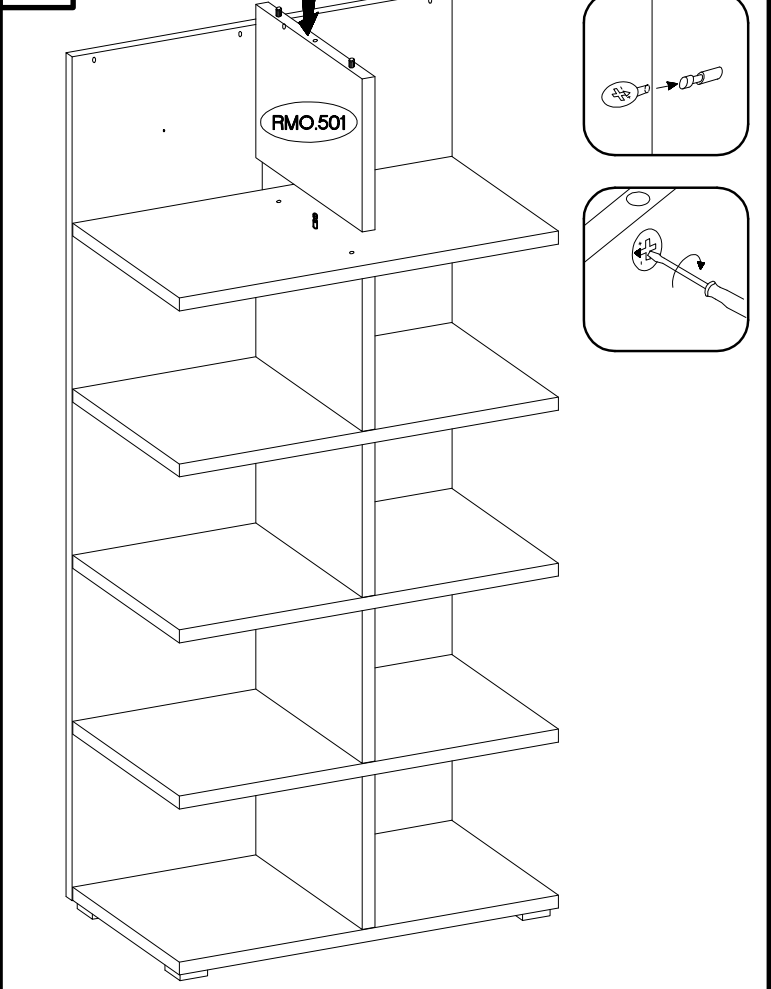

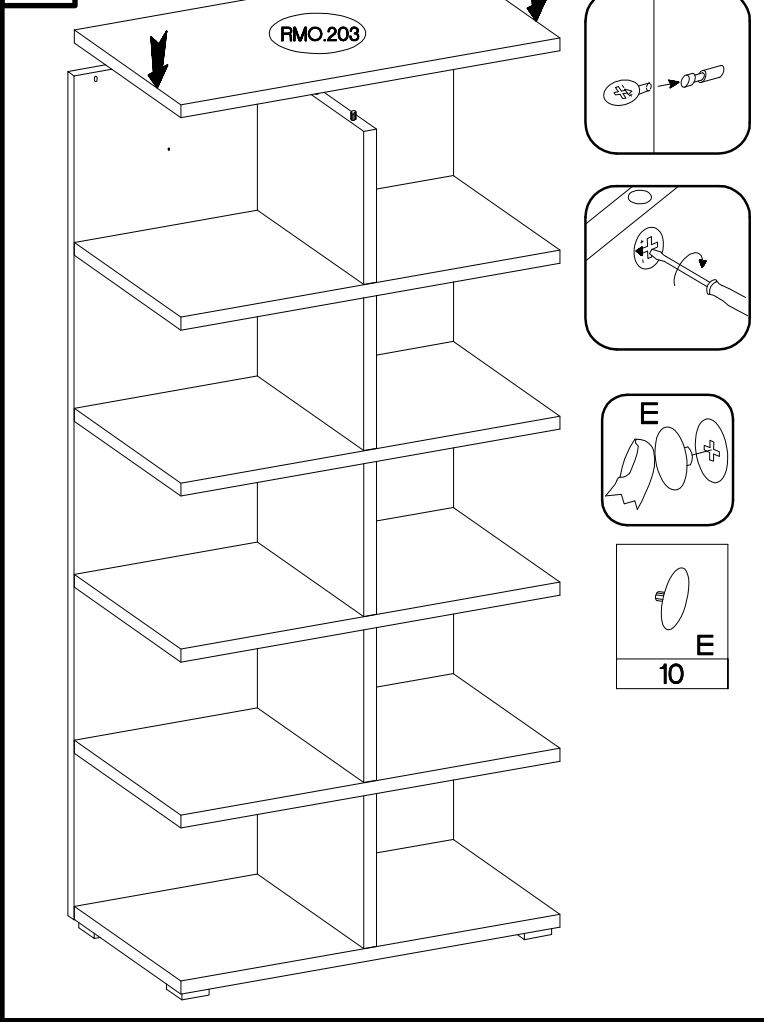

16

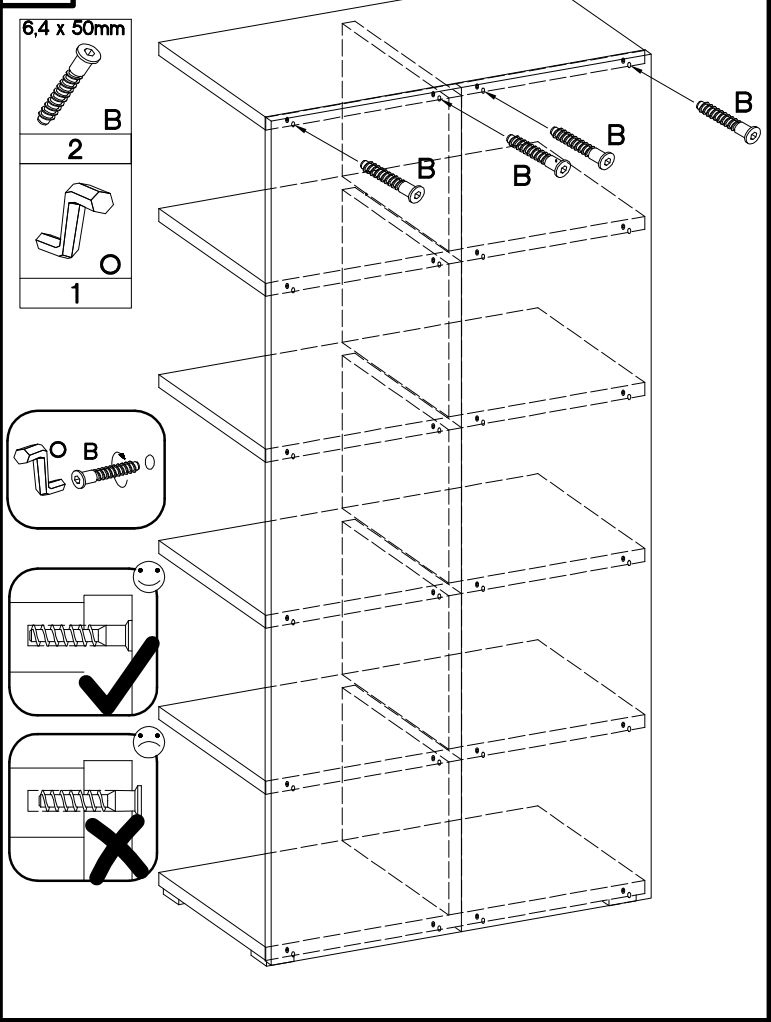

17



 $\varnothing 10 \times 50 \text{mm}$	 $\varnothing 5.0 \times 70 \text{mm}$	 $\varnothing 20$
O7 2	P29 2	E11 2

