

1

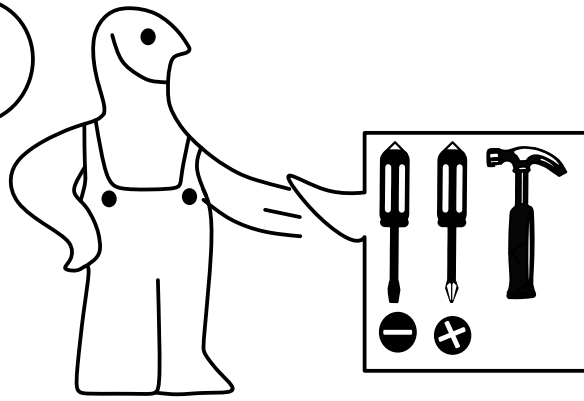

2

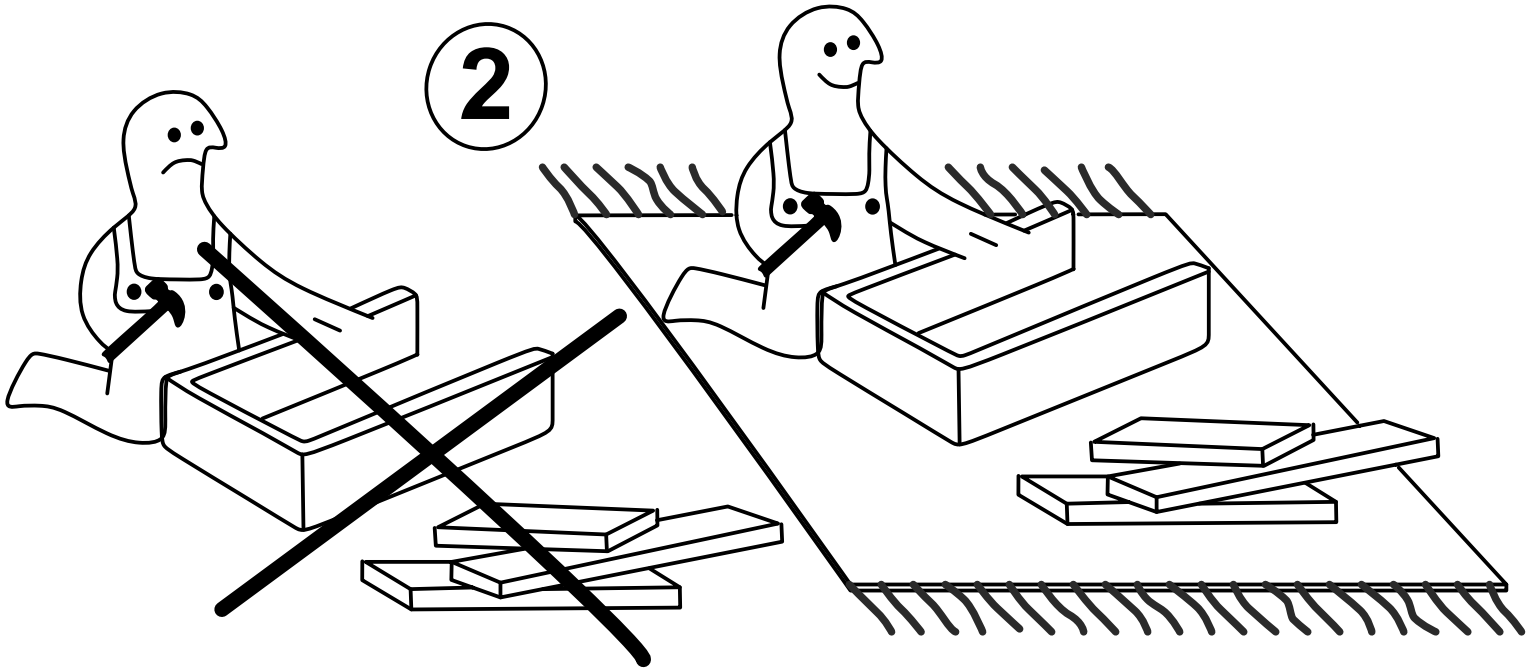

3

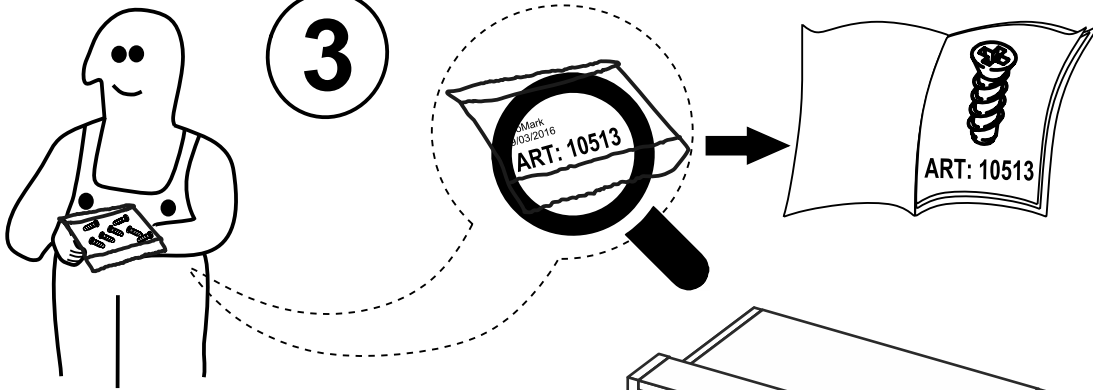

4

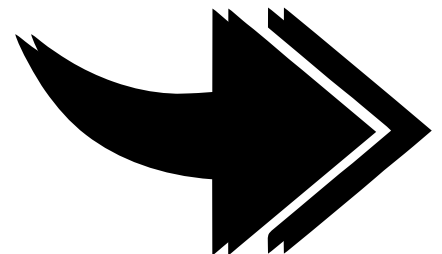
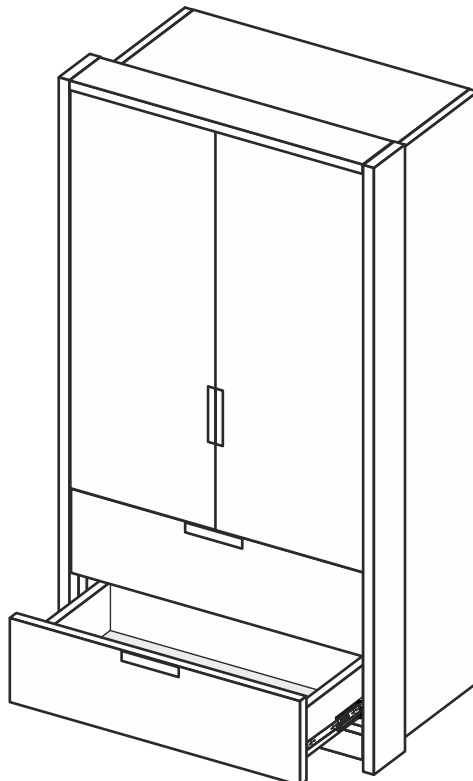
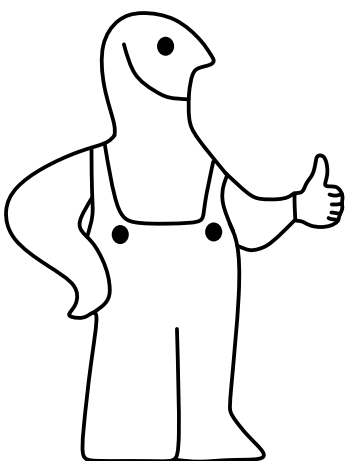

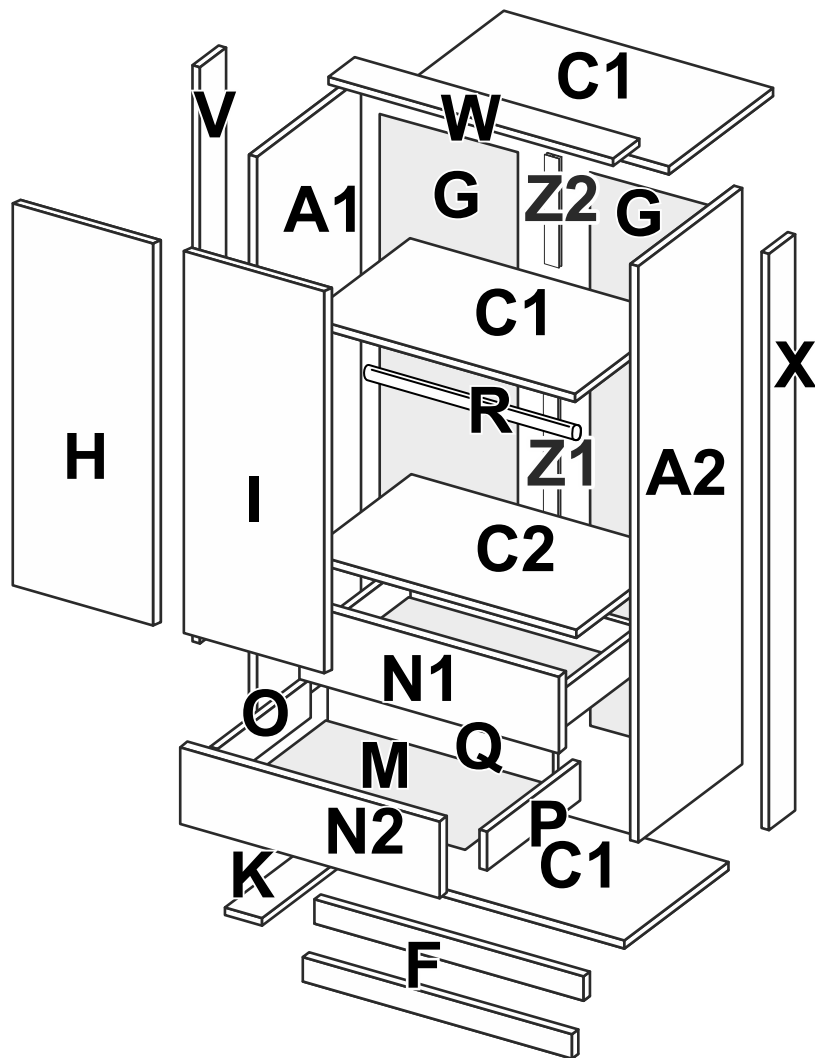

- A1-** 2104 x 530 x16- x 1
- A2-** 2104 x 530 x16- x 1
- C1-** 864 x 516 x16- x 3
- C2-** 864 x 514 x16- x 1
- F -** 864 x 50 x16- x 2
- G -** 2054 x 438 x 3 - x 2
- H -** 1550 x 444 x16- x 1
- I -** 1550 x 444 x16- x 1
- K -** 434 x 80 x16- x 2
- M-** 818 x 446 x 3 - x 2
- N1-** 892 x 246 x16- x 1
- N2-** 892 x 246 x16- x 1
- O -** 450 x 136 x16- x 2
- P -** 450 x 136 x16- x 2
- Q -** 806 x 136 x16- x 2
- R -** 857 - x 1
- Z1-**1606MM - x 1
- Z2-**394MM - x 1
- V -** 2132x110x 28 - x 1
- W-** 897x110 x 28 - x 1
- X -** 2132x110x 28 - x 1

