



















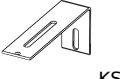



24	24	28	14	7	6
					
B	A	8.0x35	D	PZ	T
					
X	S3	S4	3.5x16 W4	KS	Z
24	4	4	7	1	7

8	2	2	4	2	8
					
I	PTS	O	NP2	NP1	WS
					
6.3x13 F	G4	G3	G2	G	
16	6	16	4	12	



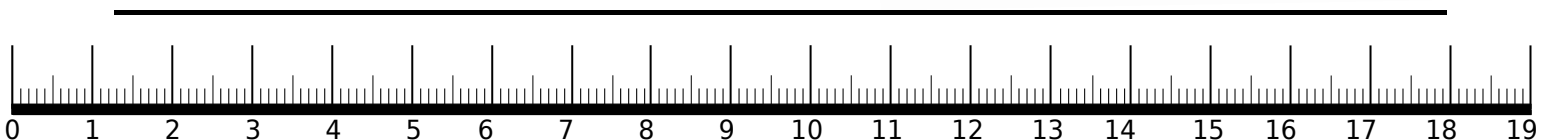
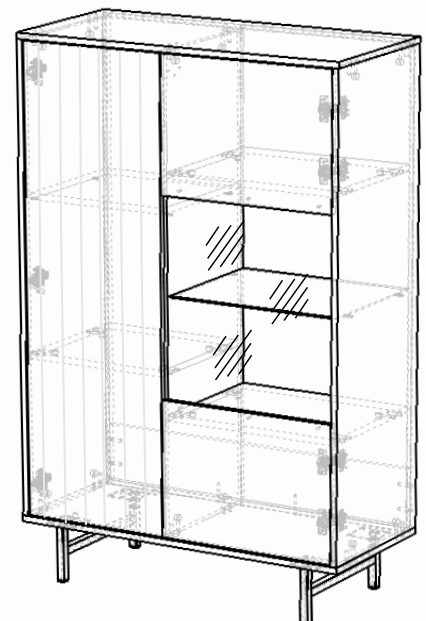
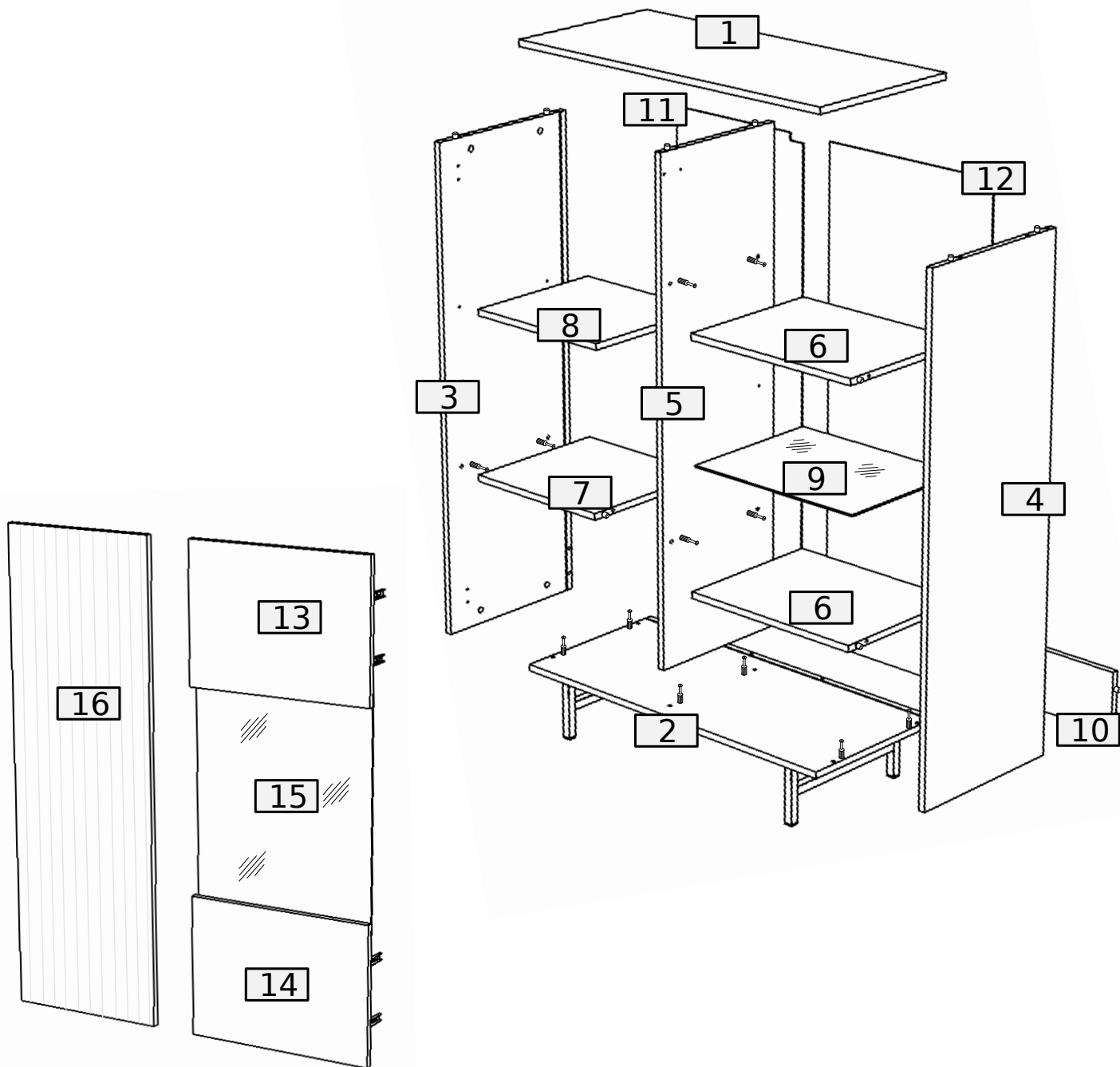

No.	Pcs.	L	W	D	Pac
1	1	900	410	16	2/2
2	1	900	410	16	2/2
3	1	1218	409	16	1/2
4	1	1218	409	16	1/2
5	1	1218	370	16	1/2
6	2	465	370	16	2/2
7	1	385	370	16	2/2
8	1	385	360	16	2/2
9	1	464	350	4	2/2
10	1	866	150	16	2/2
11	1	1232	399	3	1/2

No.	Pcs.	L	W	D	Pac
12	1	1232	479	3	1/2
13	1	470	350	16	2/2
14	1	470	350	16	2/2
15	1	572	460	4	2/2
16	1	1212	390	16	1/2



BOX 1/2

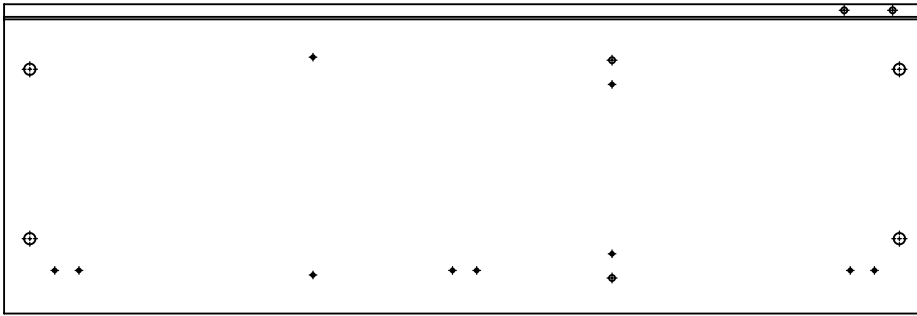

3. 1218x409x16 mm

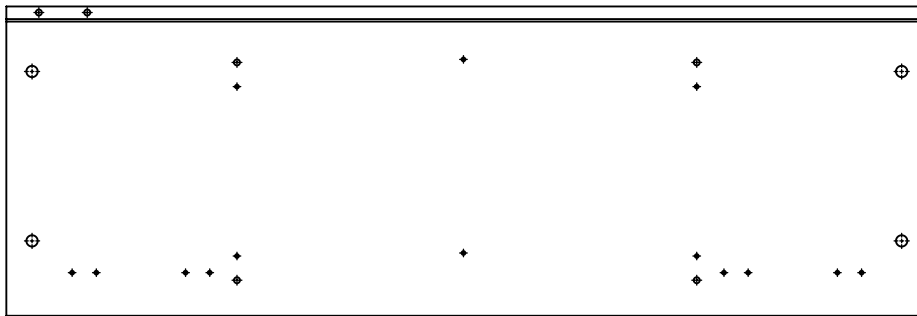

4. 1218x409x16 mm

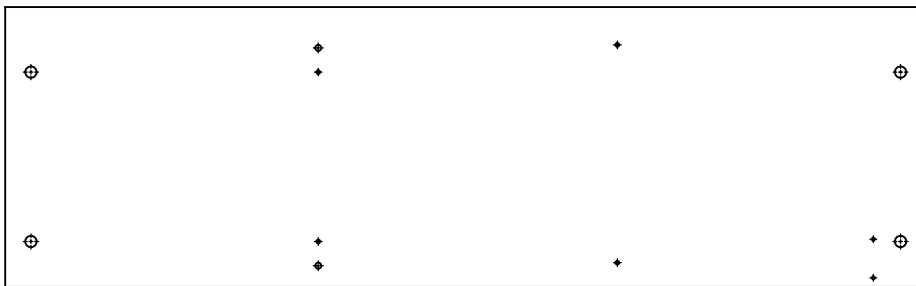

5. 1718x370x16 mm

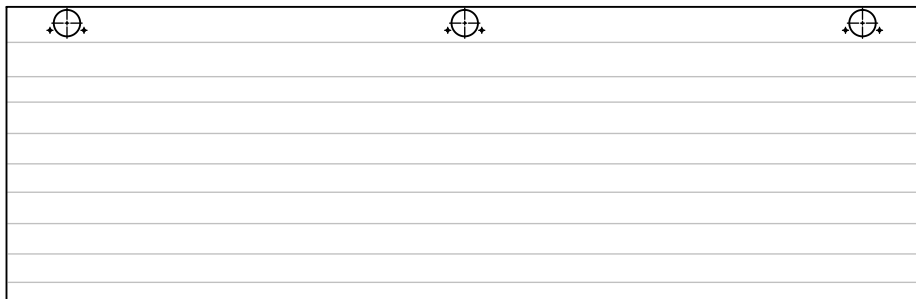

16. 1212x390x16 mm

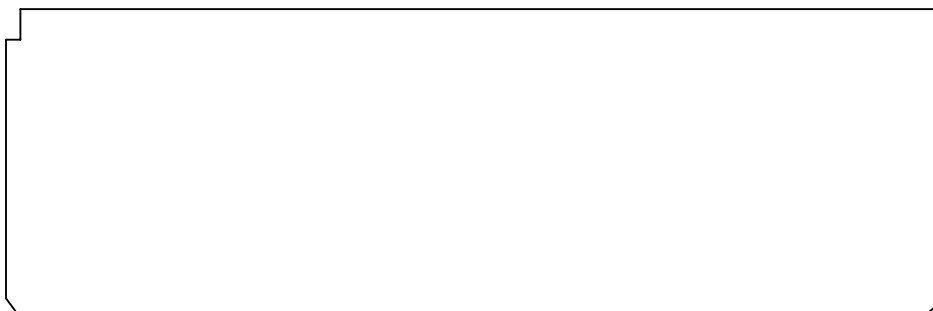

11. 1232x399x16 mm

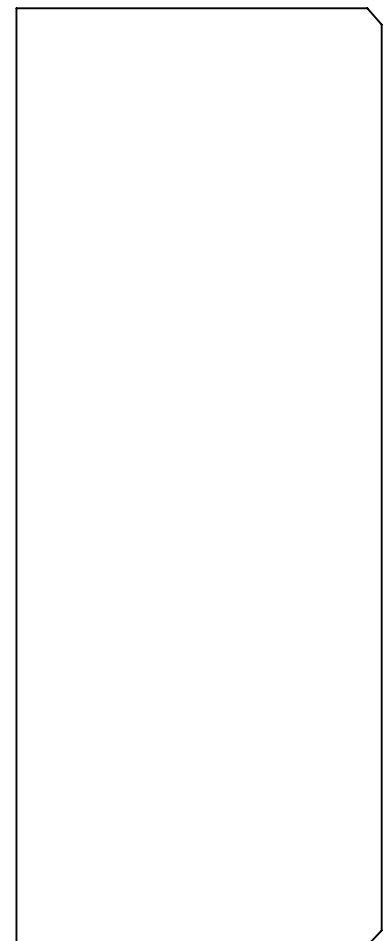

12. 1232x479x16 mm

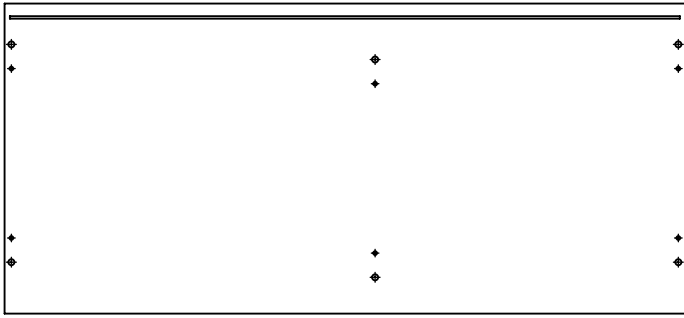

1. 900x410x16 mm

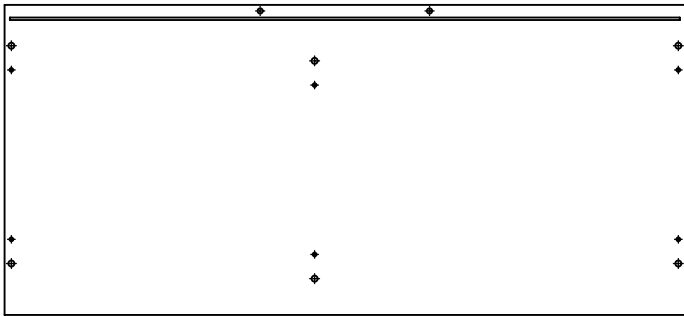

2. 900x410x16 mm



10. 866x150x16 mm

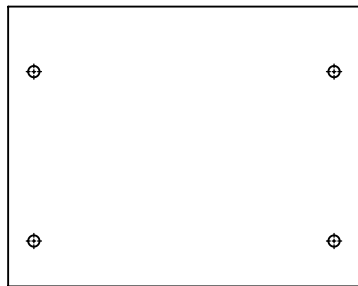

6. 465x370x16 mm x2

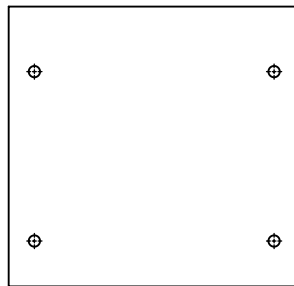

7. 485x370x16 mm

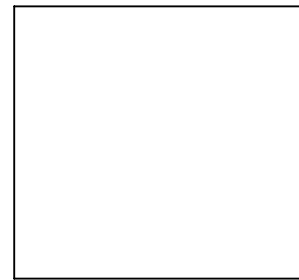

8. 485x360x16 mm

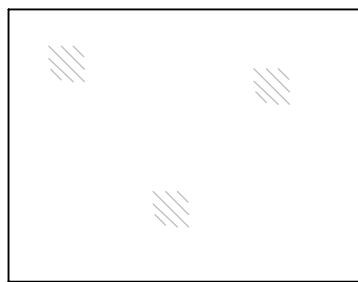

9. 464x350x4 mm

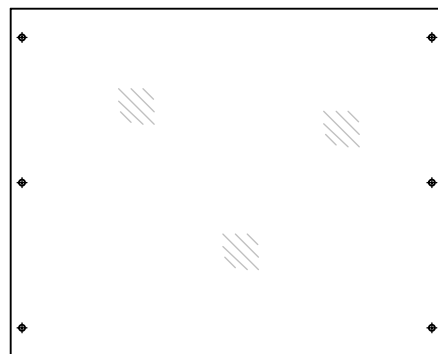

9. 572x460x4 mm

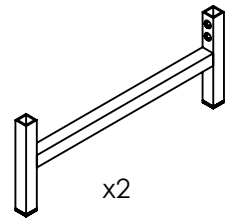

x2

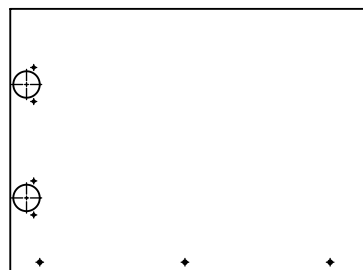

13. 470x350x16 mm

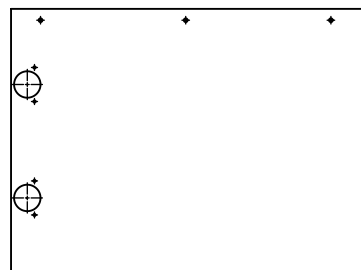

14. 470x350x16 mm

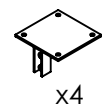

x4

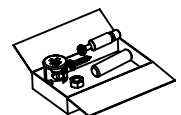

①

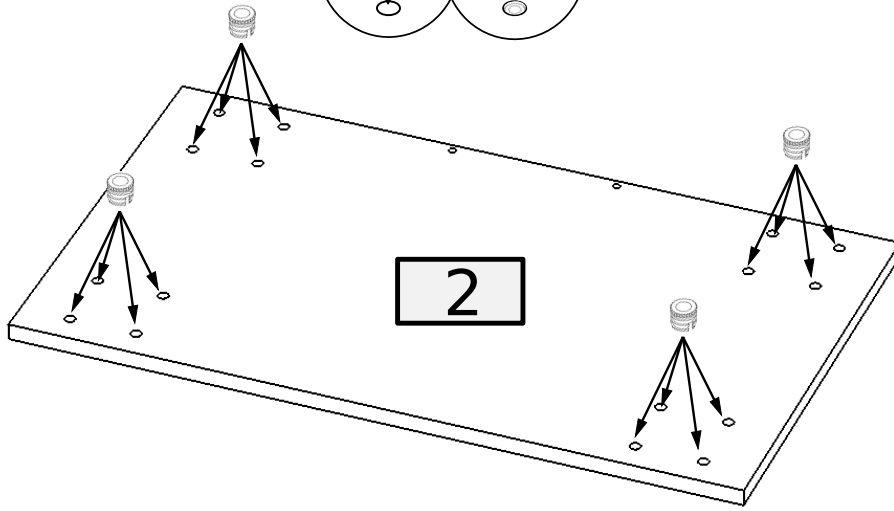
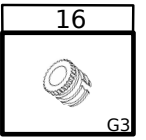
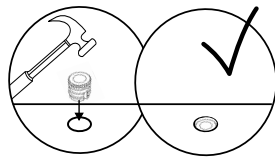

②

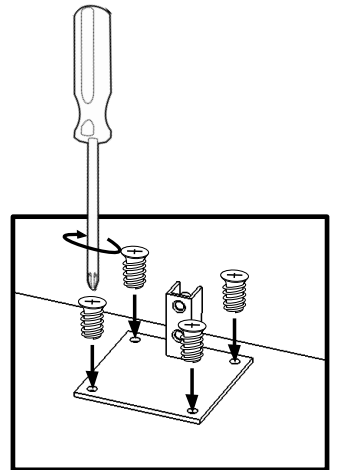
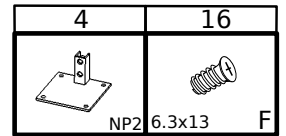
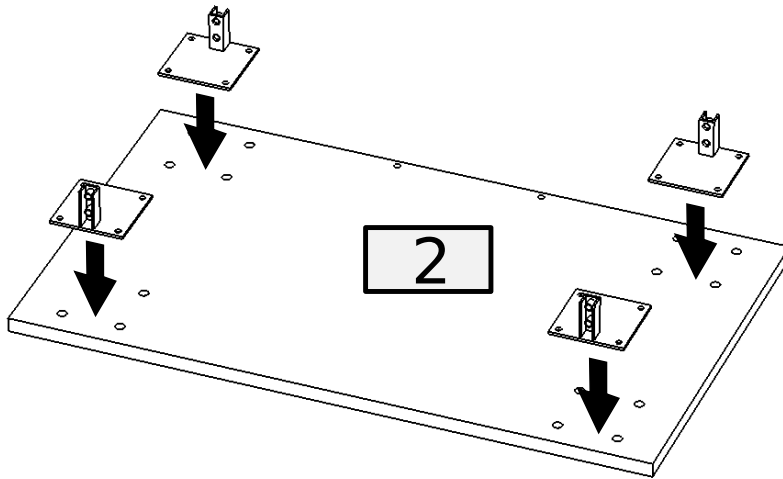

③

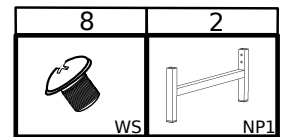
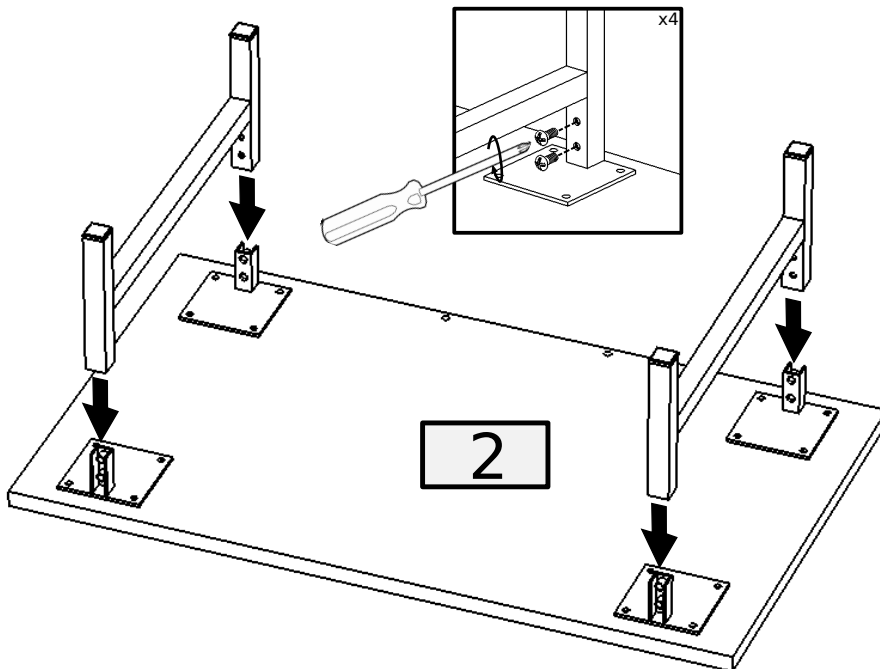

④

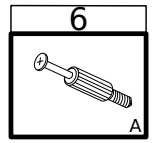
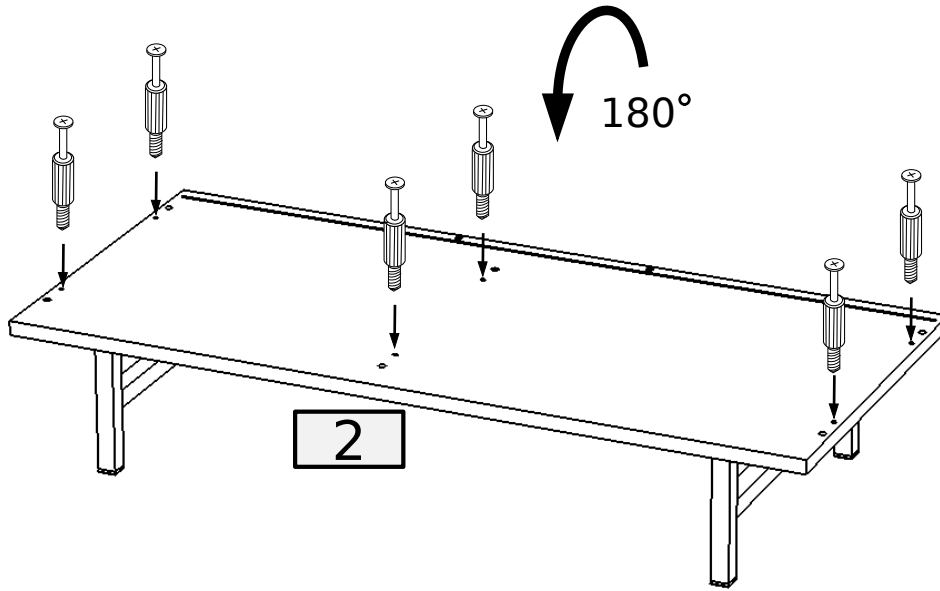

⑤

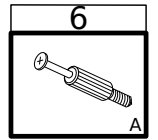
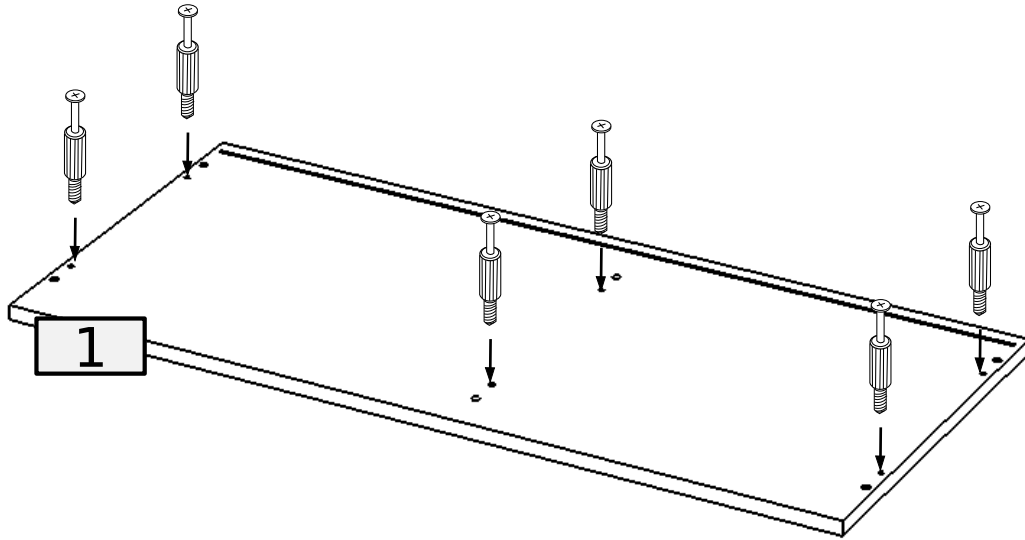

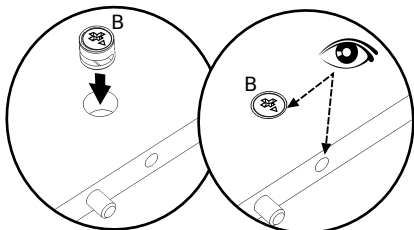
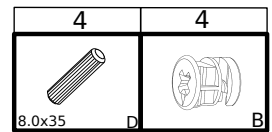
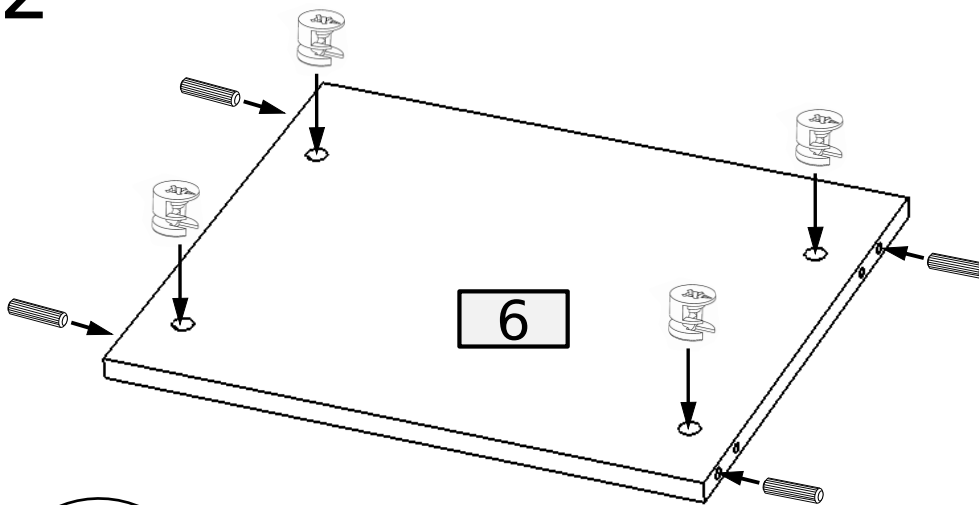

⑥x2

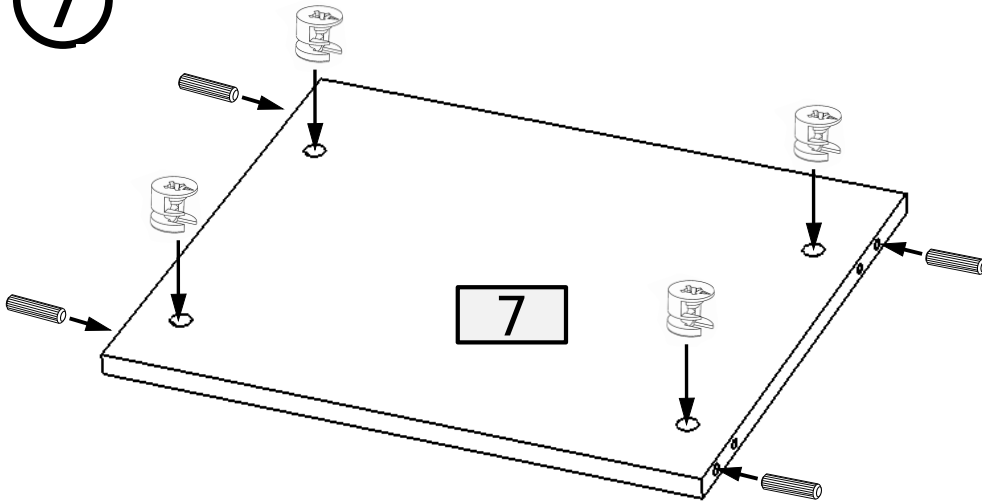

7



4	4
	
8.0x35	D B

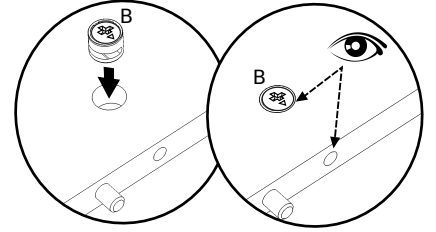

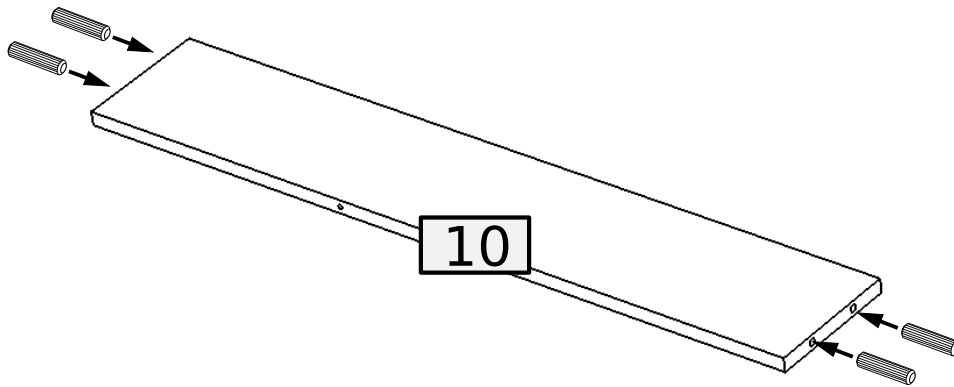

8

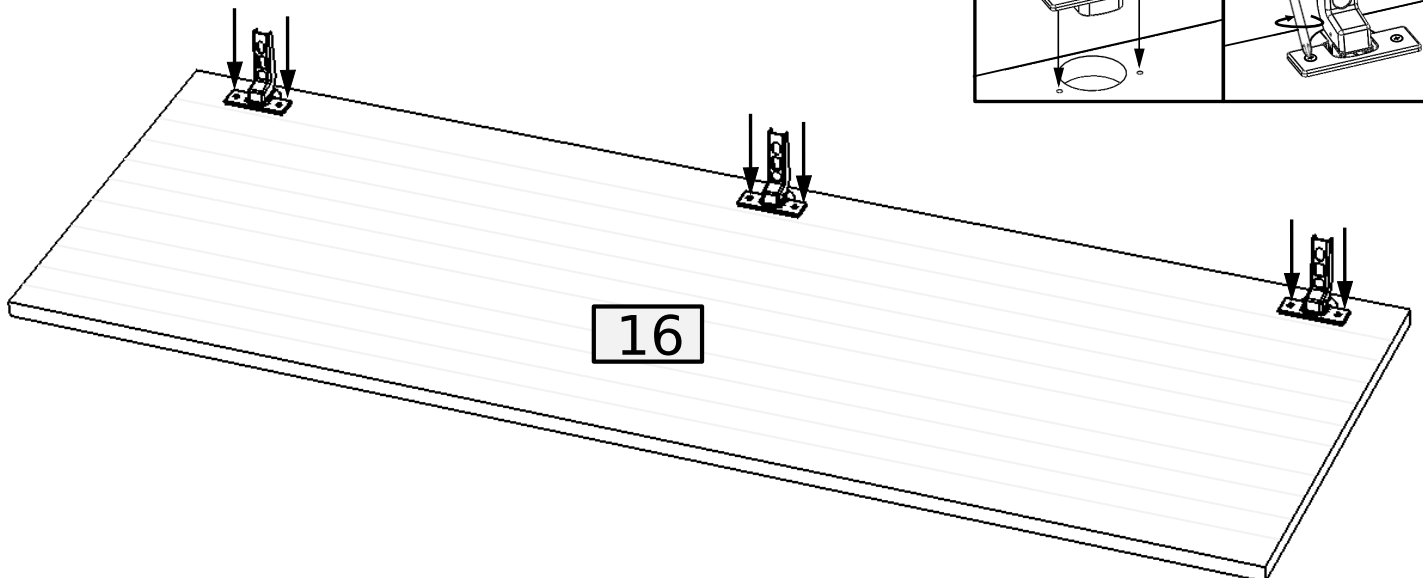

4

8.0x35

9



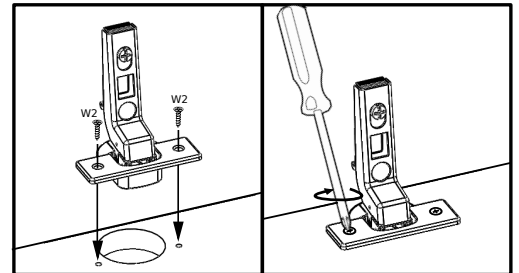

	
3.5x16 W2	Z
6	3



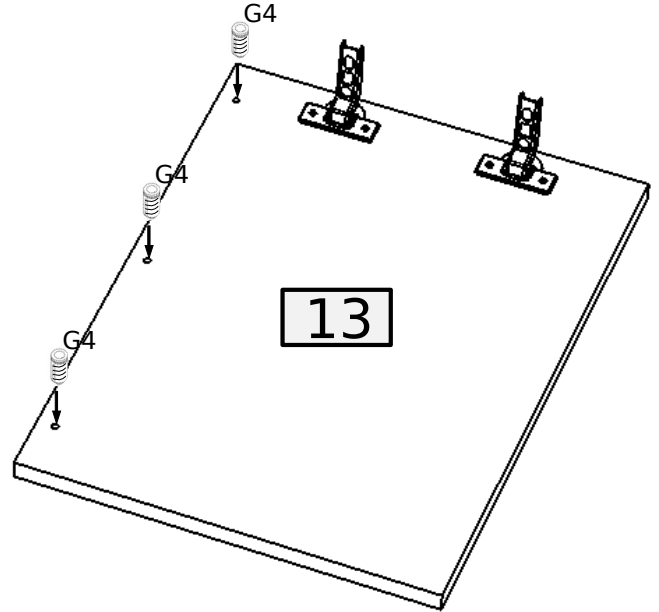
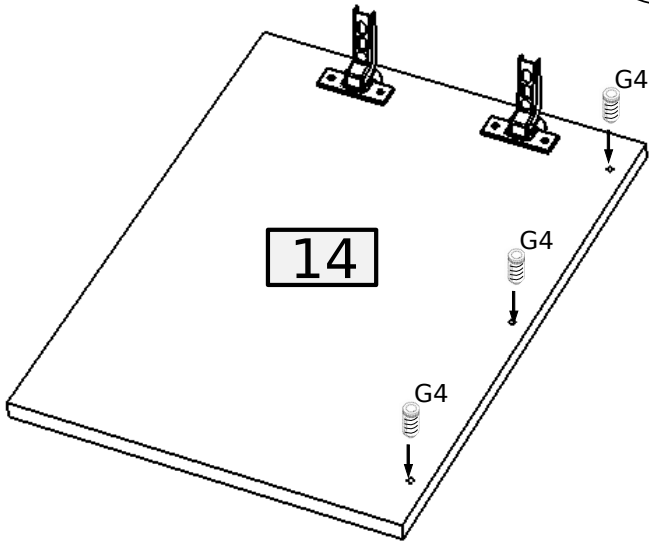
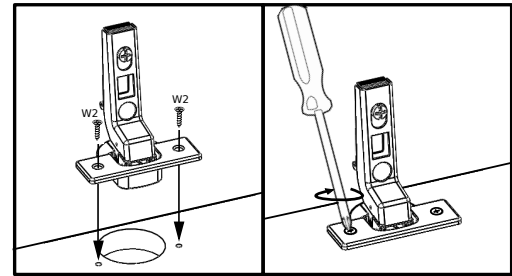
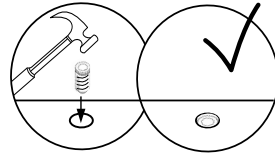

10



		
G4	3.5x16 W2	Z
6	8	4

11

	
3.5x16	W4T
6	6

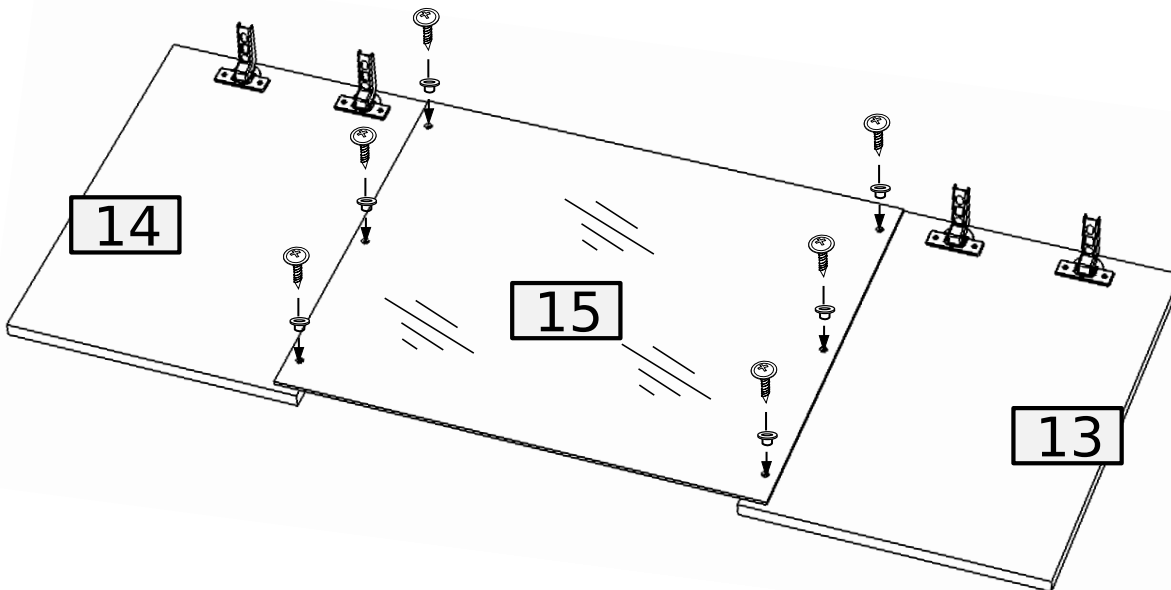

12

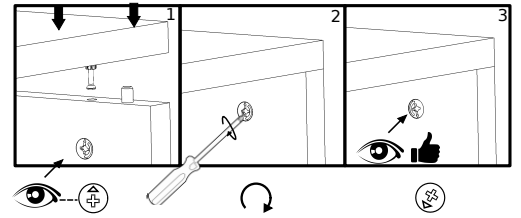
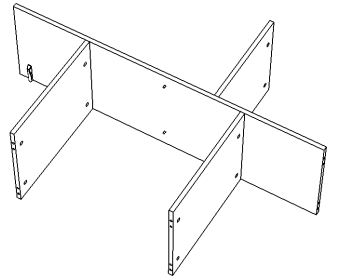
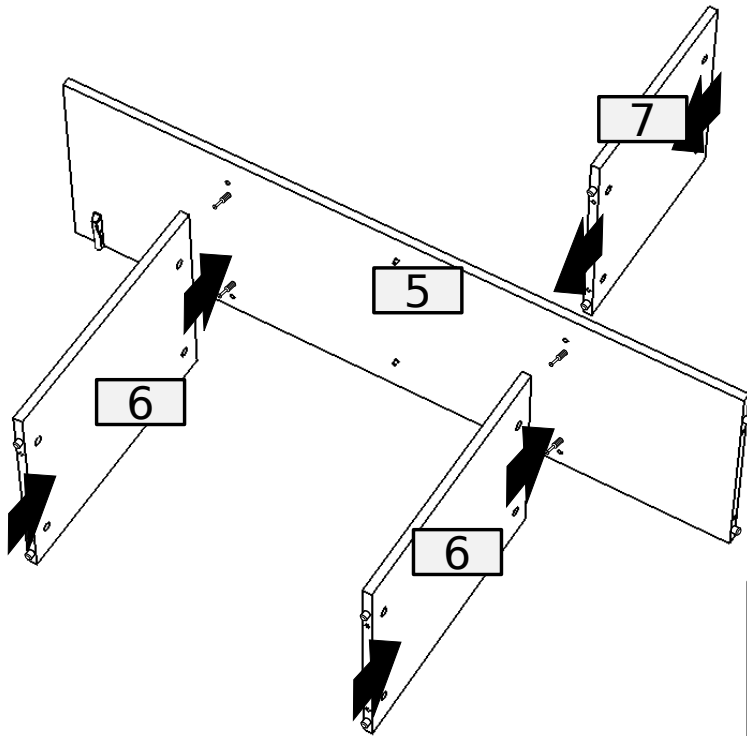

13

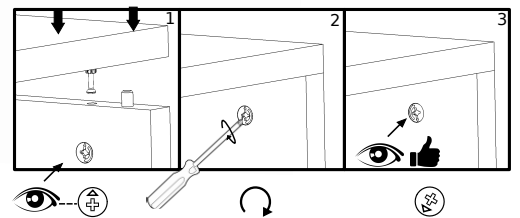
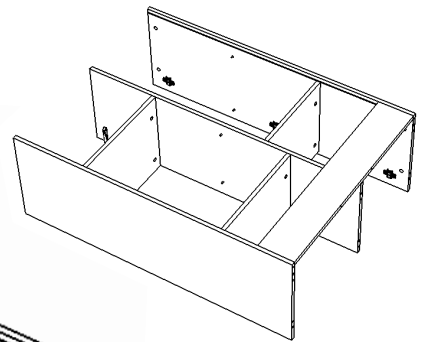
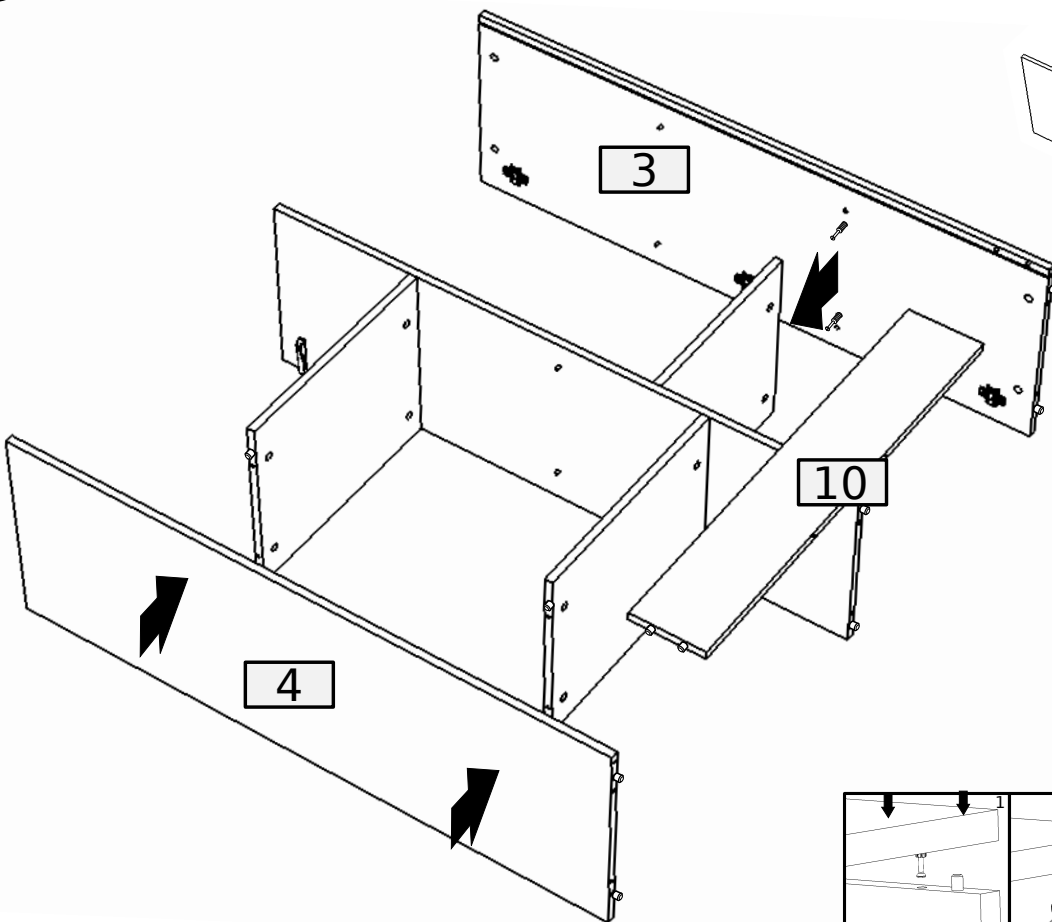

14

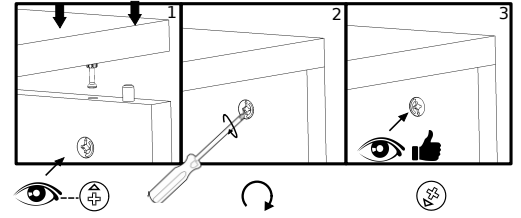
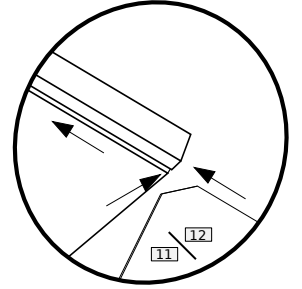
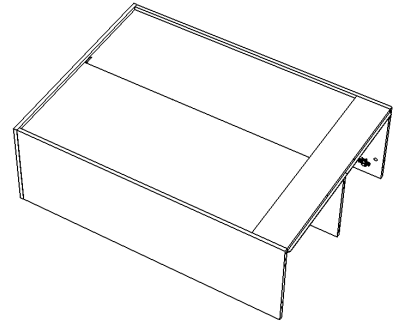
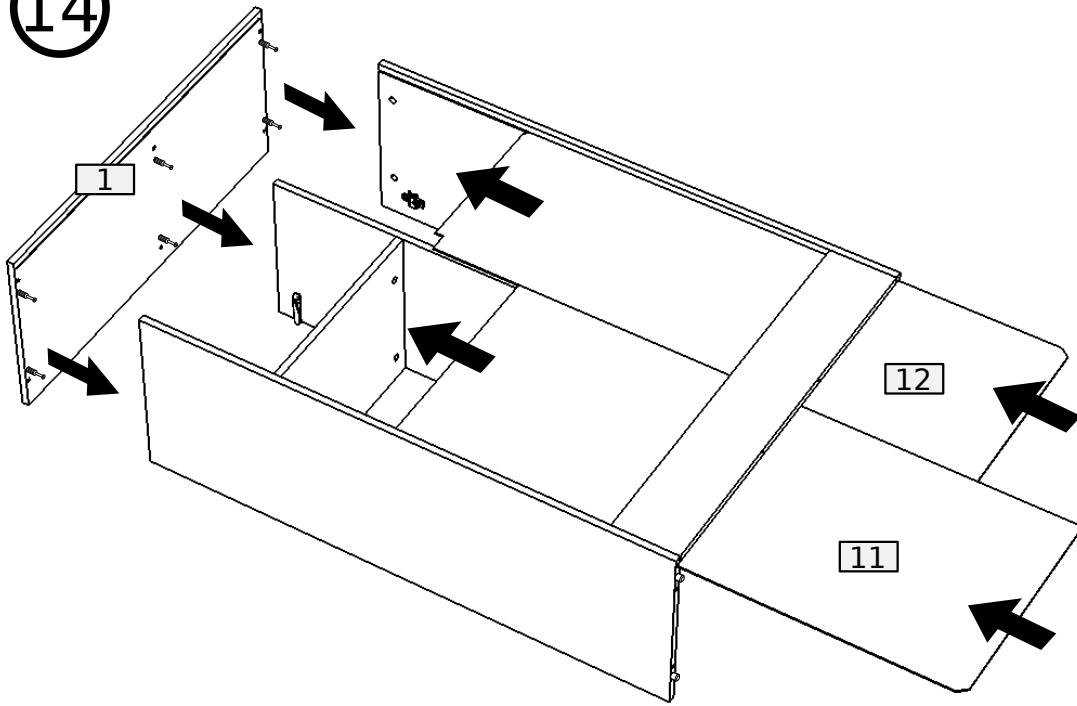

15

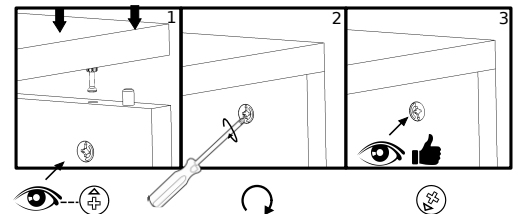
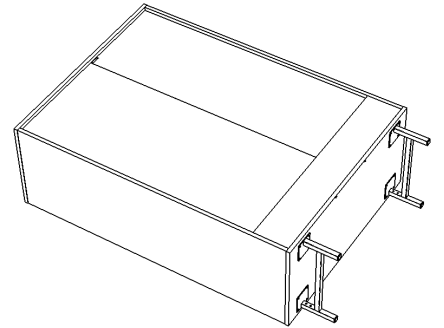
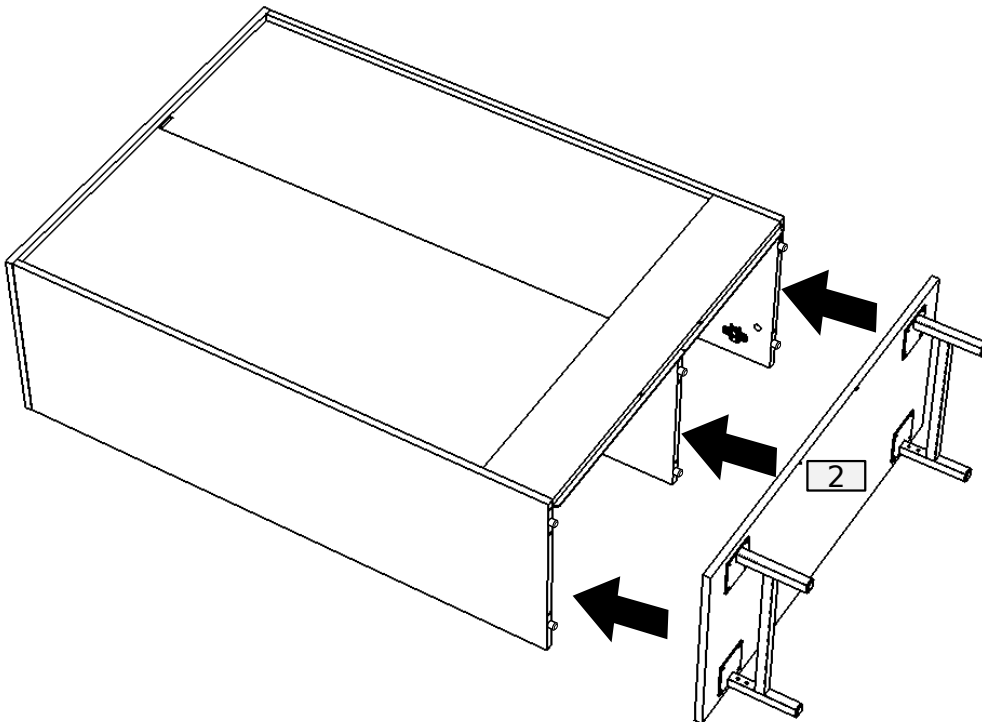

16

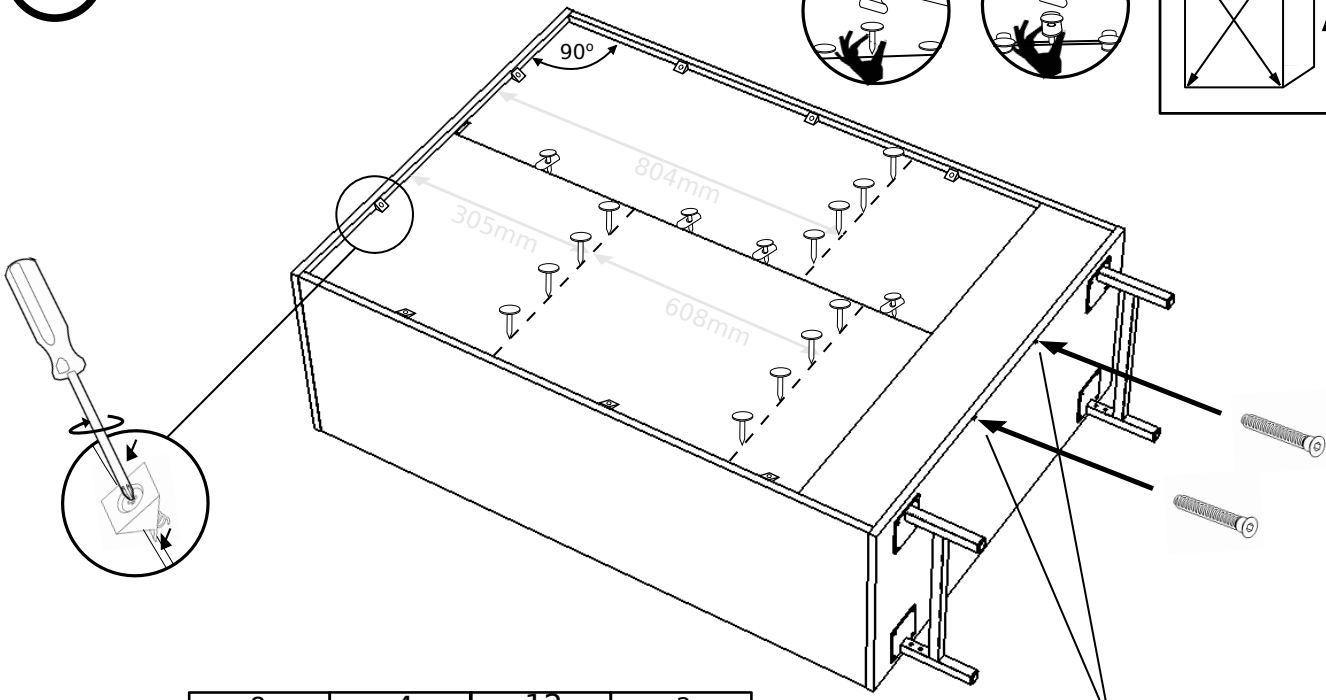
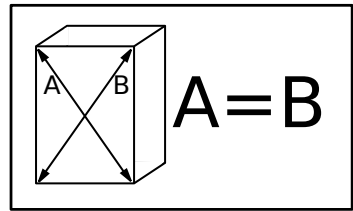
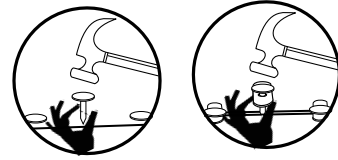

8	4	12	2
	G2	G	O

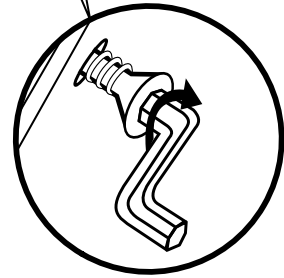

17

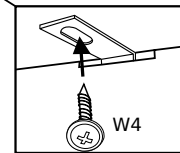
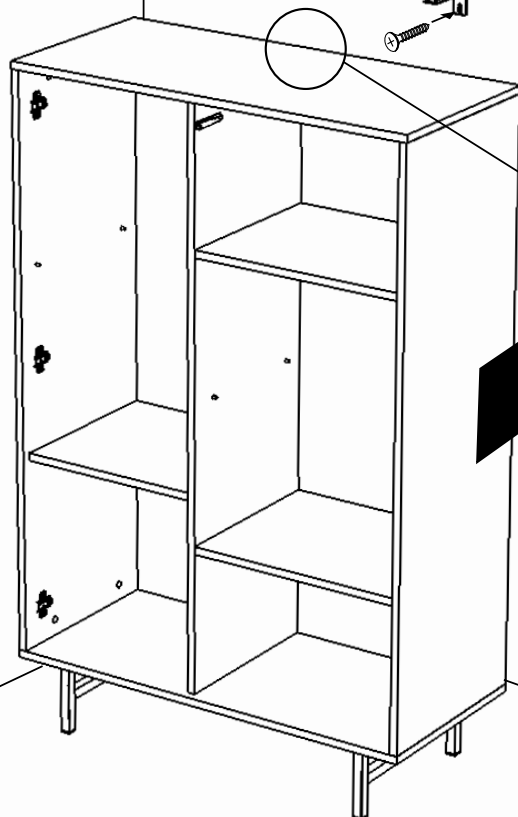
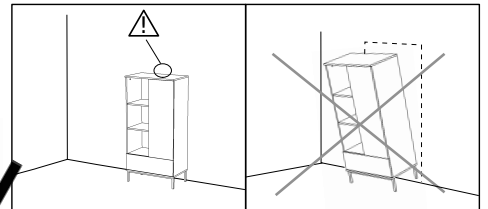
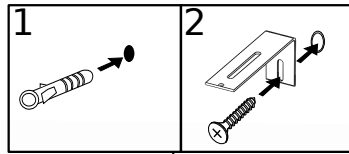

1	1
3.5x16	W4 KS

18

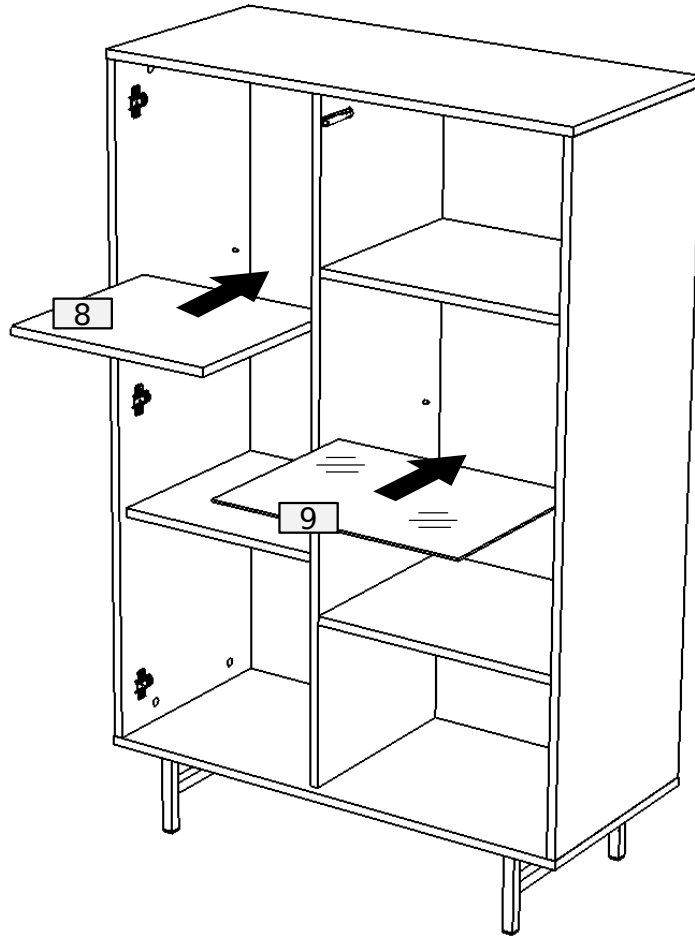

19

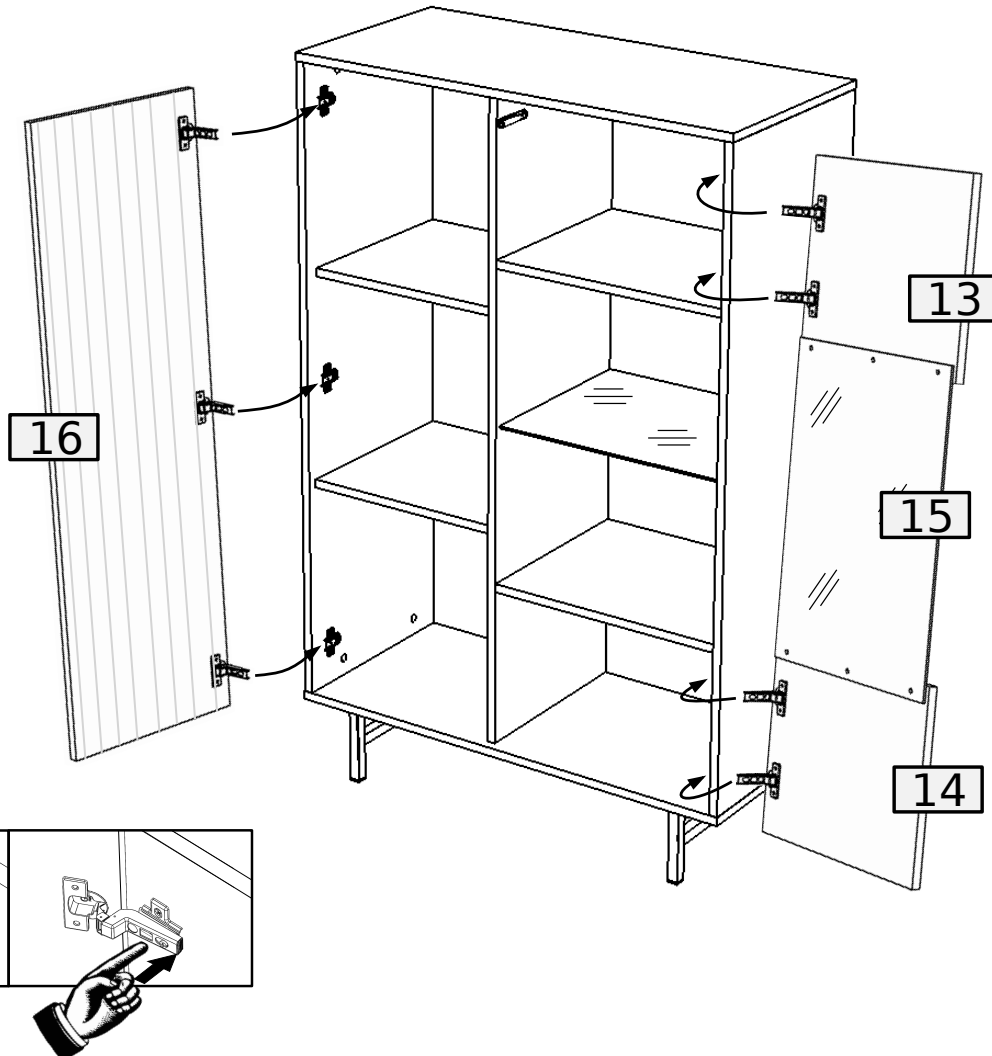

20

