





















 J	$\pm 5/16$ mm  K	 L	 M	 N	 O	$6,4 \times 50$ mm  P
	4	4	1	2	1	4	4
 A	$\pm 15/12$ mm  B	$\pm 8 \times 30$ mm  C	 D	 E	H-0  G	$\pm 35/0$ mm  H	$\pm 3.5 \times 13$ mm  I
12	12	18	10	12	6	6	18

							
A	B	C	M	I	J	P	N
12	12	18	2	2	4	4	1



3



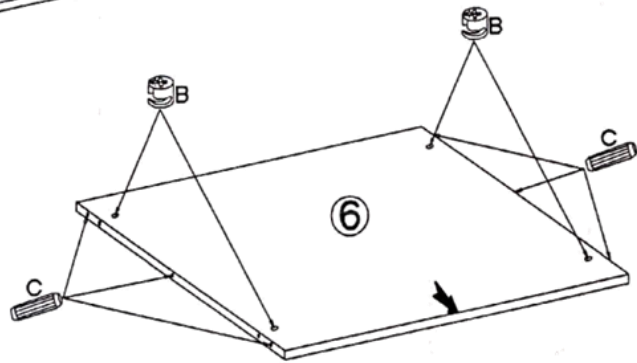
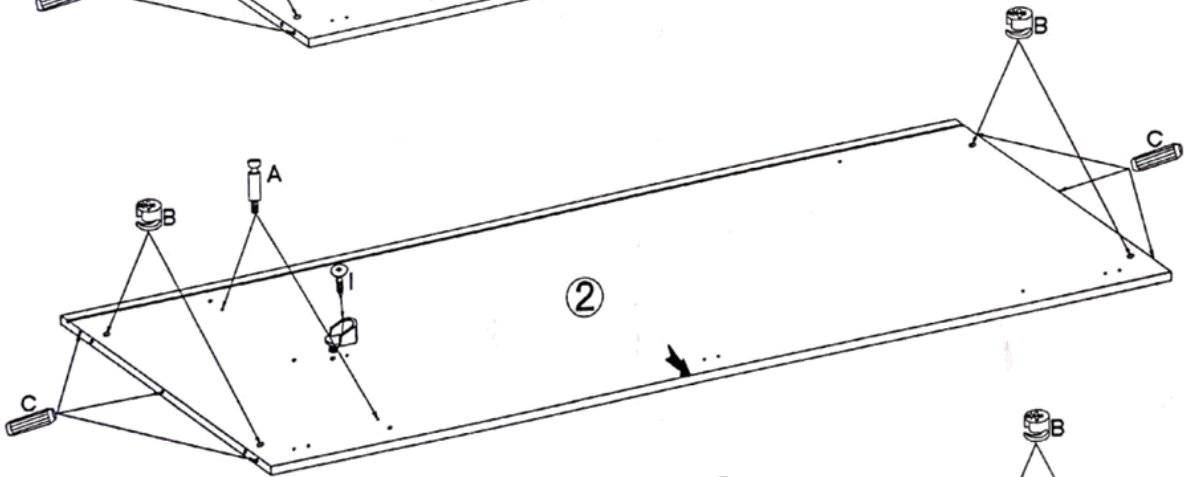
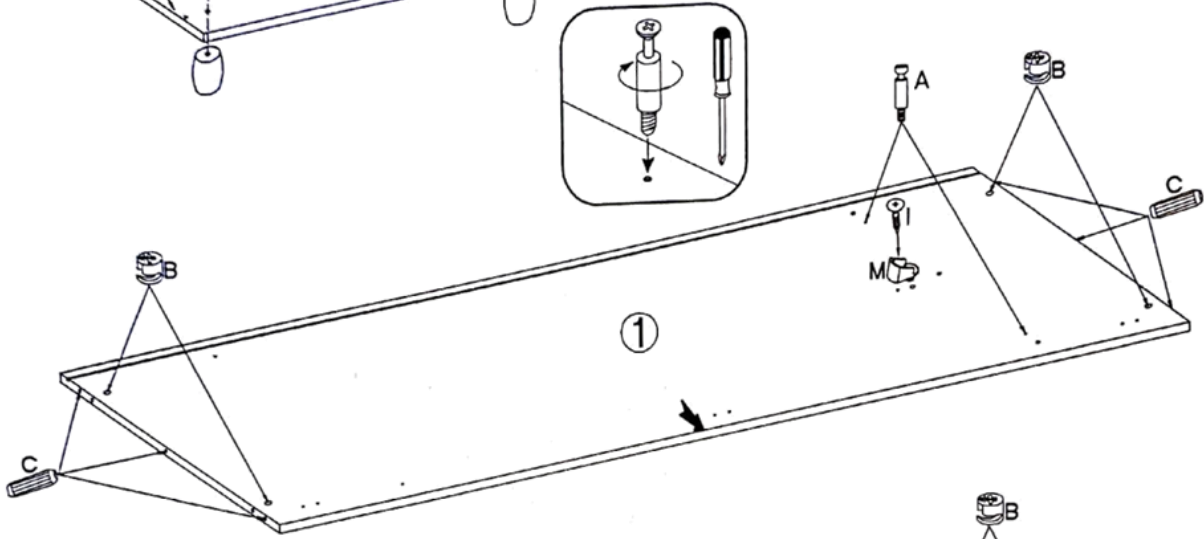
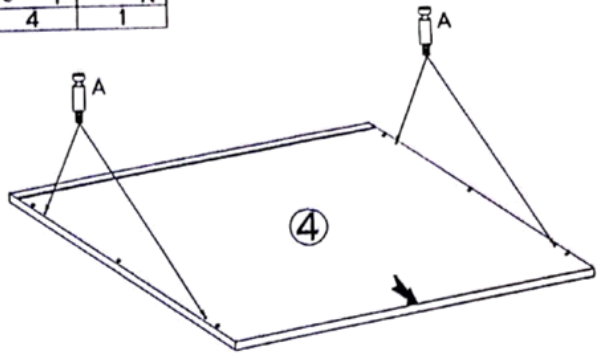
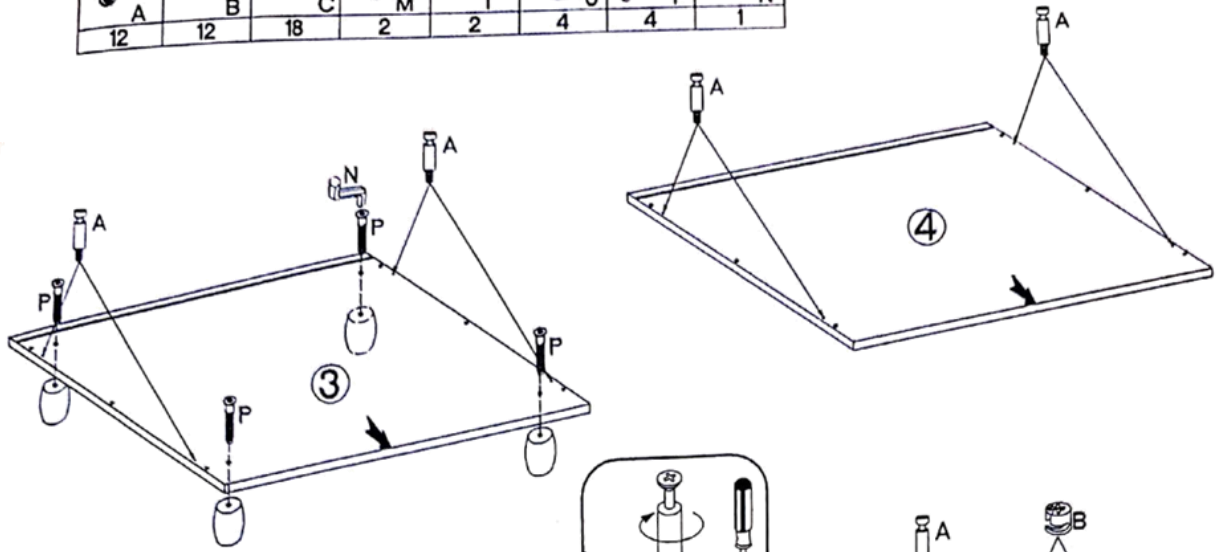
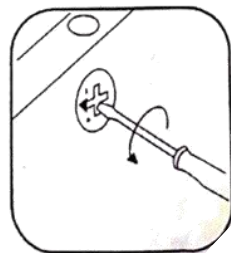
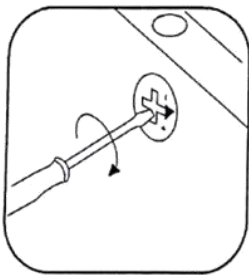
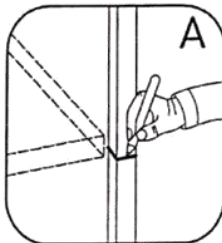
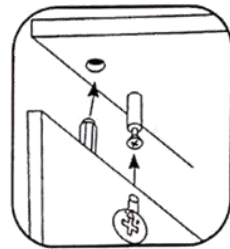
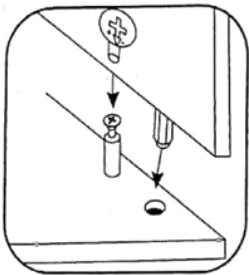
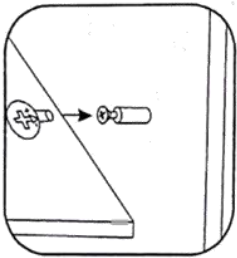
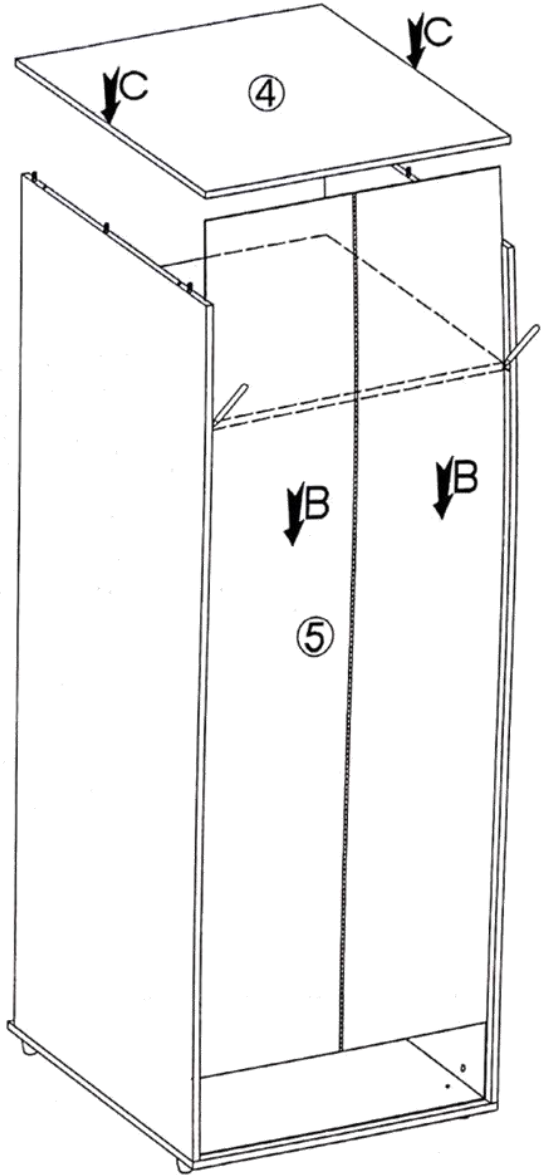
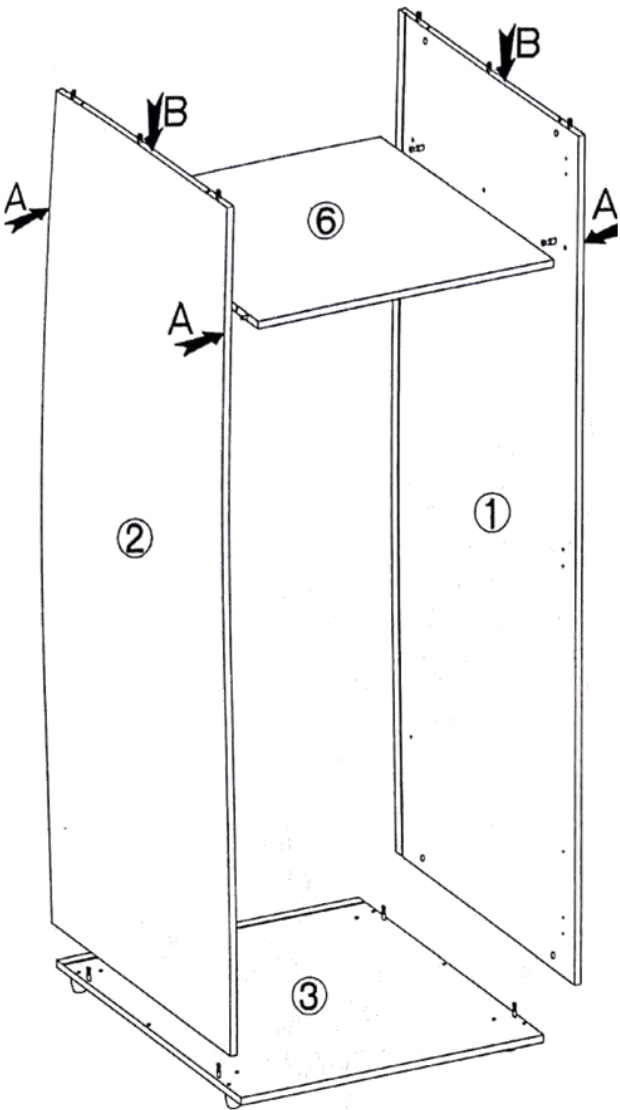
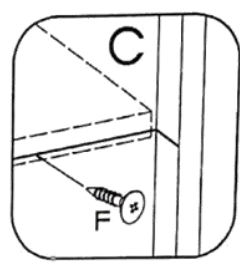
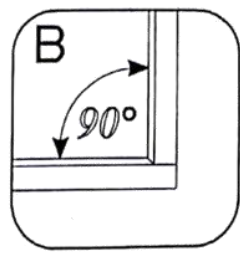
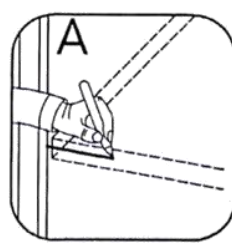
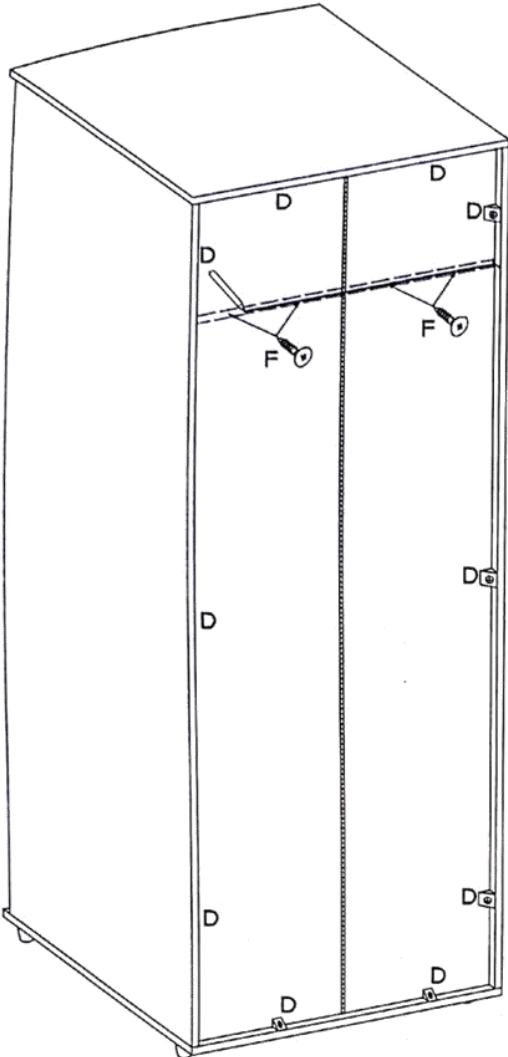

#3.0x20mm		
	F	D
	4	10

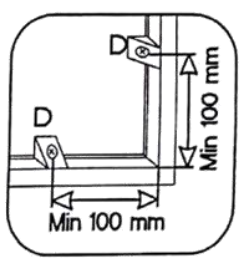
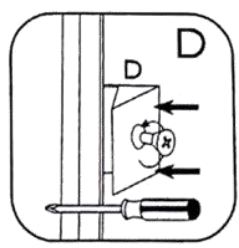

5

	#35/0mm	#3.5x13mm
G	H	I
6	6	12

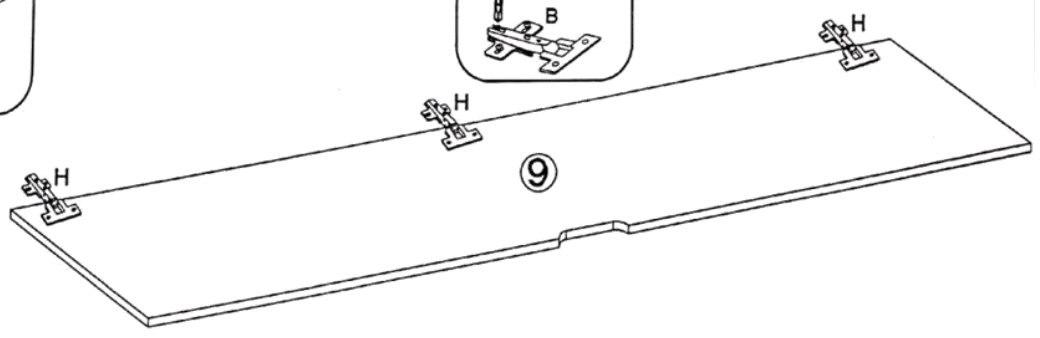
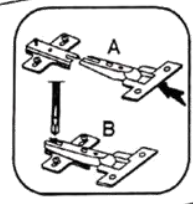
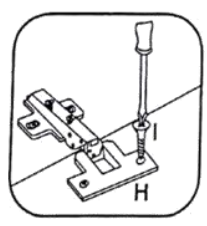
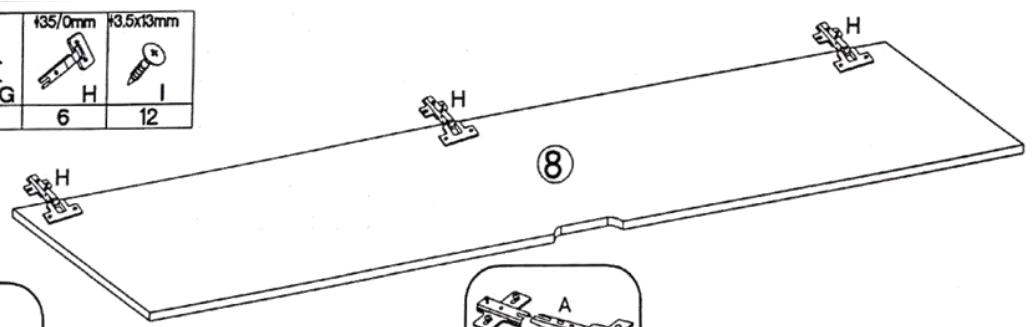

15/16mm K	L	E	O
4	1	12	4

