

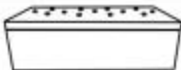
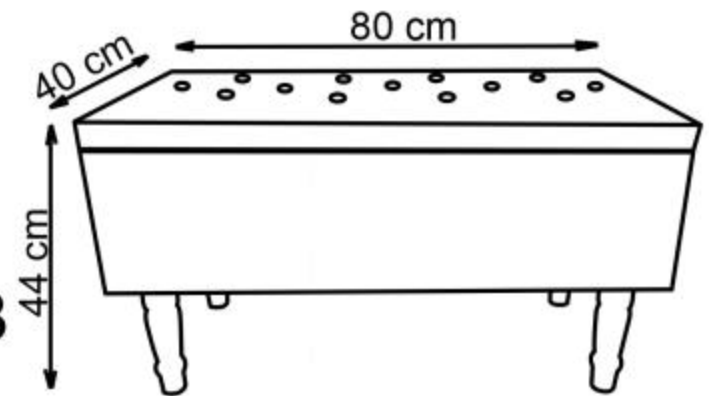

A		1
B		4

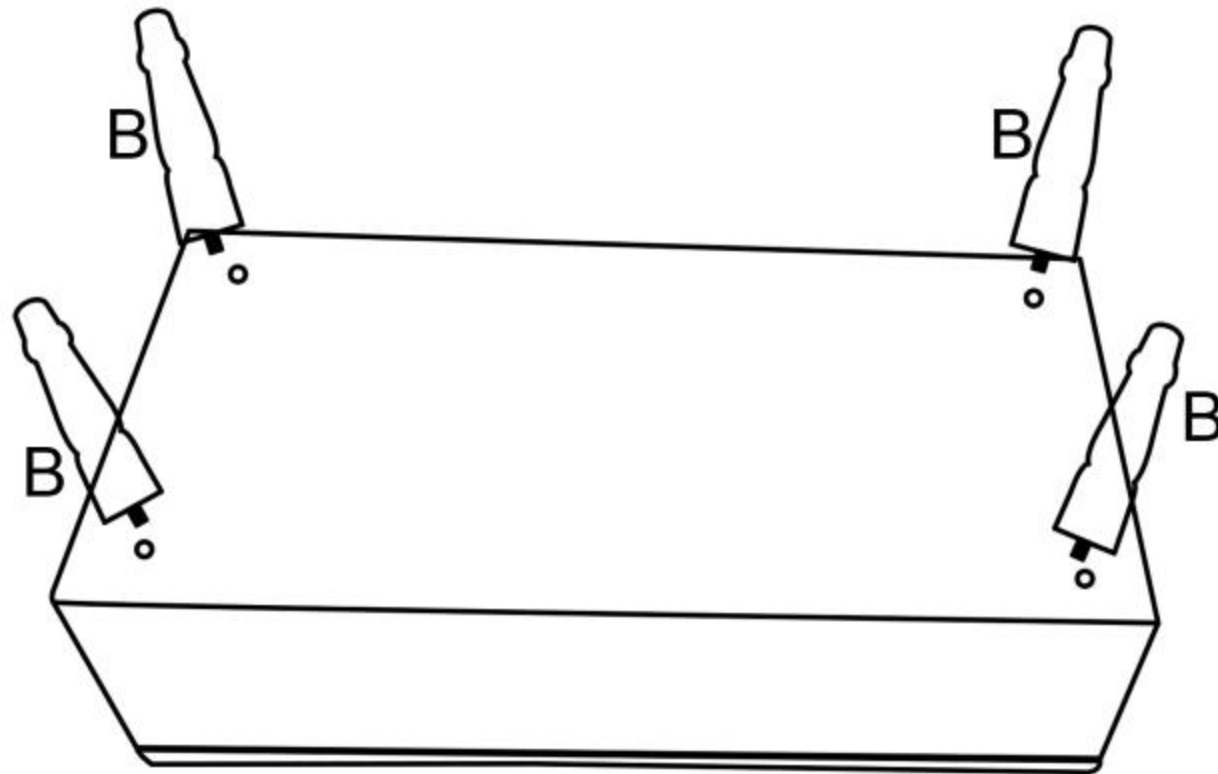

 max. 100kg