

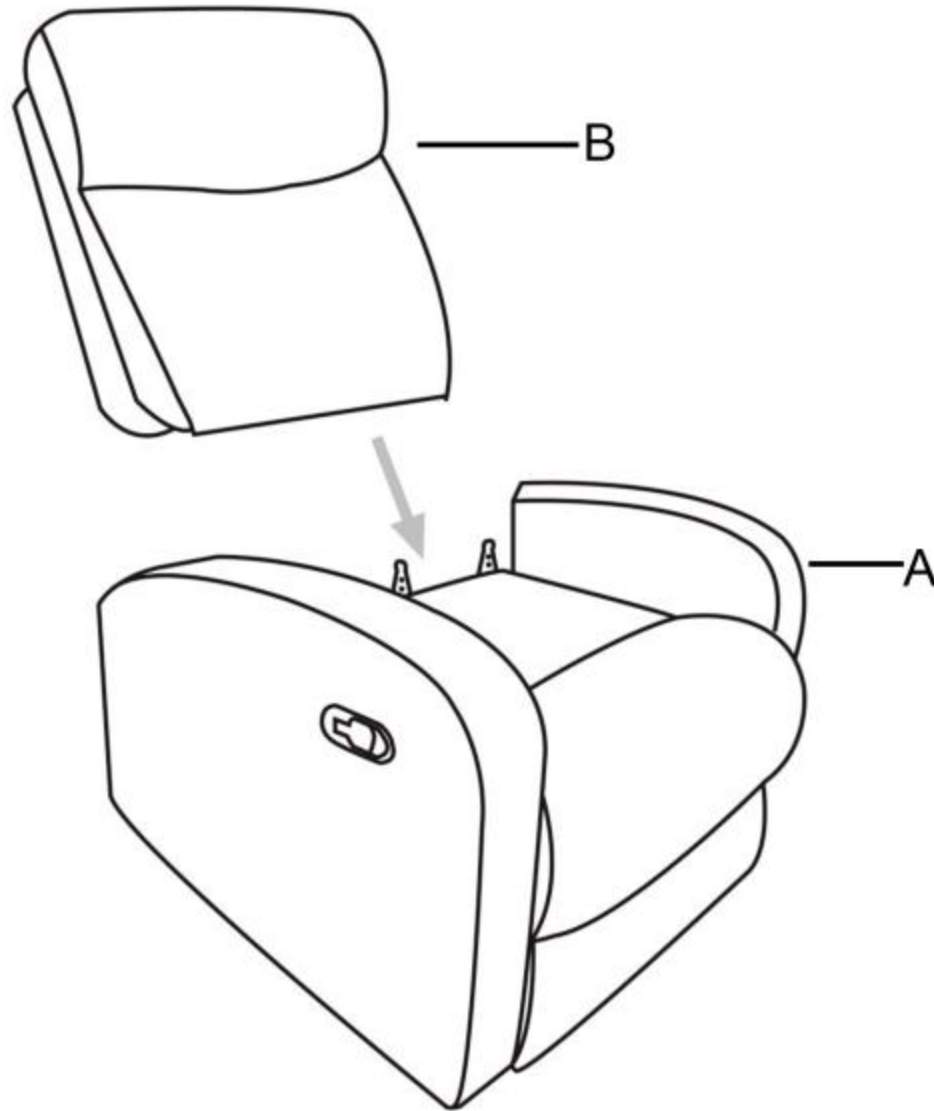

A		1
B		1



 max. 120 kg