













<p>8.0x30</p>  <p>D</p> <p>16</p>	<p>A</p>  <p>A</p> <p>16</p>	<p>Ø15x12</p>  <p>B</p> <p>16</p>	<p>X</p>  <p>X</p> <p>16</p>	<p>ZA</p>  <p>ZA</p> <p>2</p>	<p>4.0x30</p>  <p>G1</p> <p>4</p>	<p>3.0x16</p>  <p>H4</p> <p>2</p>	<p>I</p>  <p>I</p> <p>6</p>
<p>L</p>  <p>L</p> <p>4</p>	<p>"0"</p>  <p>Z</p> <p>4</p>	<p>KR</p>  <p>KR</p> <p>2</p>	<p>ODB</p>  <p>ODB</p> <p>1</p>				



3 / 4

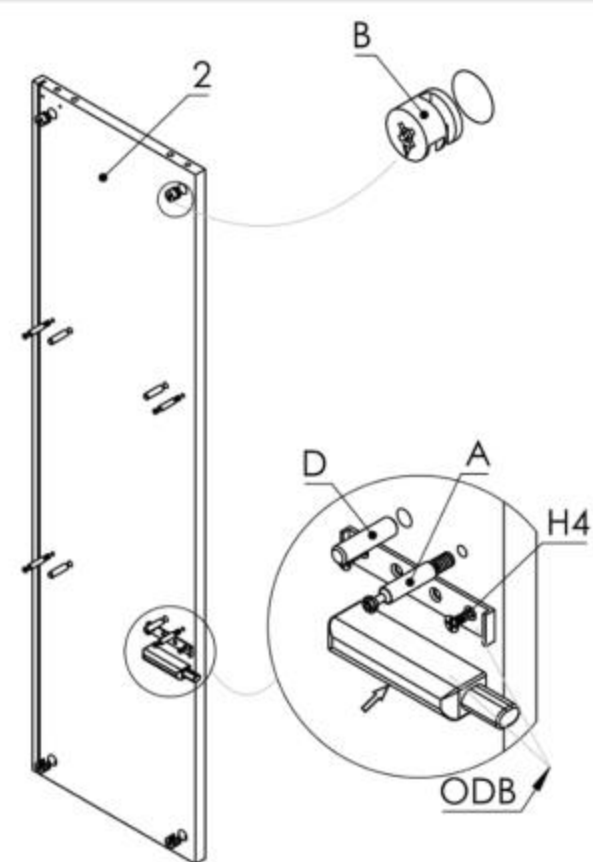
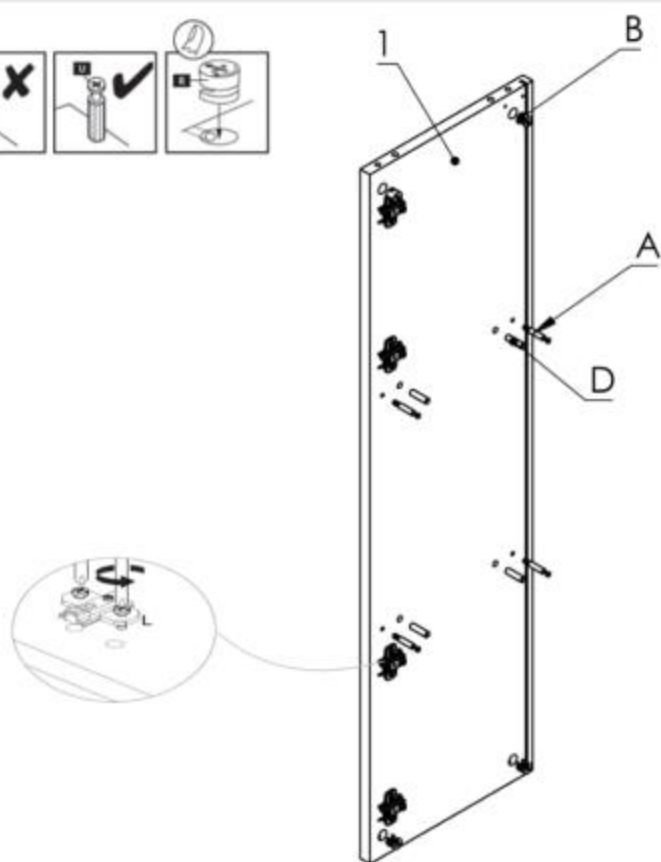
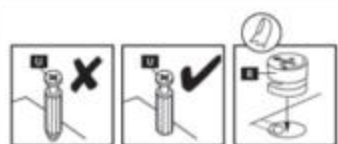
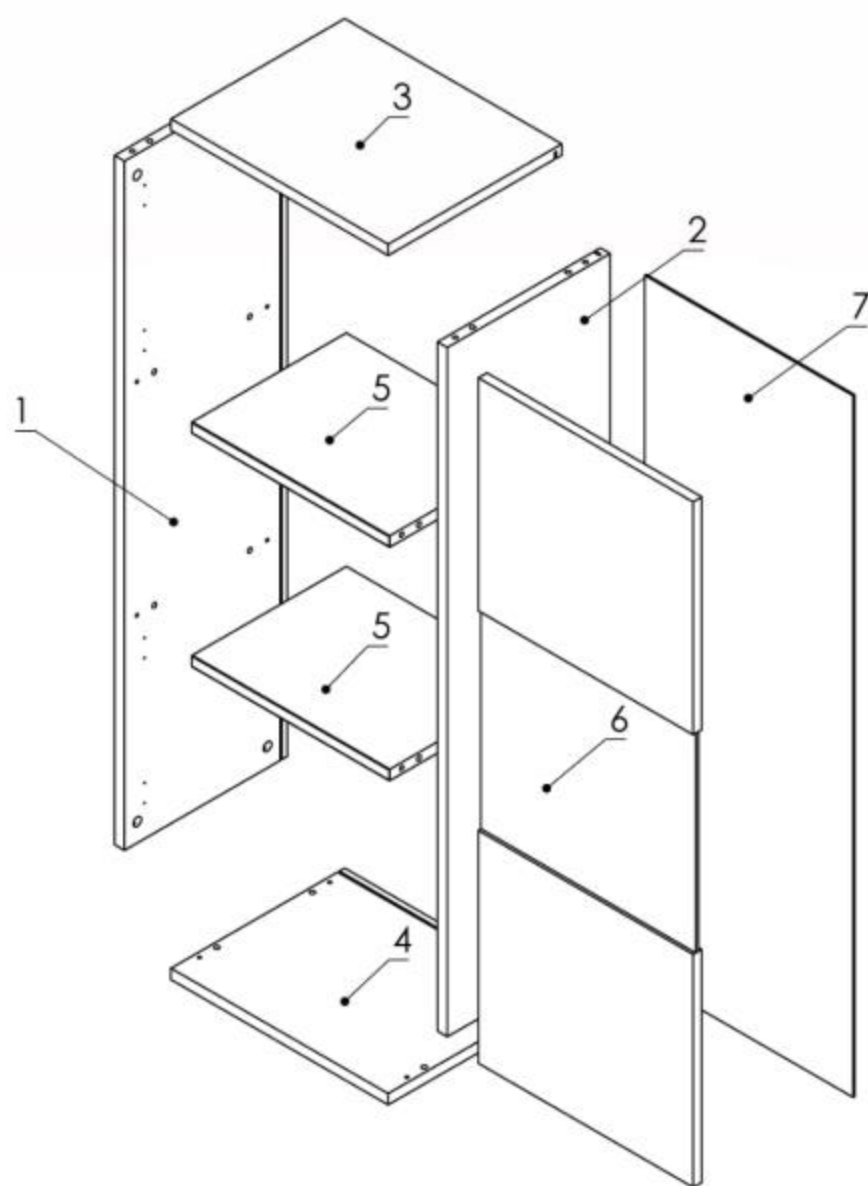