

1

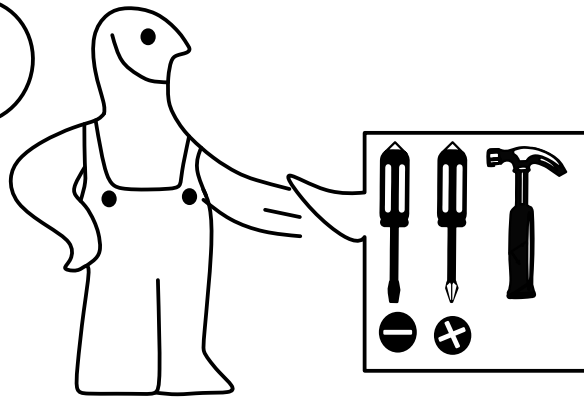

2

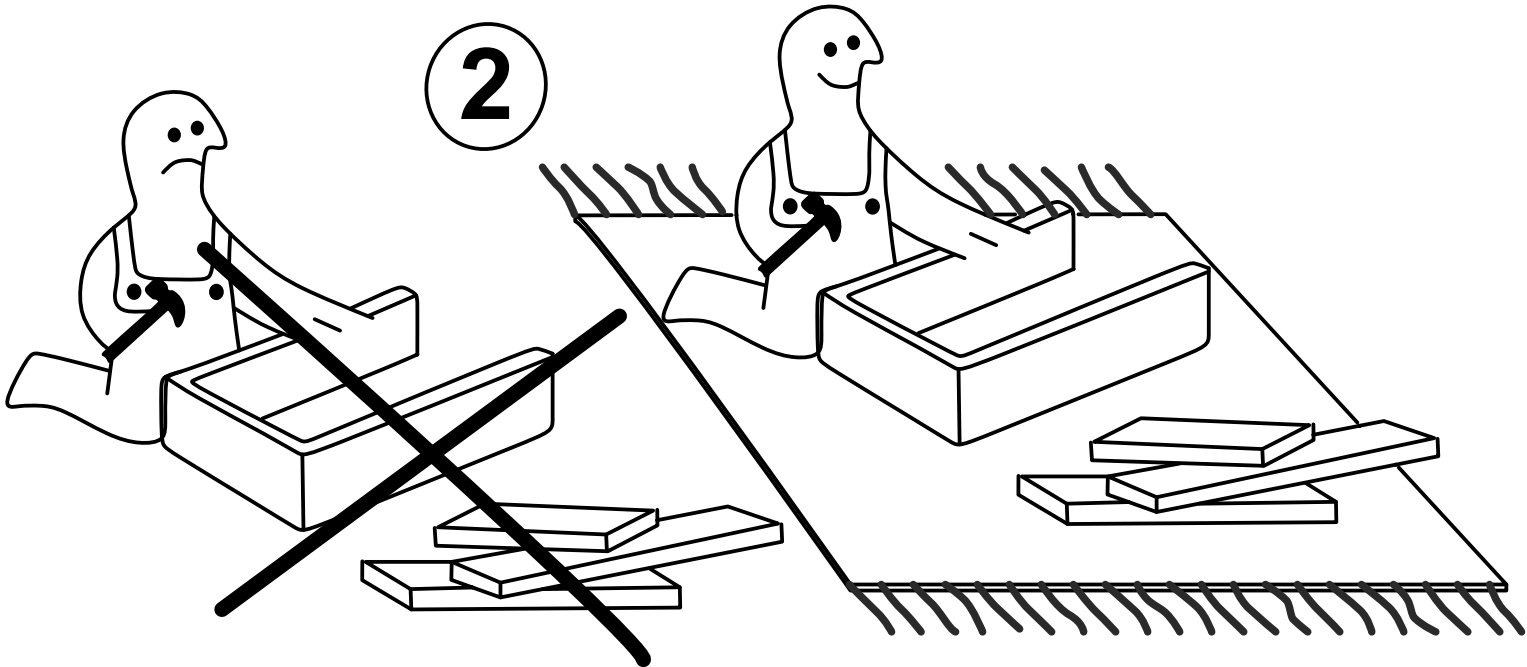

3

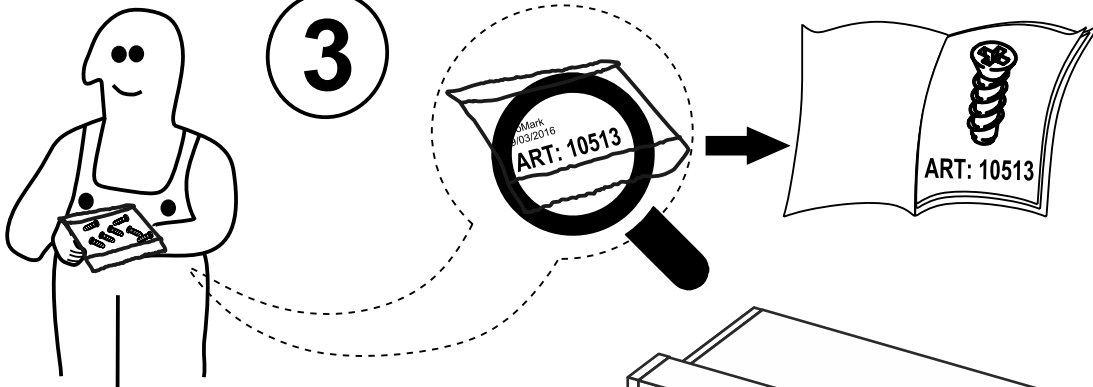

4

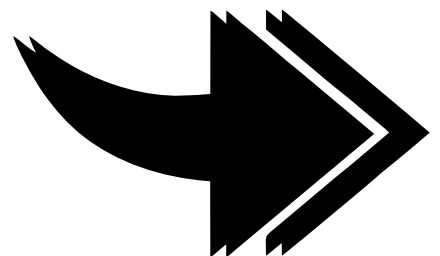
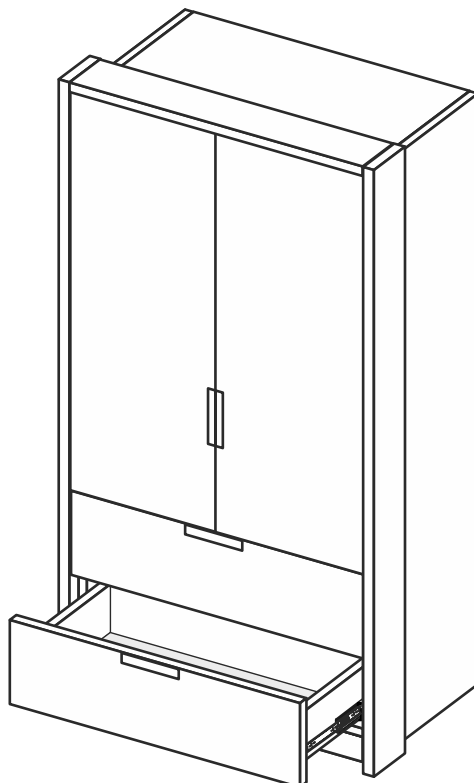
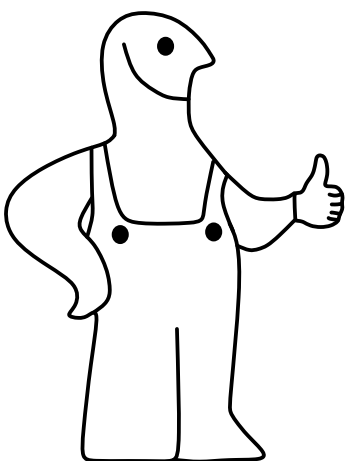

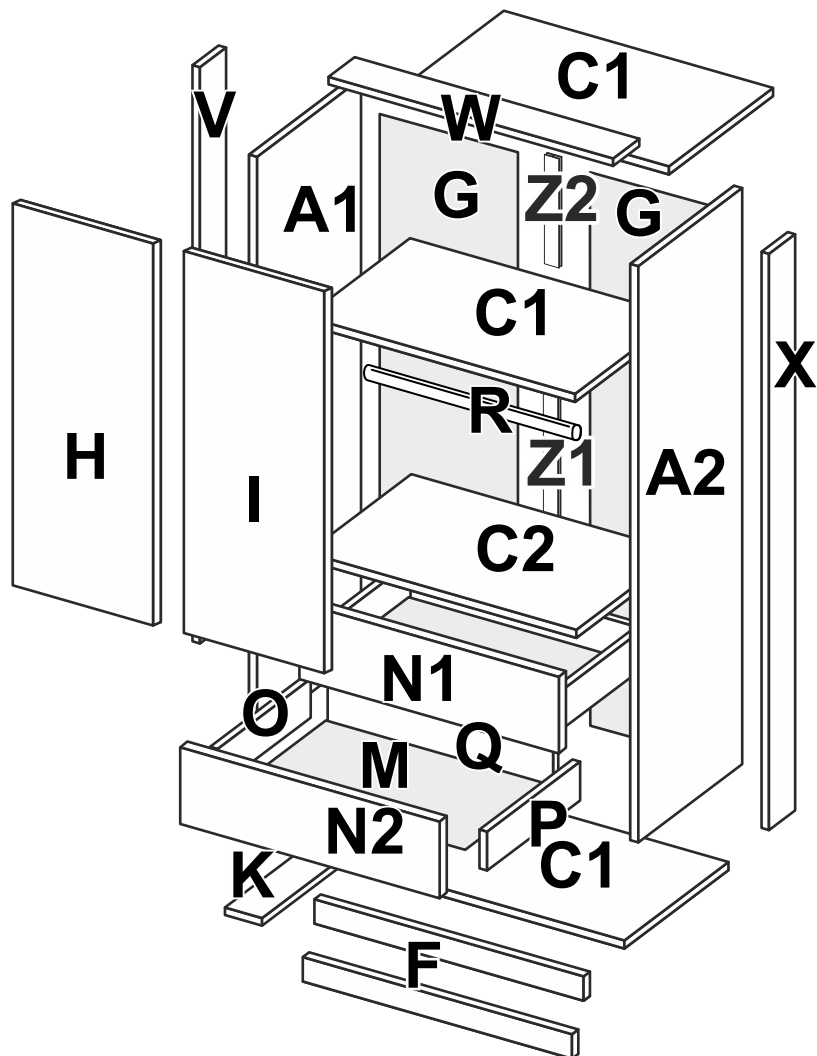

- A1-** 2104 x 530 x 16 - x 1
- A2-** 2104 x 530 x 16 - x 1
- C1-** 864 x 516 x 16 - x 3
- C2-** 864 x 514 x 16 - x 1
- F -** 864 x 50 x 16 - x 2
- G -** 2054 x 438 x 3 - x 2
- H -** 1550 x 444 x 16 - x 1
- I -** 1550 x 444 x 16 - x 1
- K -** 434 x 80 x 16 - x 2
- M -** 818 x 446 x 3 - x 2
- N1-** 892 x 246 x 16 - x 1
- N2-** 892 x 246 x 16 - x 1
- O -** 450 x 136 x 16 - x 2
- P -** 450 x 136 x 16 - x 2
- Q -** 806 x 136 x 16 - x 2
- R -** 857 - x 1
- Z1-** 1606MM - x 1
- Z2-** 394MM - x 1
- V -** 2132x110x 28 - x 1
- W-** 897x110 x 28 - x 1
- X -** 2132x110x 28 - x 1

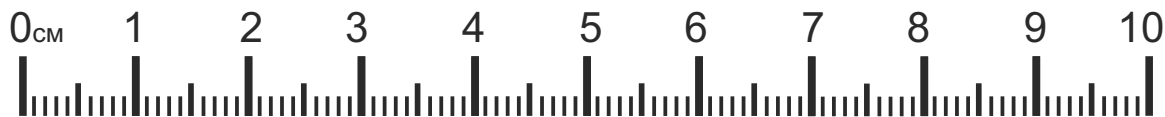
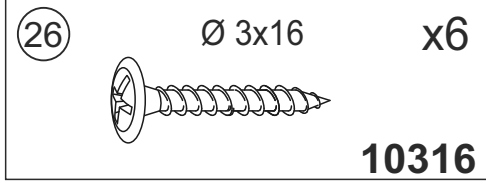
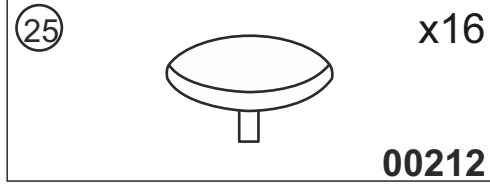
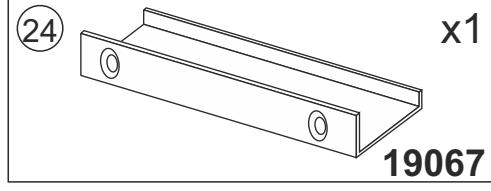
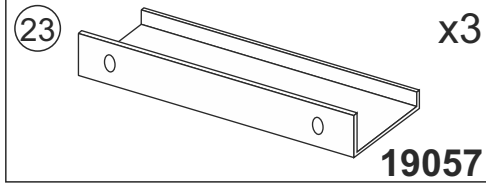
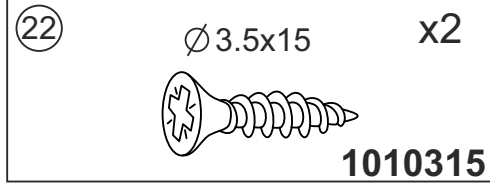
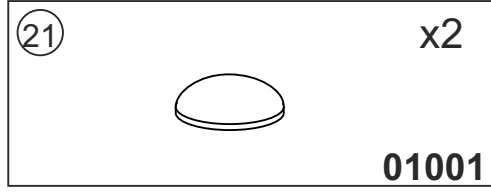
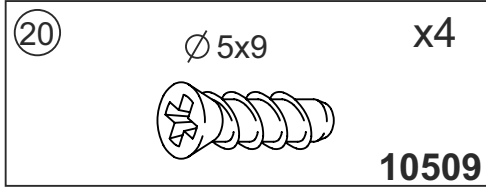
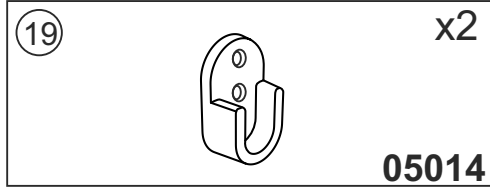
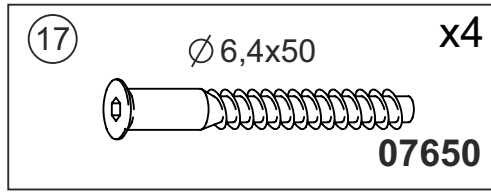
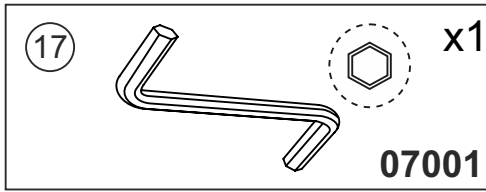
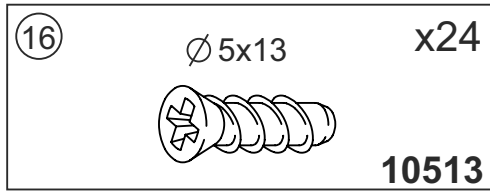
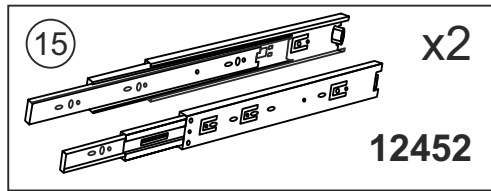
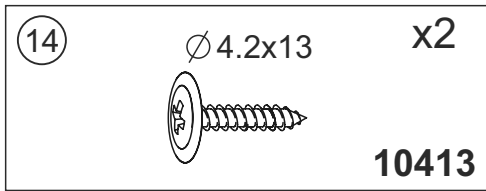
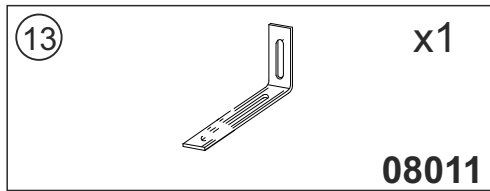
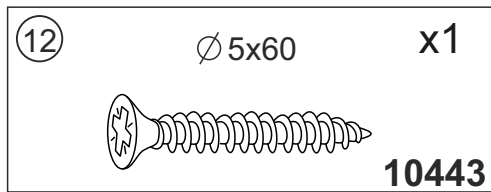
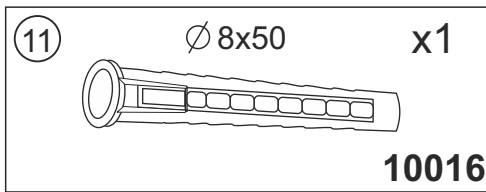
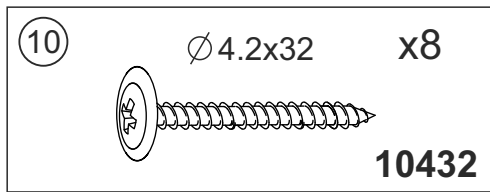
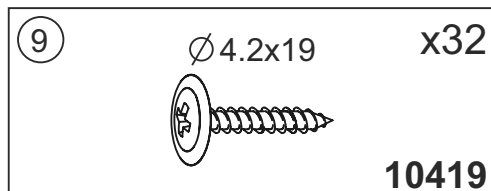
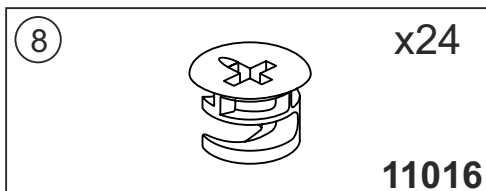
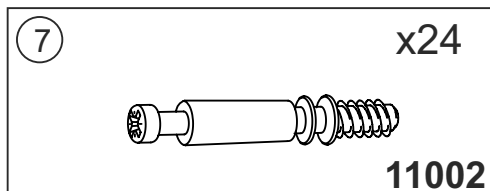
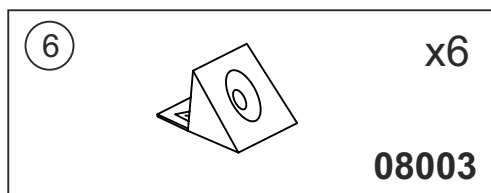
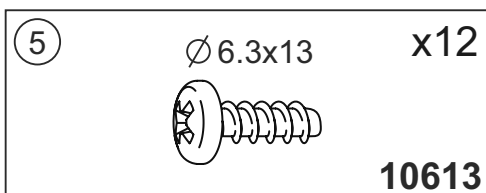
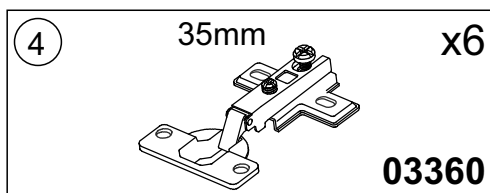
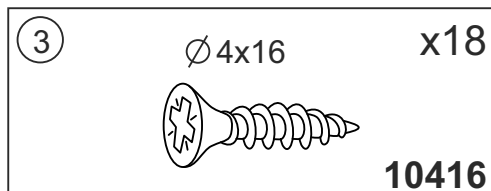
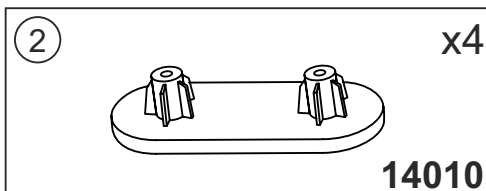
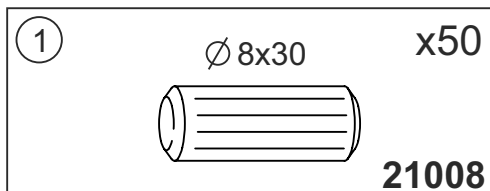

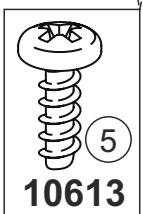
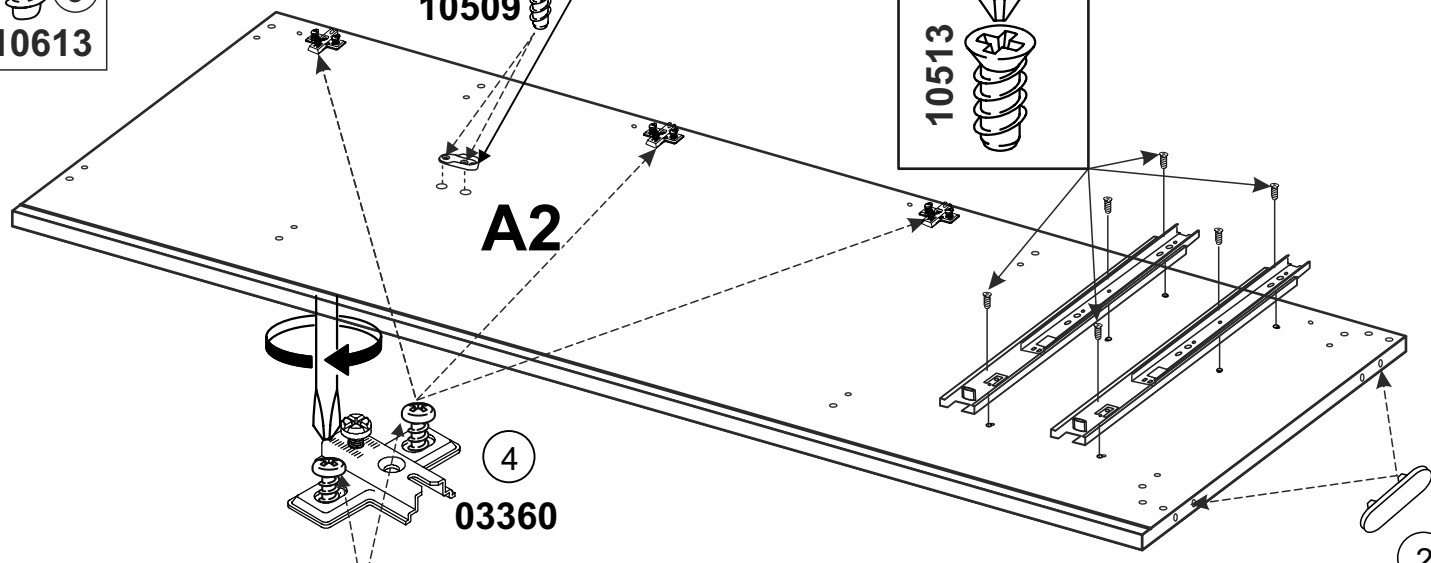
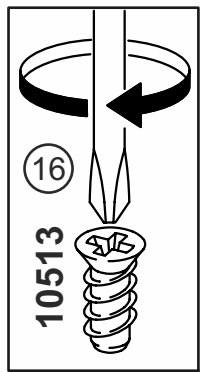
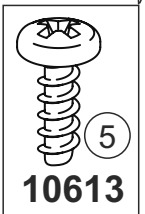
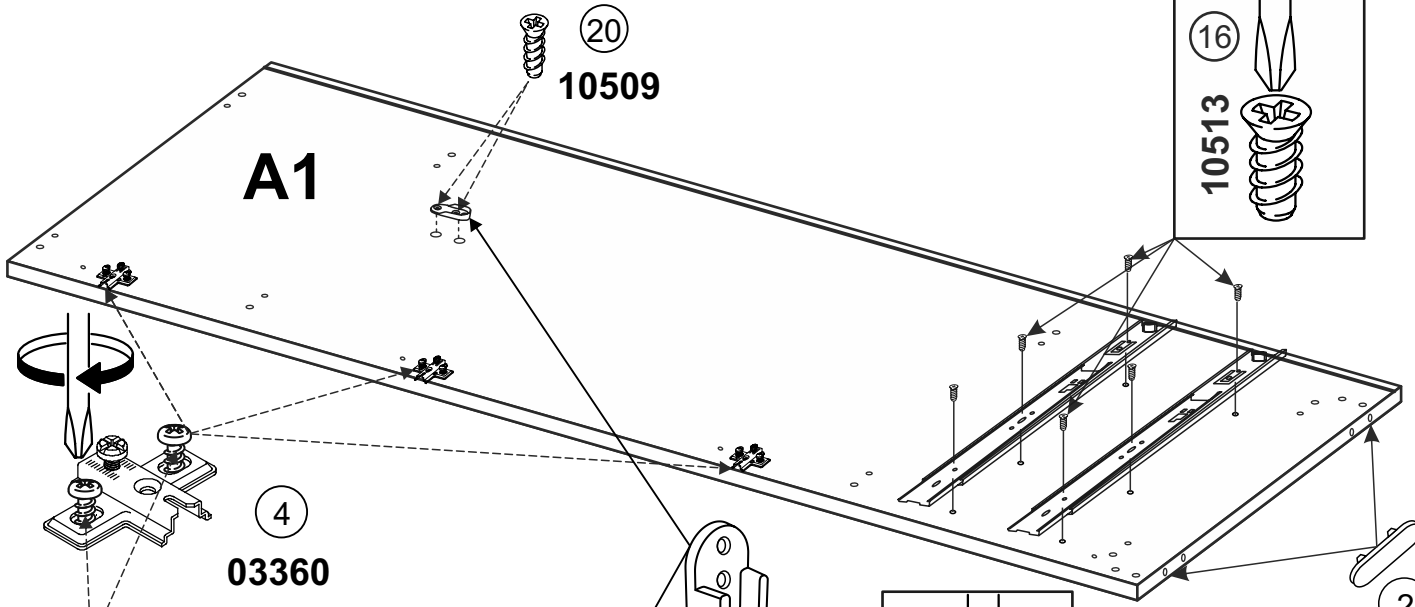
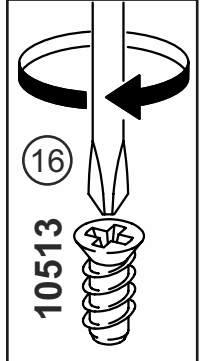
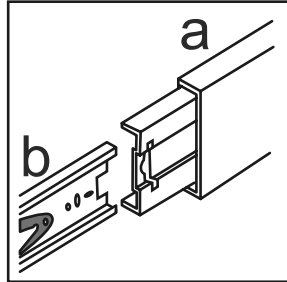
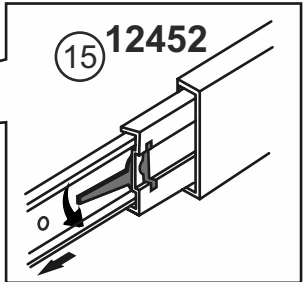
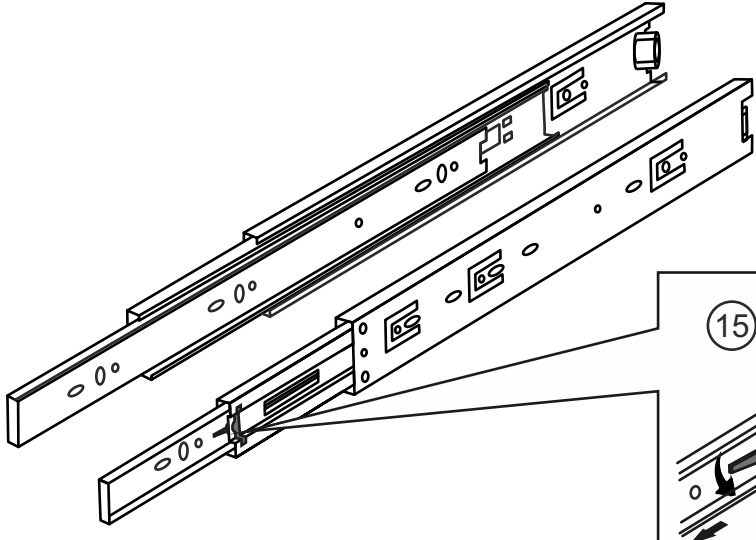

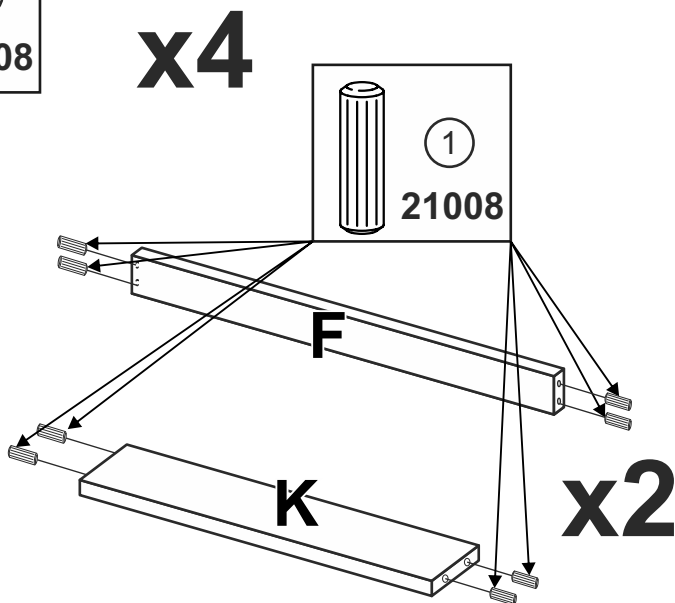
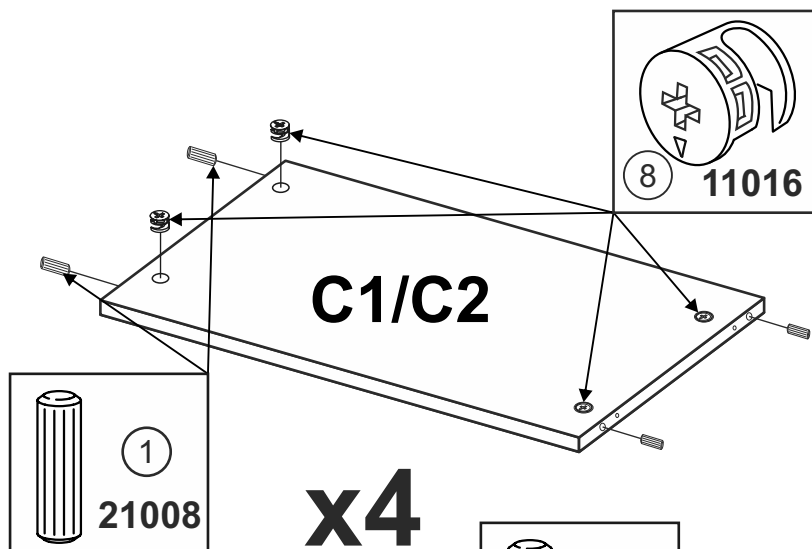
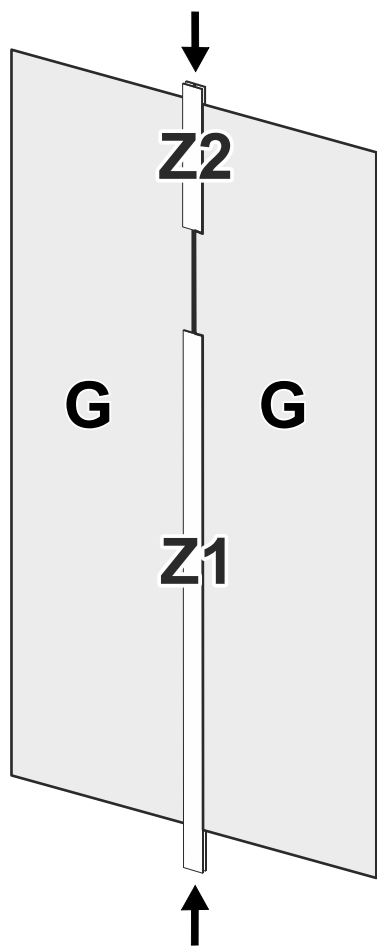
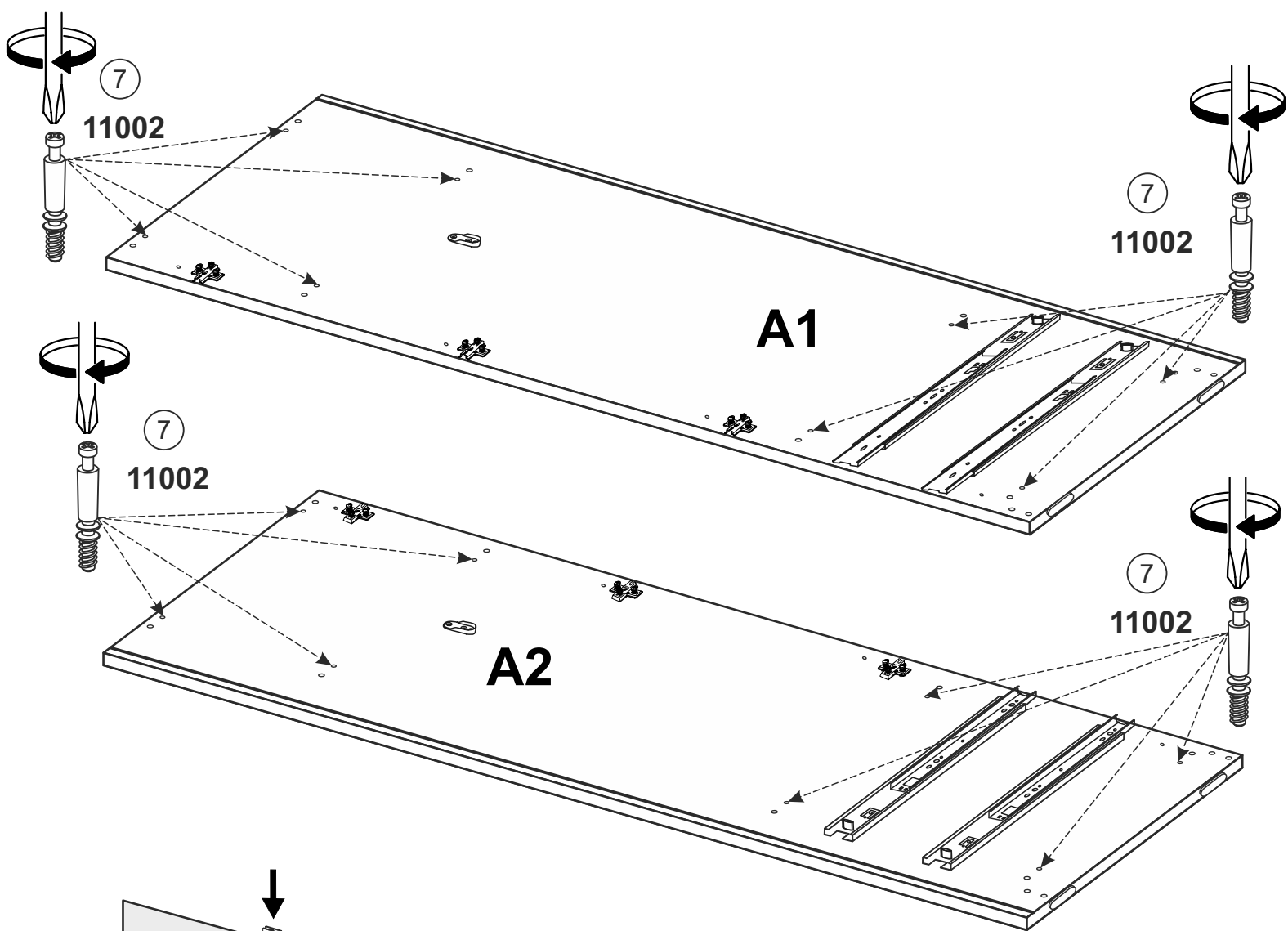

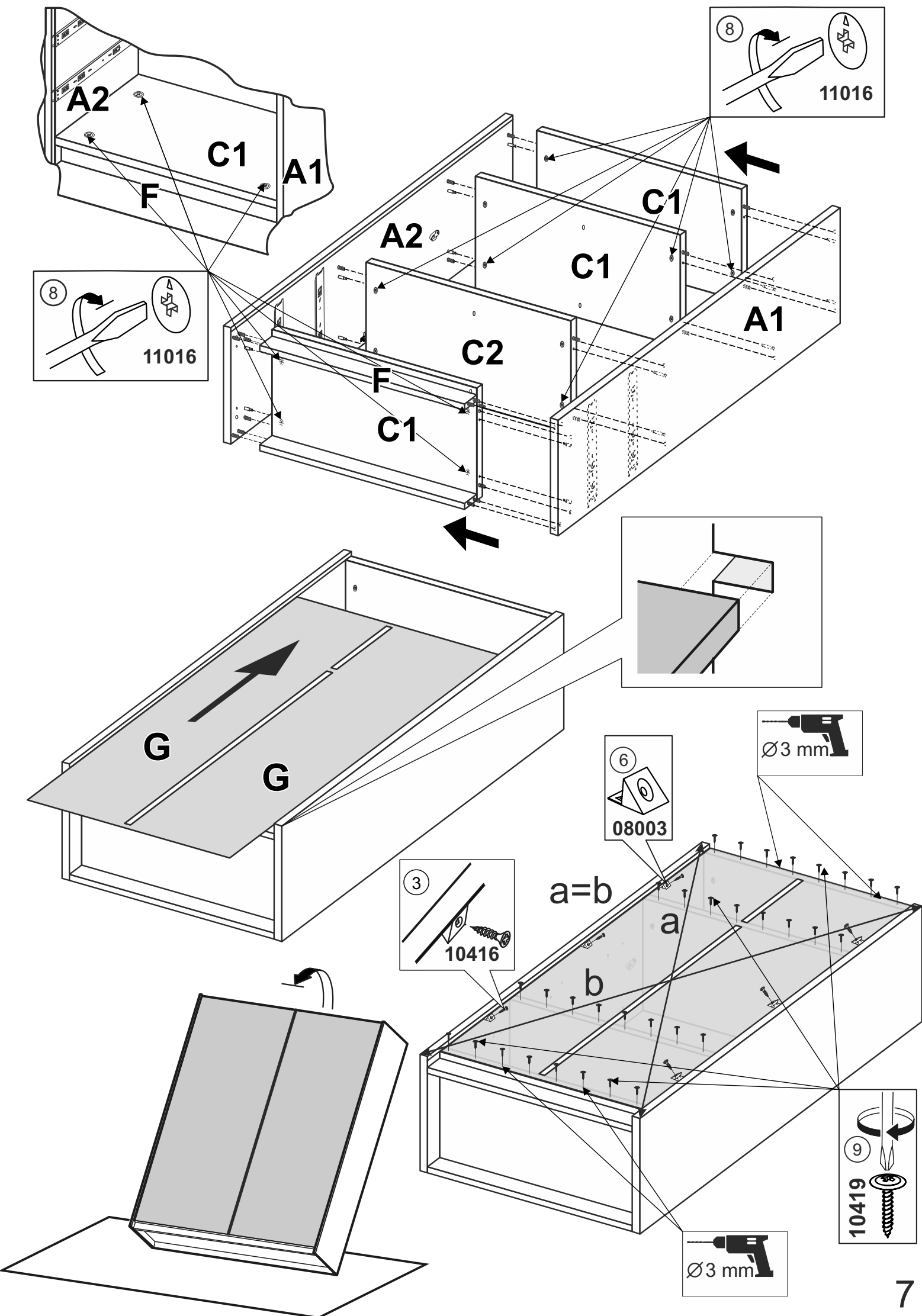

8  
11016

8  
11016

Ø3 mm

6  
08003

3  
10416

9  
10419

Ø3 mm

