

100, 150

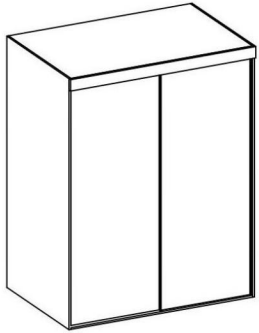

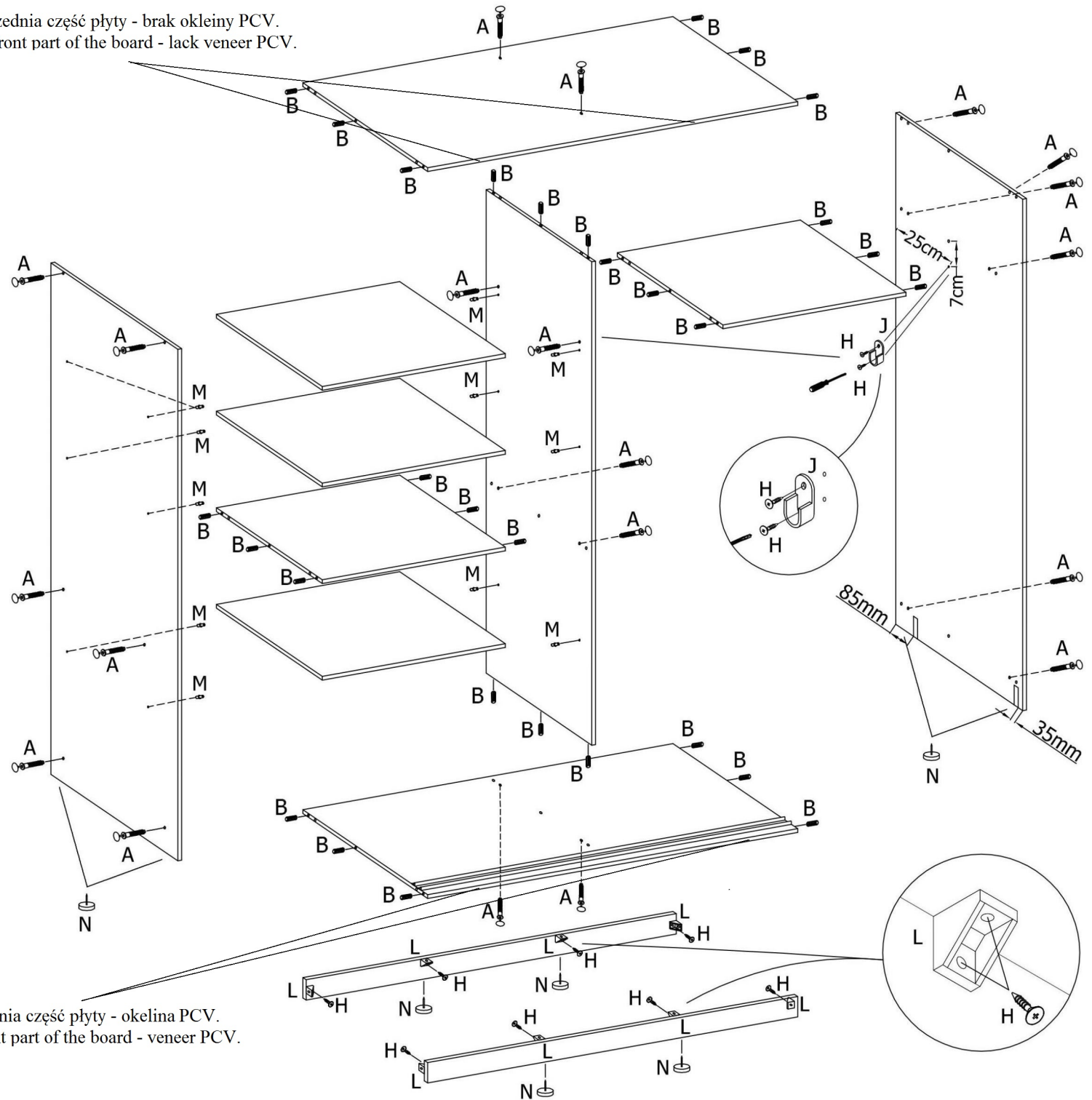











Przednia część płyty - brak okleiny PCV.  
The front part of the board - lack veneer PCV.



Przednia część płyty - okelina PCV.  
The front part of the board - veneer PCV.



			
20	28	1	100-110
			
4	4	64	2
			
1	8	12	8
			
4			

100, 150

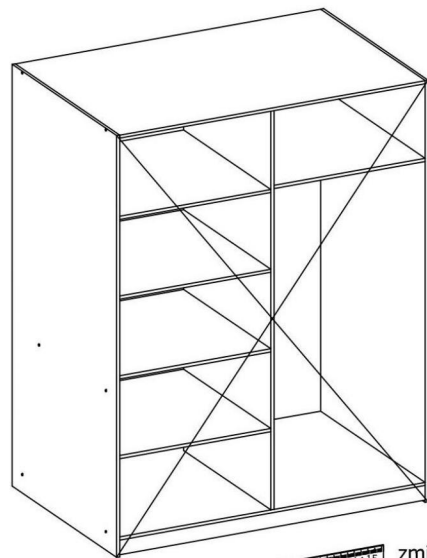
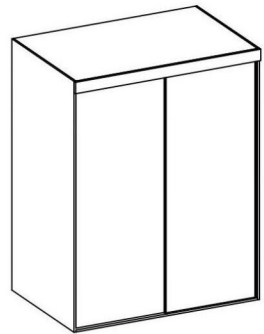

0 1 2 3 4 5 6 7 8 9 10 11 12 13 14 15 **zmiar przekatną**

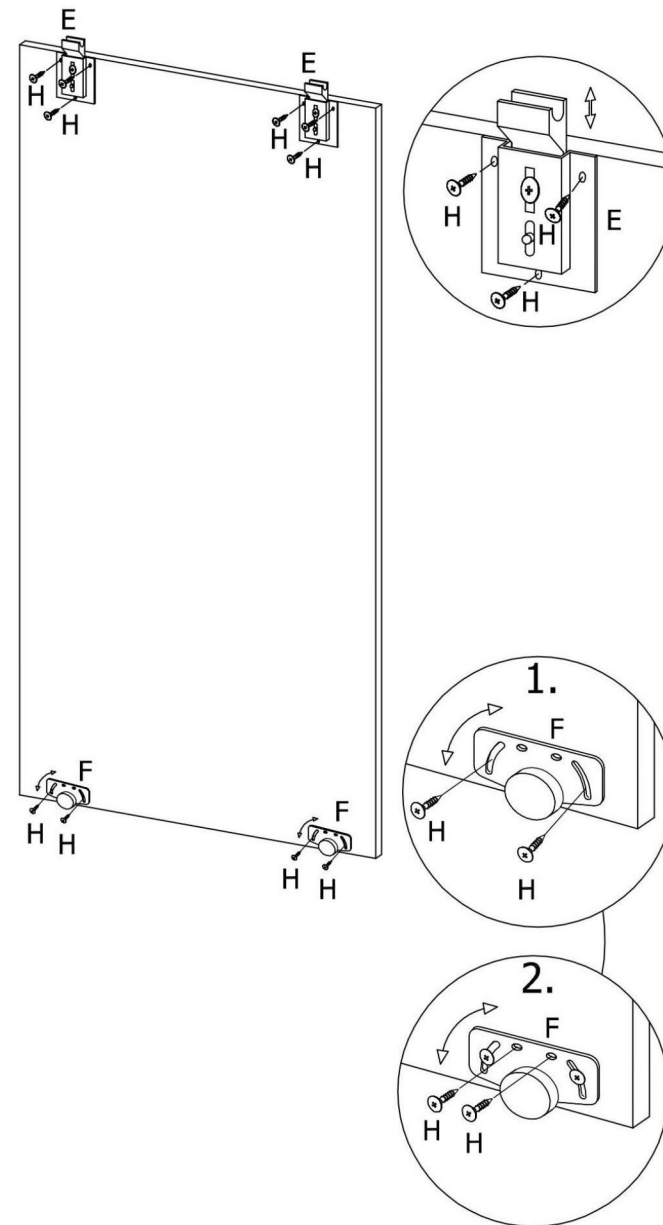
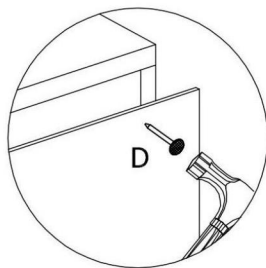
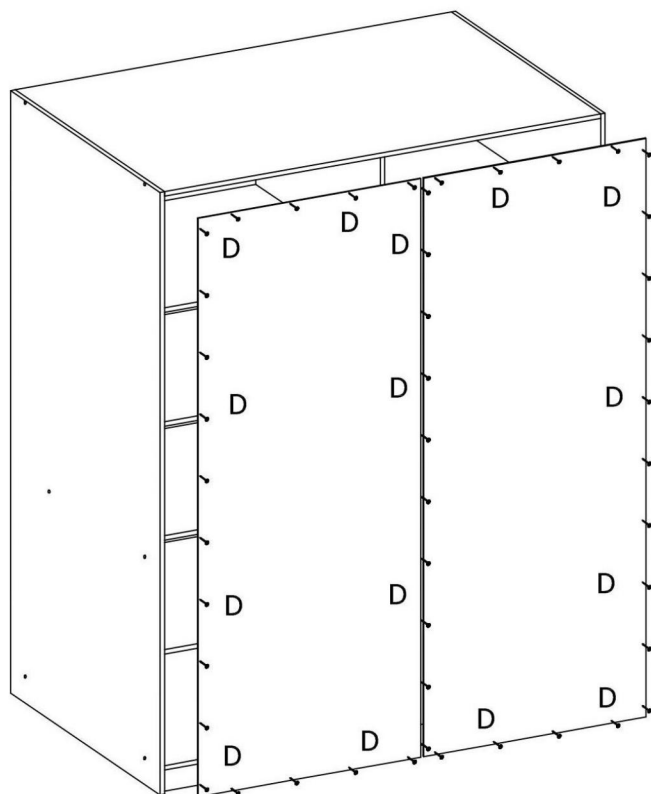

100, 150

