

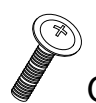









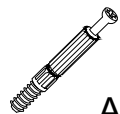
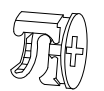



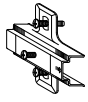
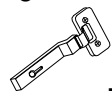



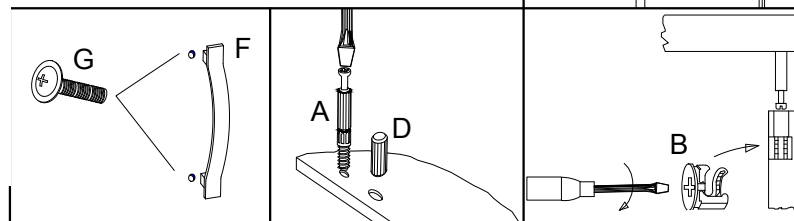
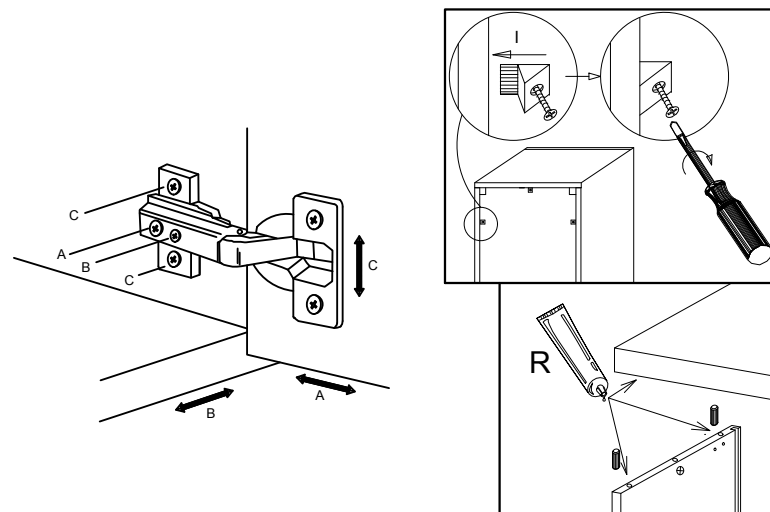
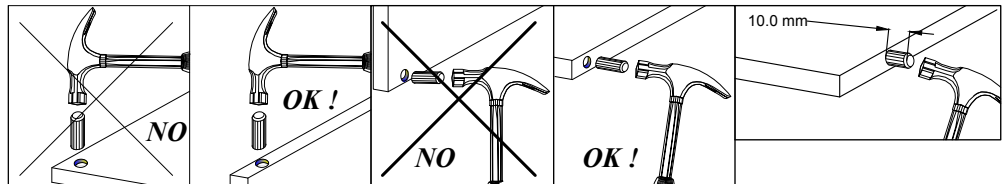
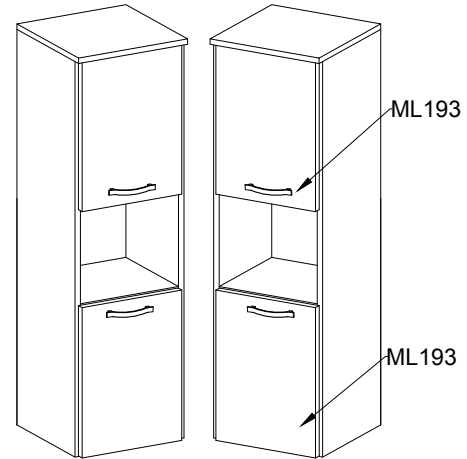
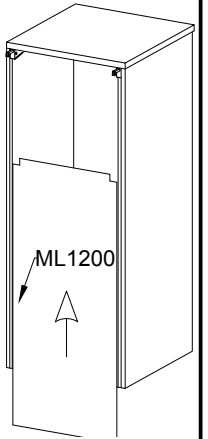
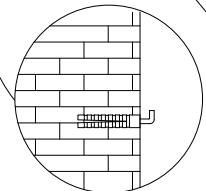
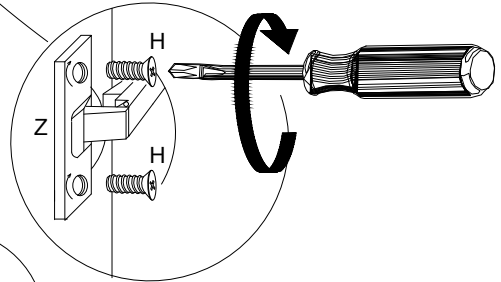
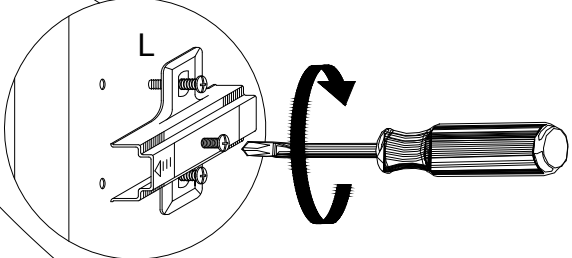
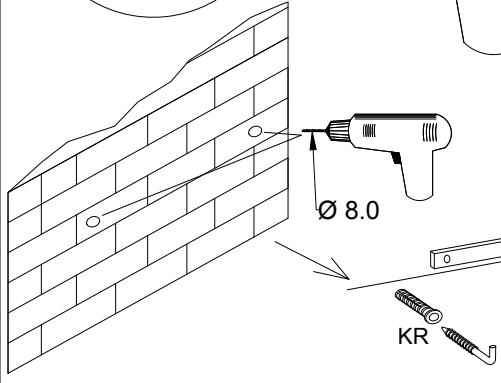
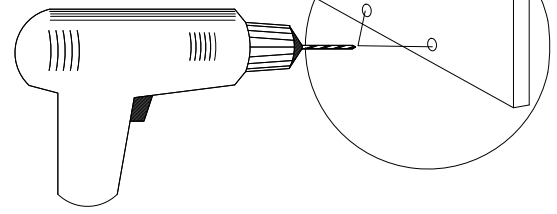
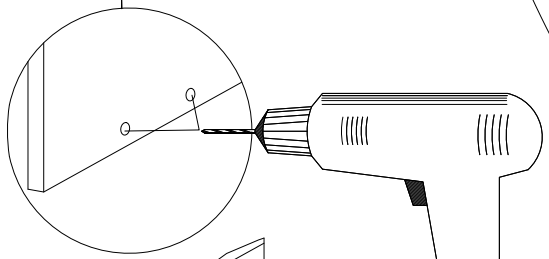
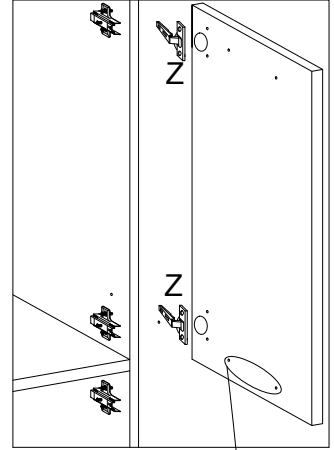
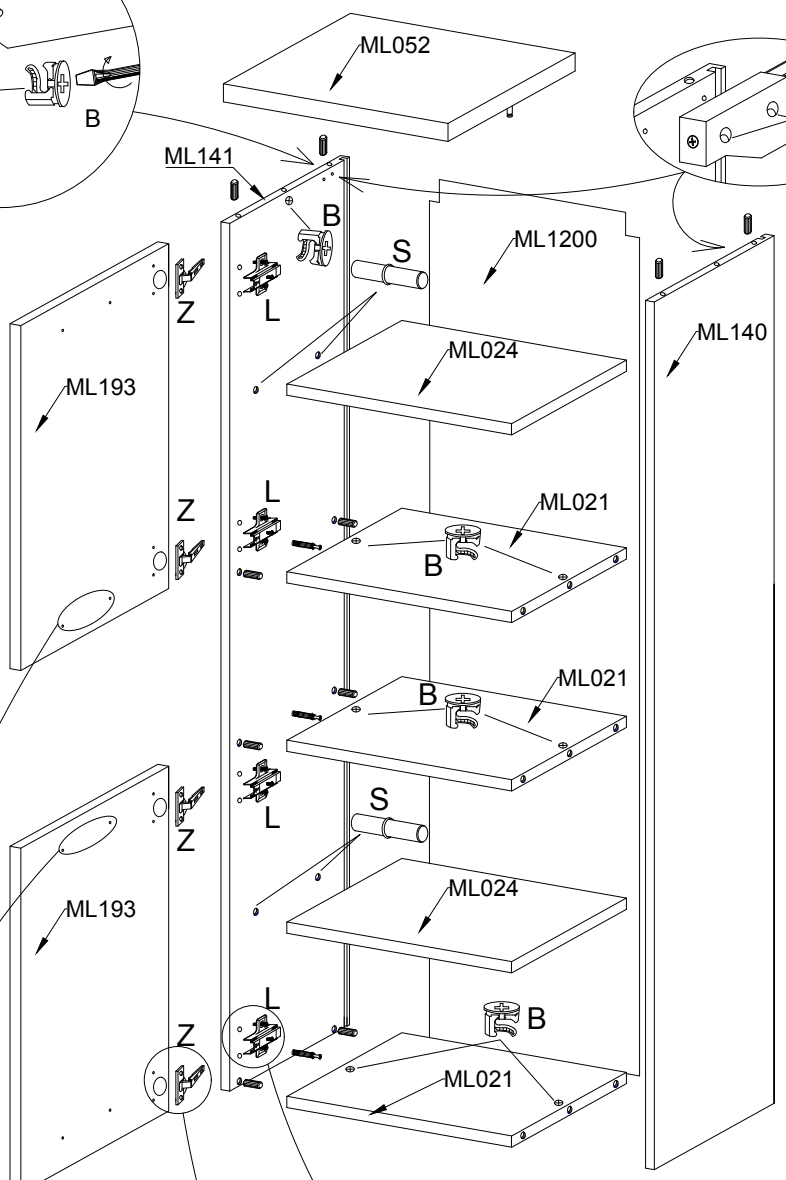
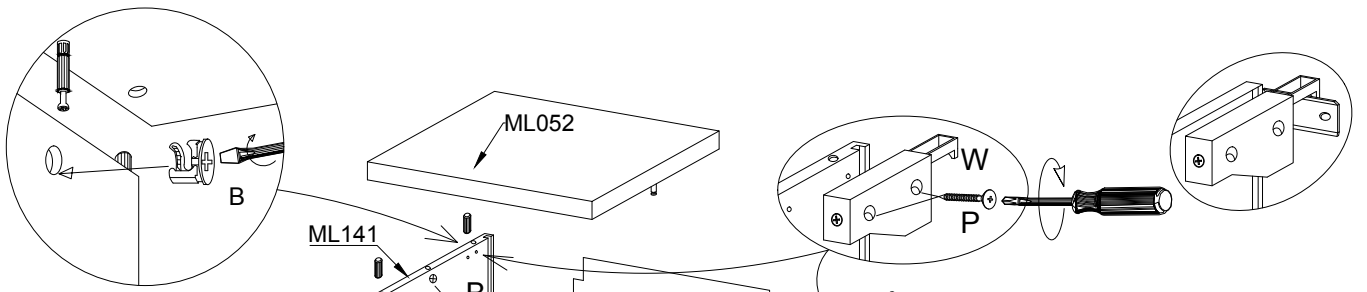
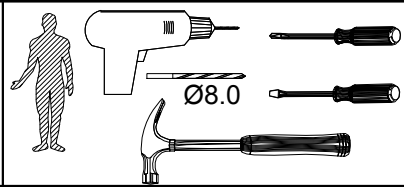

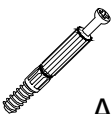

 W	 F	 M4.0X20	 8.0X30	 A	 B	 R
2	2	4	16	8	8	1
 P	 H	 L	 "0"	 S	 I	 KR
4	8	4	4	8	6	2



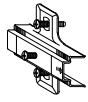
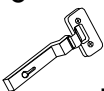



 W	 F	M4.0X20  G	8.0X30  D	 A	 B
2	2	4	14	8	8
4.0X30  P	6.3x13  H	 L	"0"  Z	4.0x25  V	 KR
4	8	4	4	2	4
 S	 U	 Y1	3.0X15  H1		
3	1	2	4		

