

NORDI

NWT90

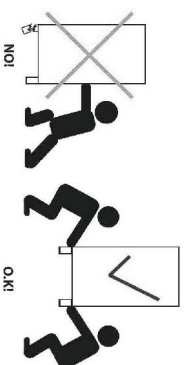
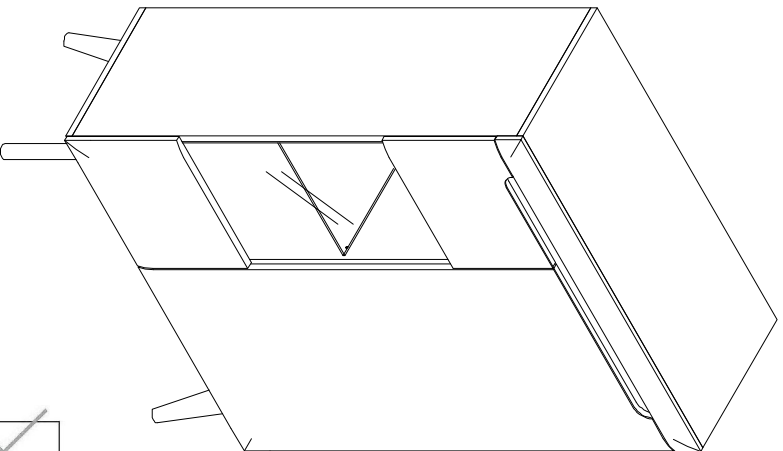

31.8.2017

- D** Montageanleitung
- FR** Notice de montage
- NL** Handleiding voor de montage
- CZ** Montážní návod
- HU** Szerelési útmutató
- TR** Montaj talimatı
- GB** Assembly Instructions
- IT** Istruzioni di montaggio
- PL** Instrukcja montażu
- SK** Návod na montáž
- RO** Instrucțiunile de montaj
- RU** Инструкции по монтажу

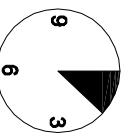

20 min.

1

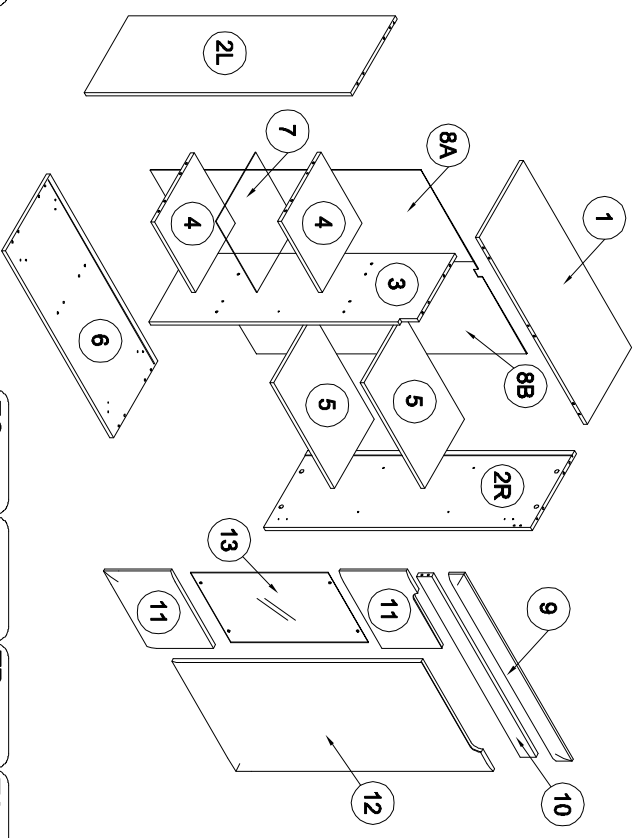

ZA X1	Z X23	HD X8	NGD X4	N X8	NA X1	TB X1	TA X1
B X23	A X27	H X10	R X5	PC X5	NC X4	ND X10	ZD X4
C X23	Z X23	HD X8	NGD X4	N X14	X X14	ZE X4	Z X8
B X23	A X27	H X10	R X5	PC X5	NC X4	ND X10	ZD X4
ZA X1	Z X23	HD X8	NGD X4	N X8	NA X1	TB X1	TA X1
B X23	A X27	H X10	R X5	PC X5	NC X4	ND X10	ZD X4
C X23	Z X23	HD X8	NGD X4	N X14	X X14	ZE X4	Z X8
B X23	A X27	H X10	R X5	PC X5	NC X4	ND X10	ZD X4

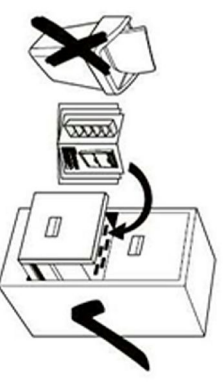
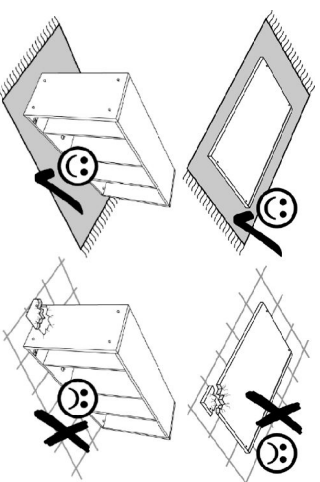

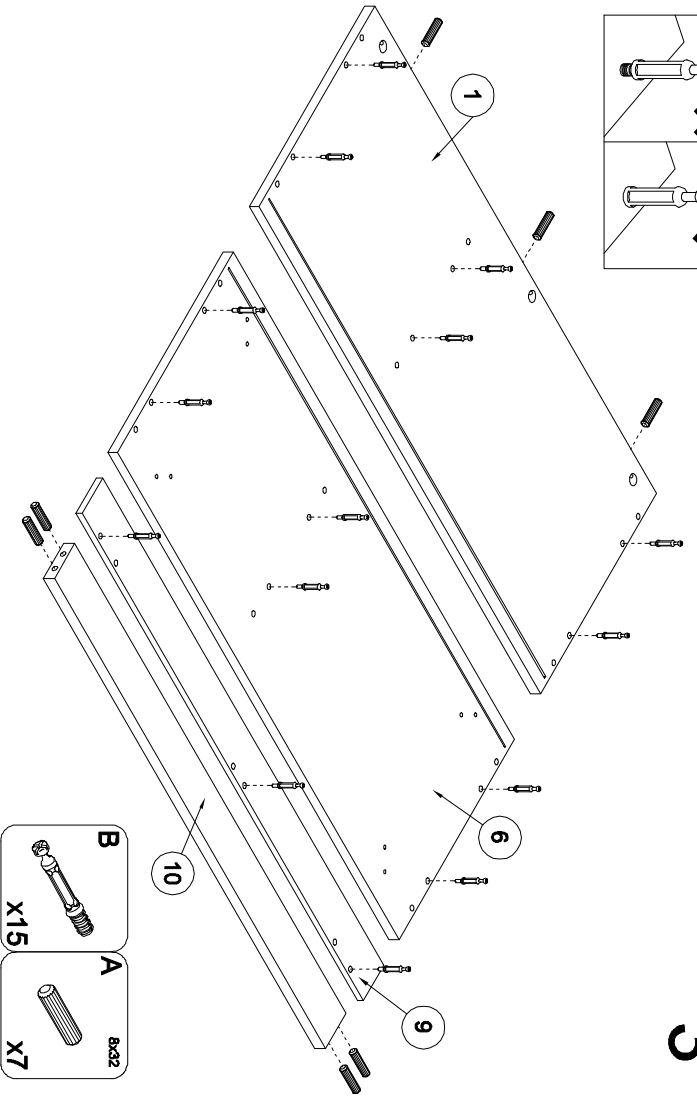
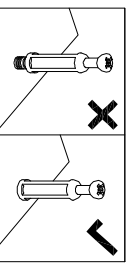

2

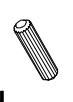

- | | |
|-----------------------------------------------------------------------------------|------------------------------------------------------------------------------------|
| B | A |
|  |  |
| X15 | 8x32
X7 |

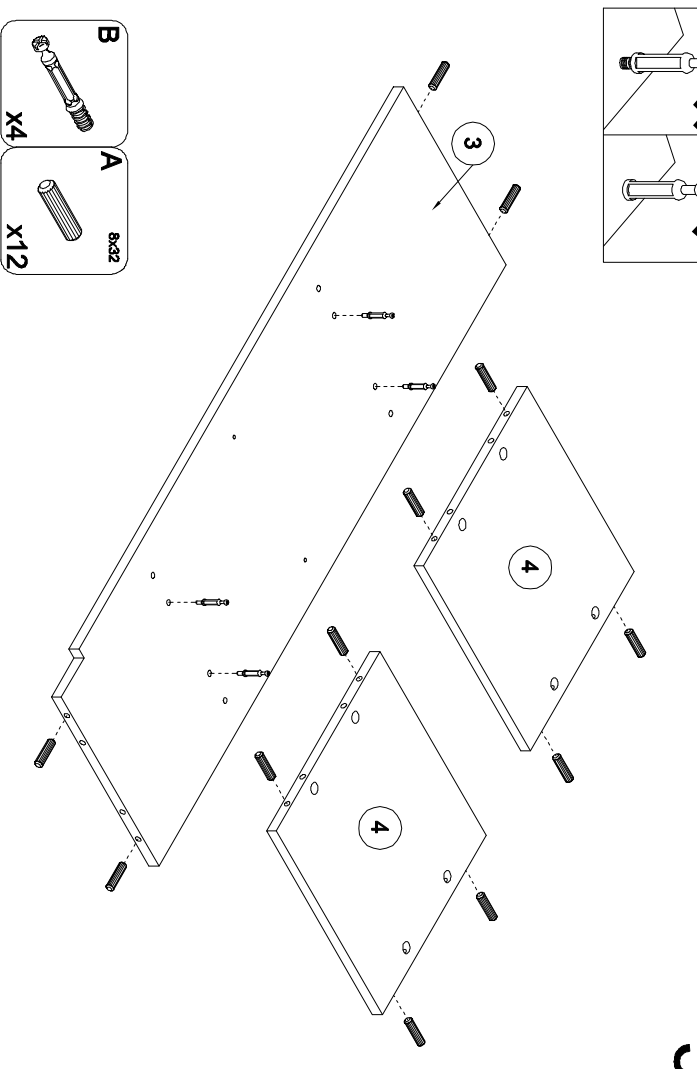
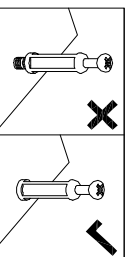



3

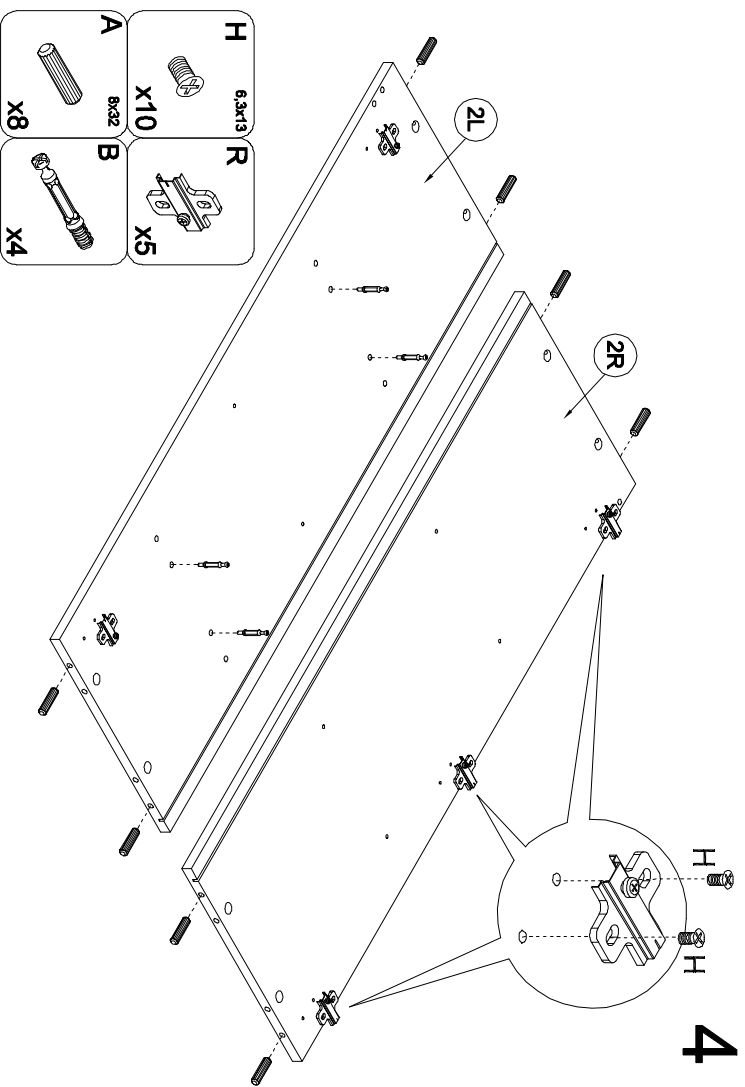

- | | |
|-------------------------------------------------------------------------------------|-------------------------------------------------------------------------------------|
| B | A |
|  |  |
| X4 | 8x32
X12 |

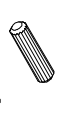



4

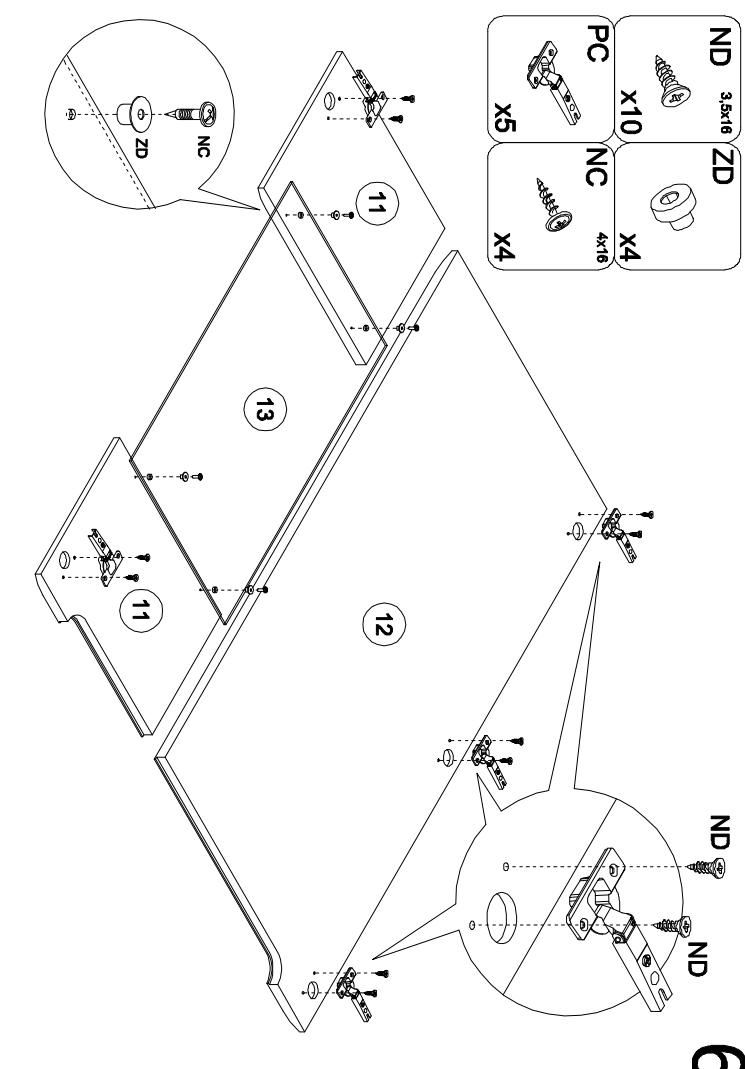

- | | |
|----------------------------------------------------------------------------------|-----------------------------------------------------------------------------------|
| A | H |
|  |  |
| X8 | 6.3x13
X10 |
| B | R |
|  |  |
| X4 | X5 |

4



- | | |
|-------------------------------------------------------------------------------------|-------------------------------------------------------------------------------------|
| ND | ZD |
|  |  |
| 3.5x16
X10 | X4 |
| PC | NC |
|  |  |
| X5 | 4x16
X4 |

5

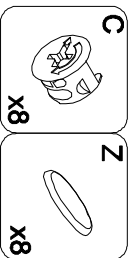
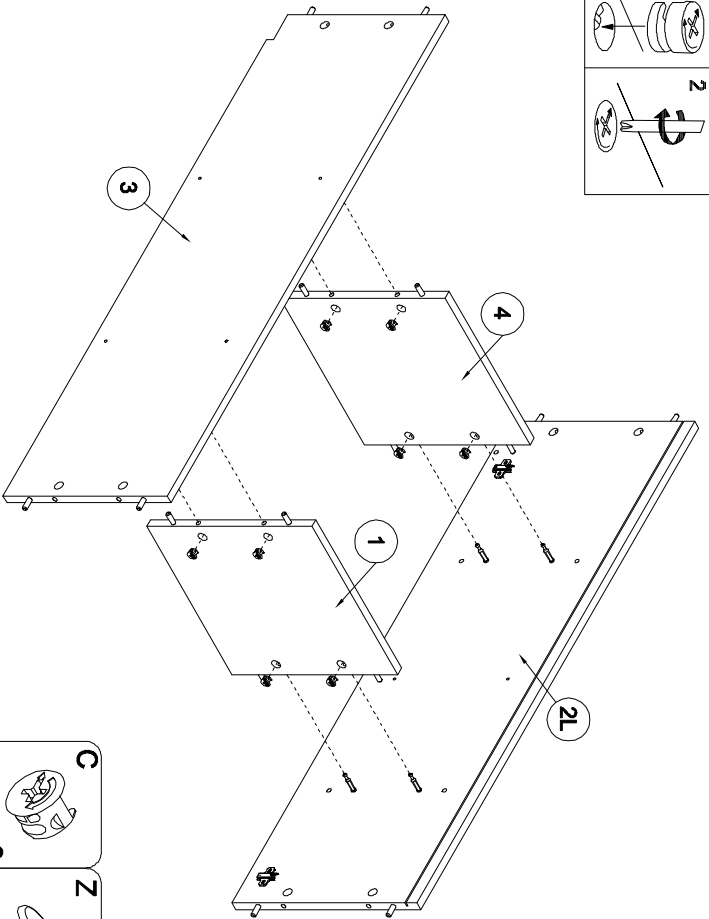
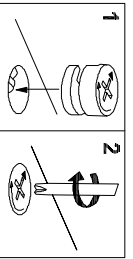

7

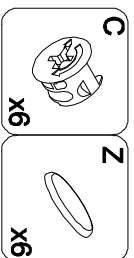
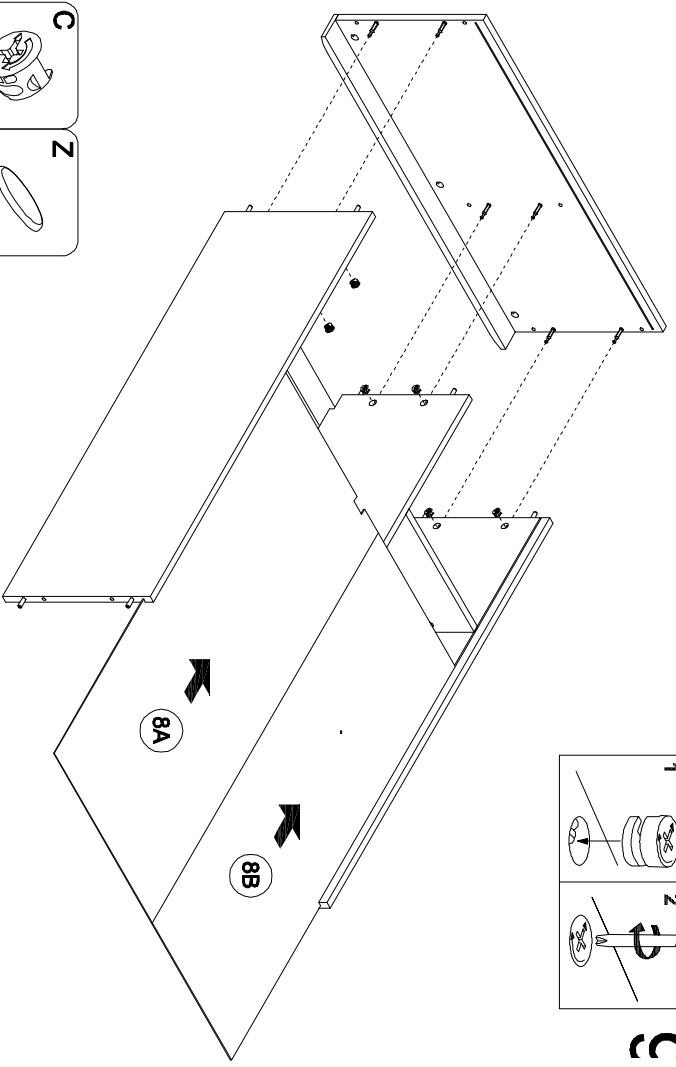
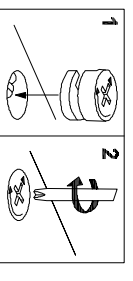

9

8

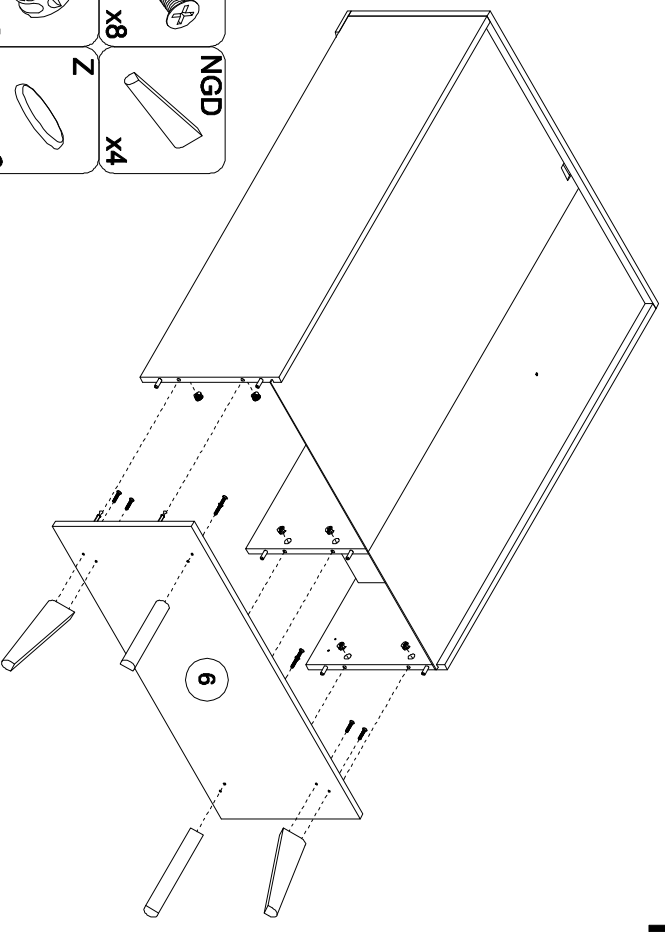
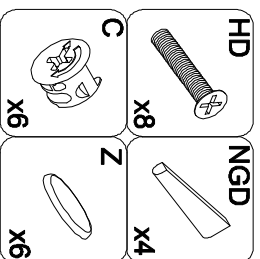
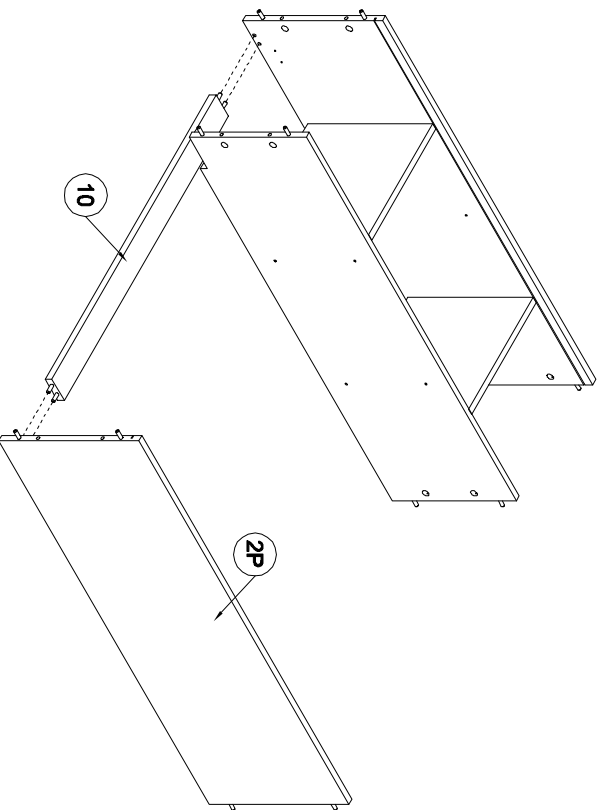

10

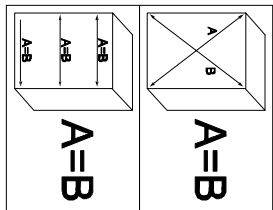

11

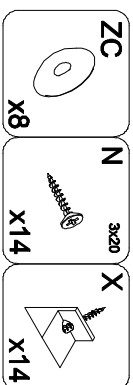
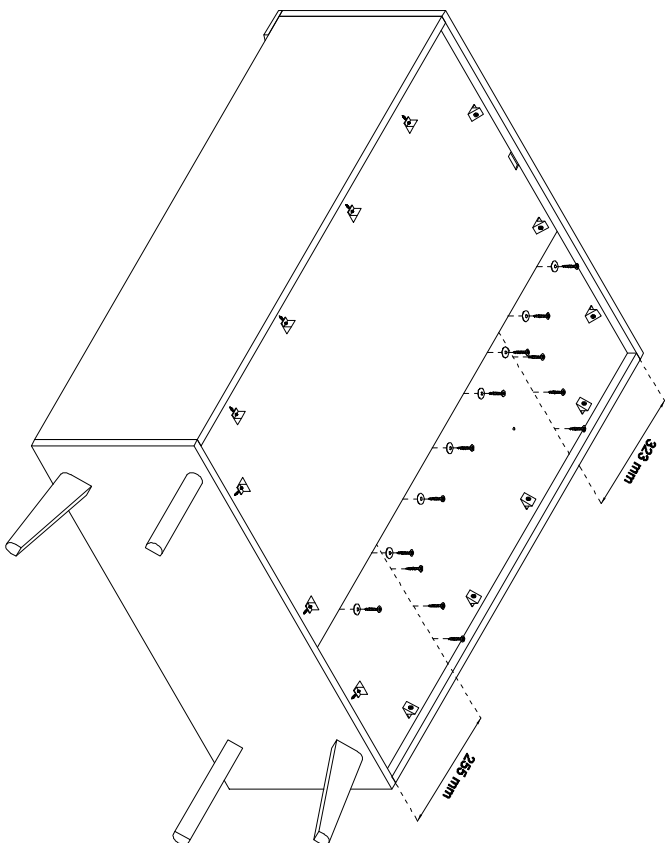

12

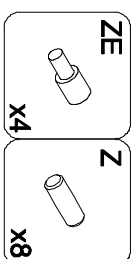
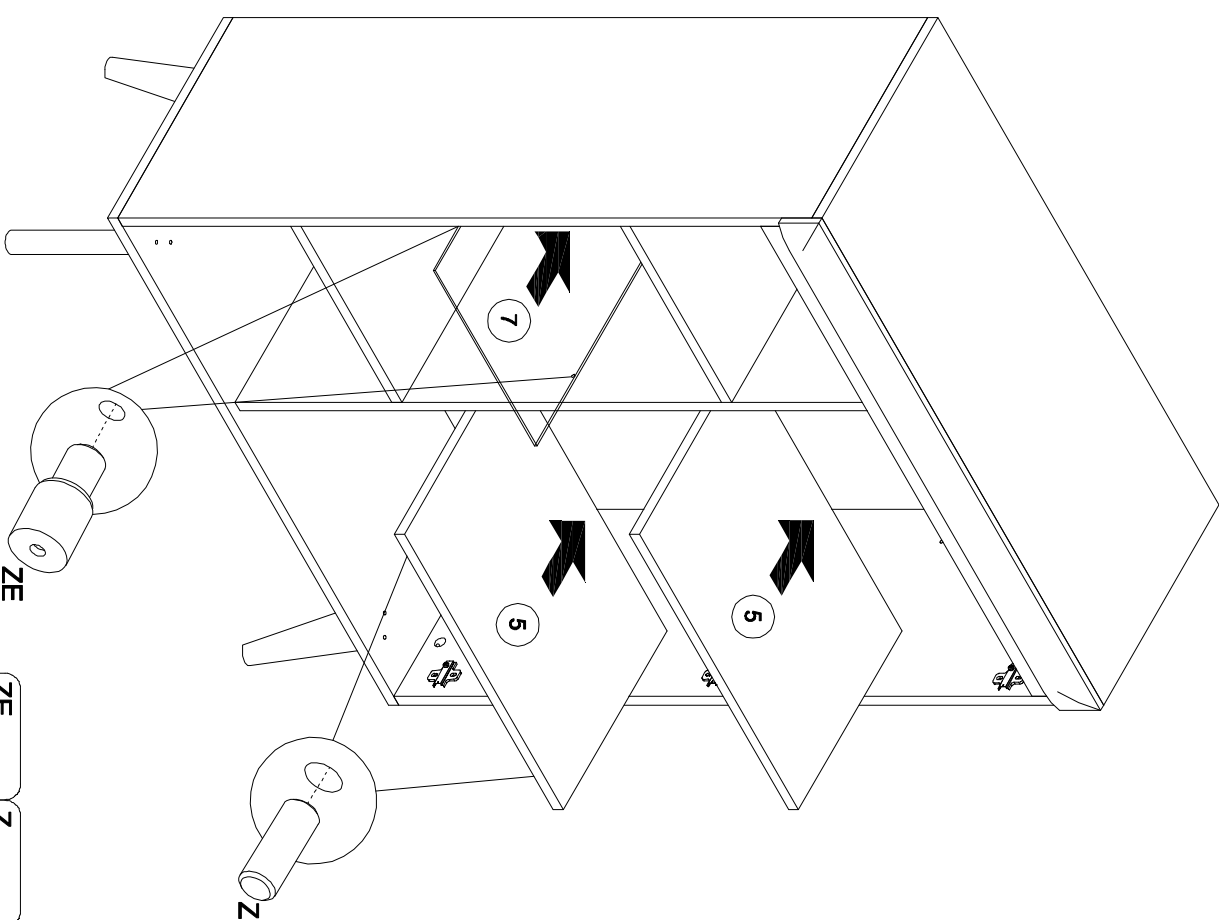

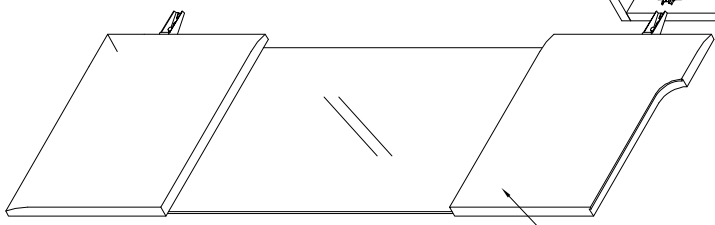
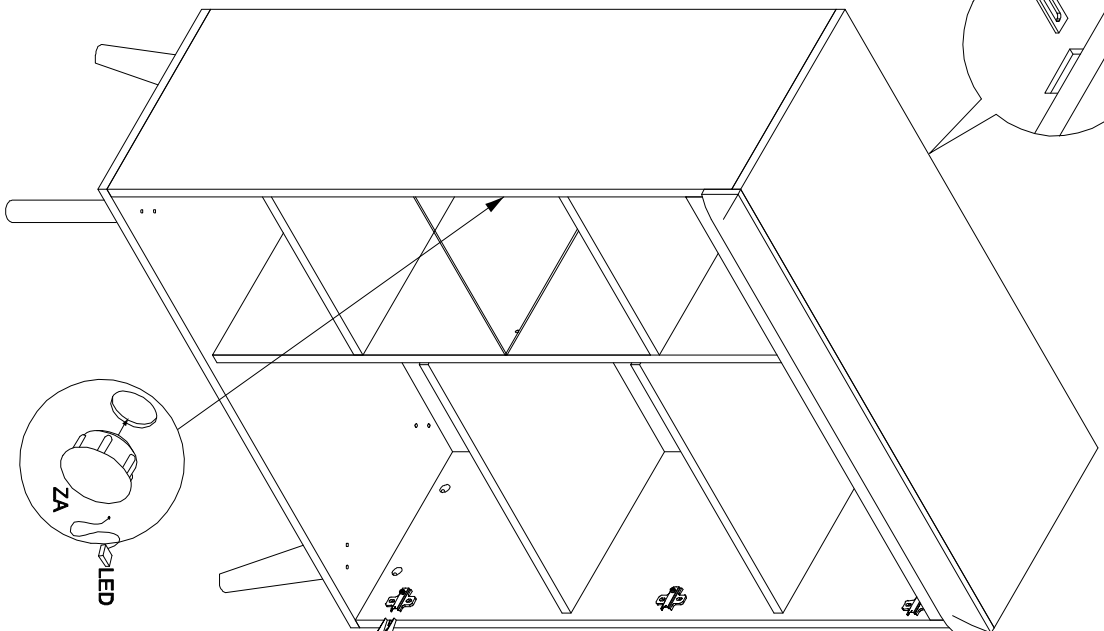
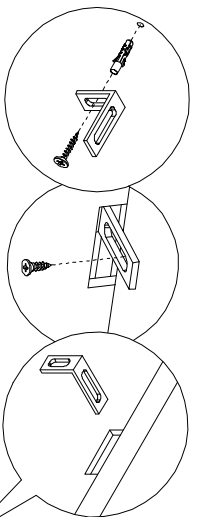
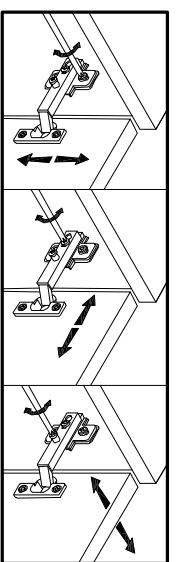

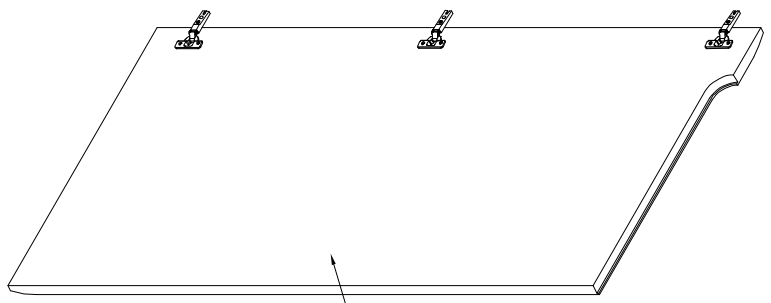

11



12

- NA 4x13 x1 
- TB x1 
- TA x1 
- ZA x1 