

FALCO

FK150

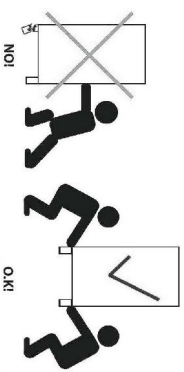
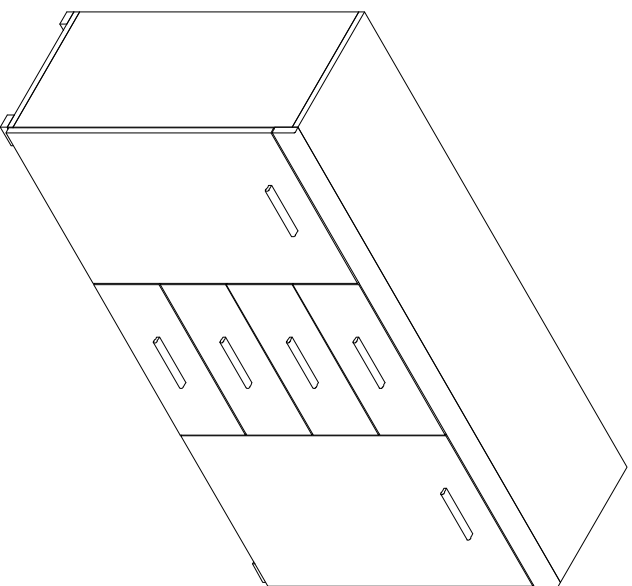

31.6.2017

- D** Montageanleitung
- FR** Notice de montage
- NL** Handleiding voor de montage
- CZ** Montážní návod
- HU** Szerelési útmutató
- TR** Montaj talimatı
- GB** Assembly Instructions
- IT** Istruzioni di montaggio
- PL** Instrukcja montażu
- SK** Návod na montáž
- RO** Instrucțiunile de montaj
- RU** Инструкции по монтажу

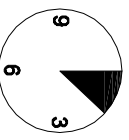
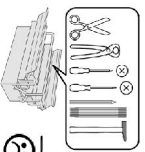

20 min.

1

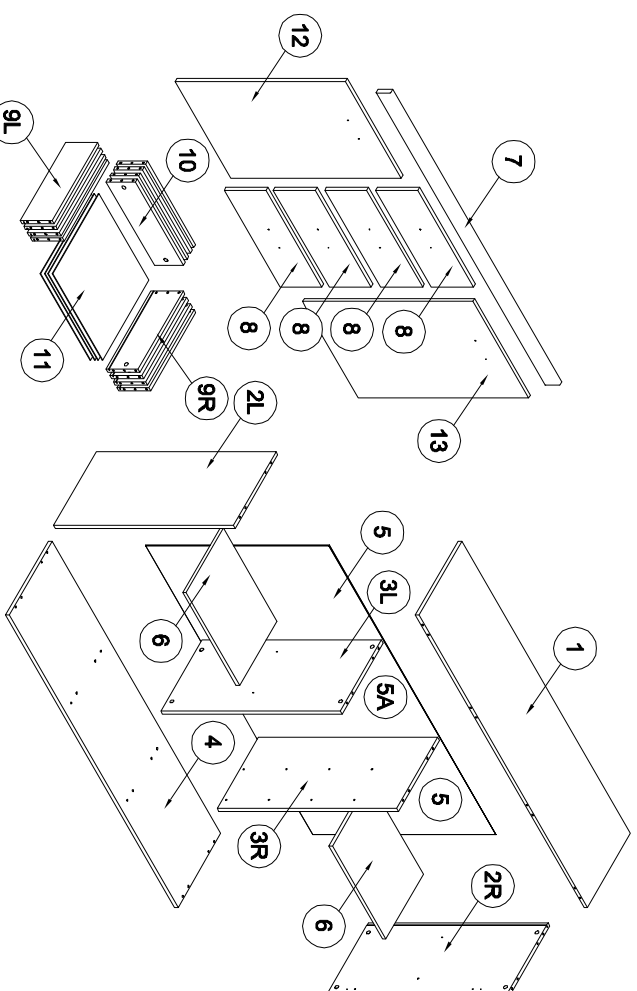

ZC x10	Y x6	W x6	YA x12	PC x4	NA x8	ND x24	C x36	Z x36
B x36	A x52	RPS x4	RC x4	H x8	NB x24	N x26	X x10	
	6x32		4x27	6.5x13	3.5x13	3x20		

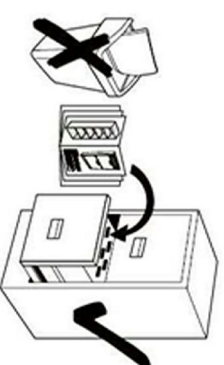
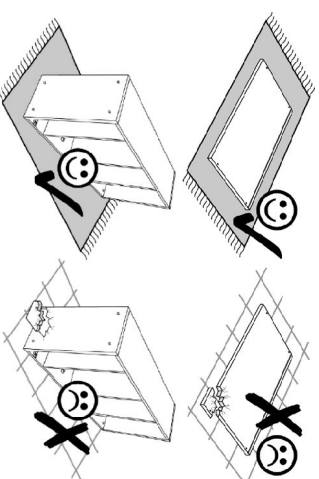

2

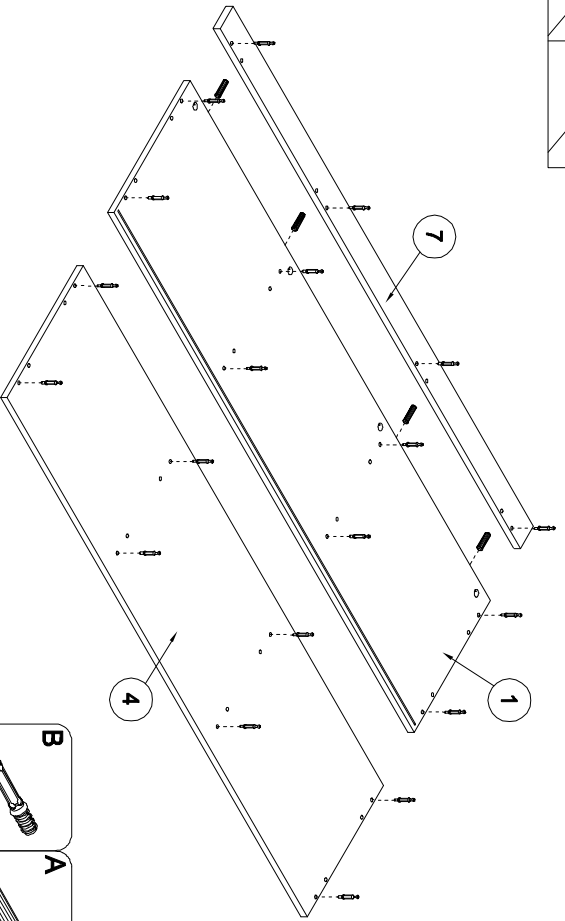
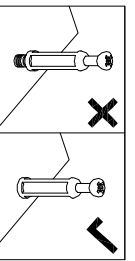

- B** X20
- A** 8x32 X4

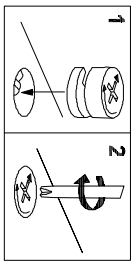

3

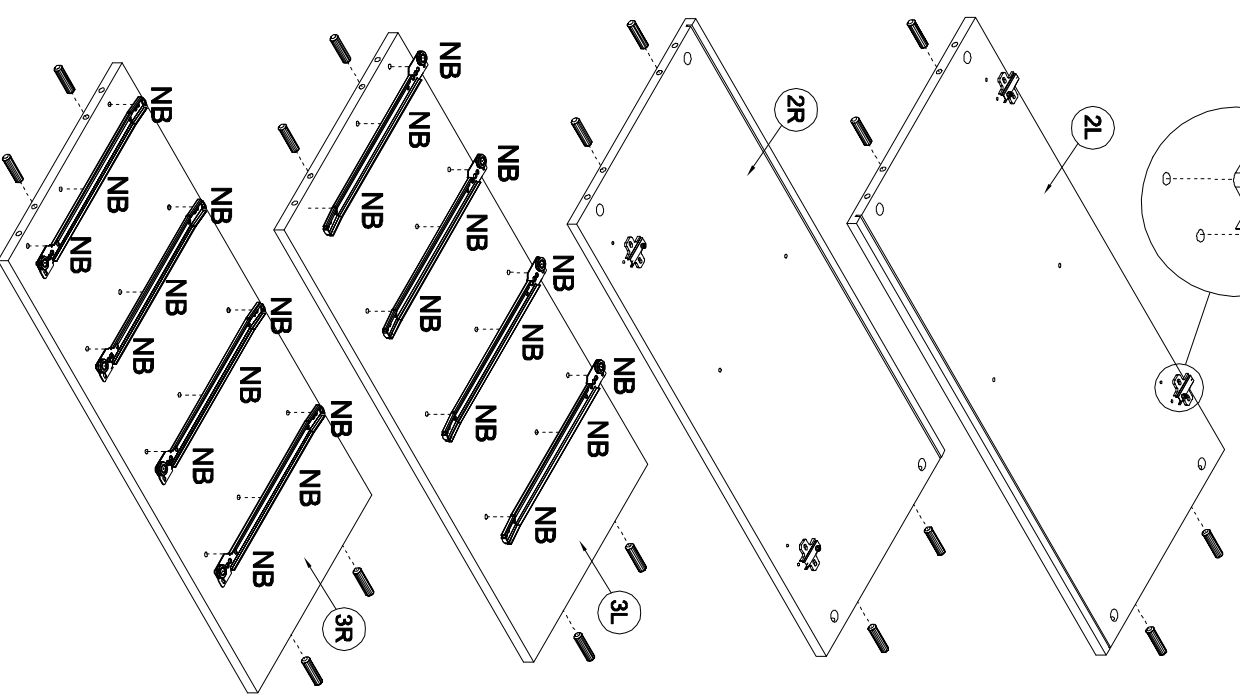
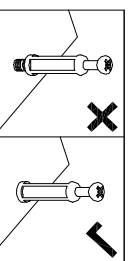

- RPS** X4
- A** 8x32 X4
- RC** X16
- H** 6.5x13 X4
- NB** 3.5x13 X8
- NB** 3.5x13 X24

4

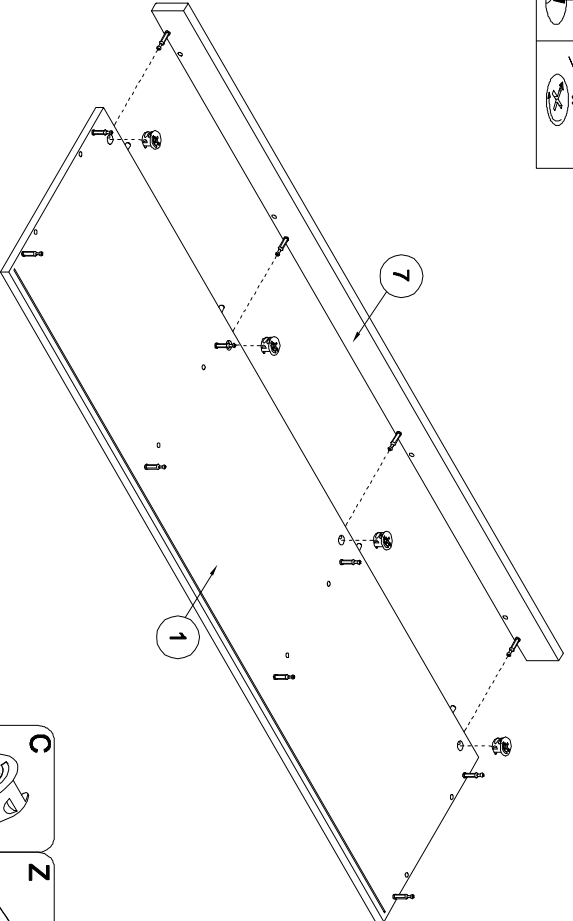



- C** X4
- Z** X4

5

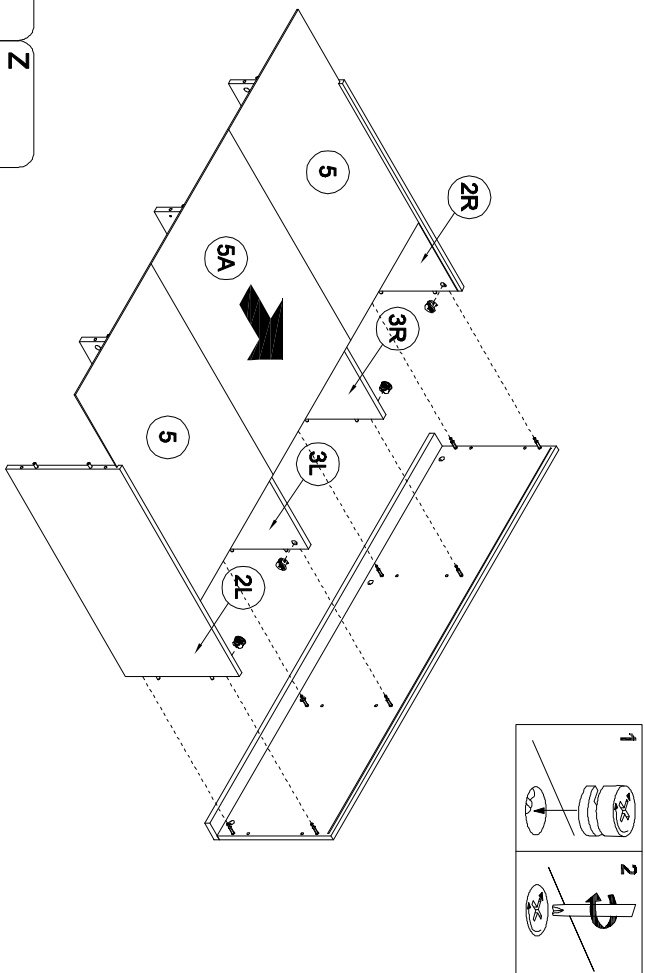

6



- C  X8
- Z  X8

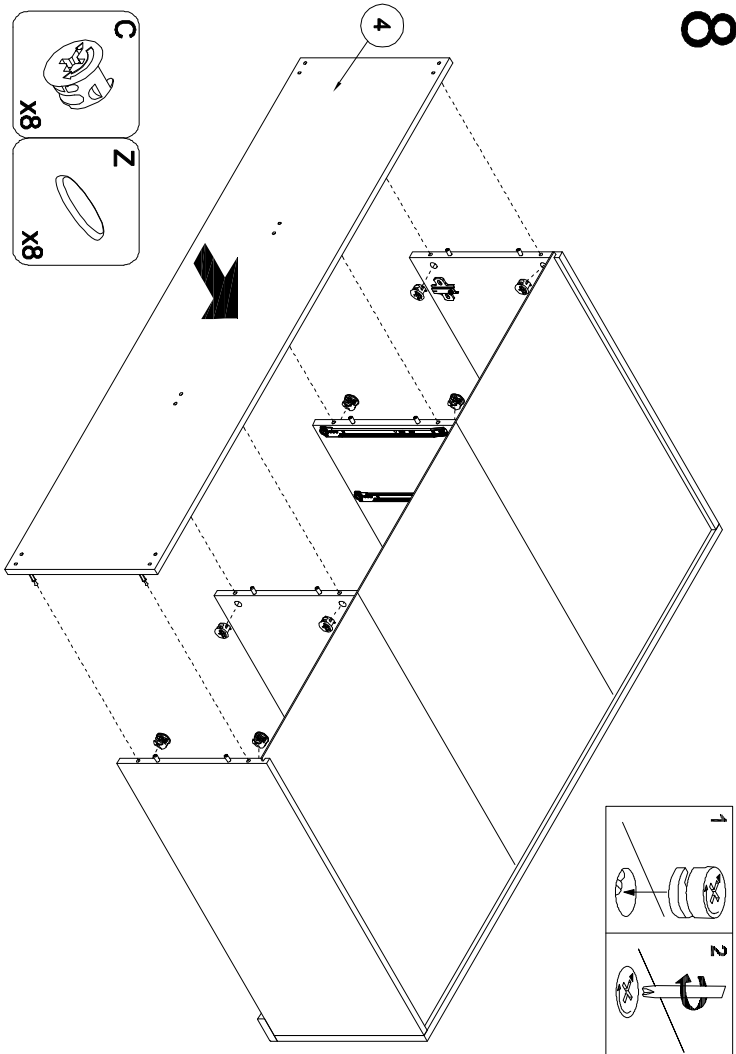

8



- C  X8
- Z  X8

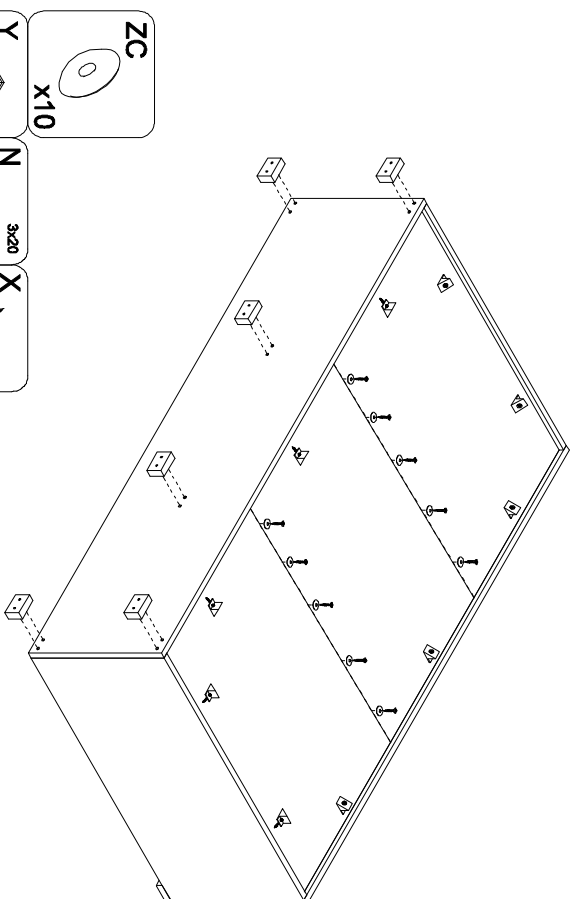

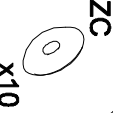

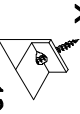
7

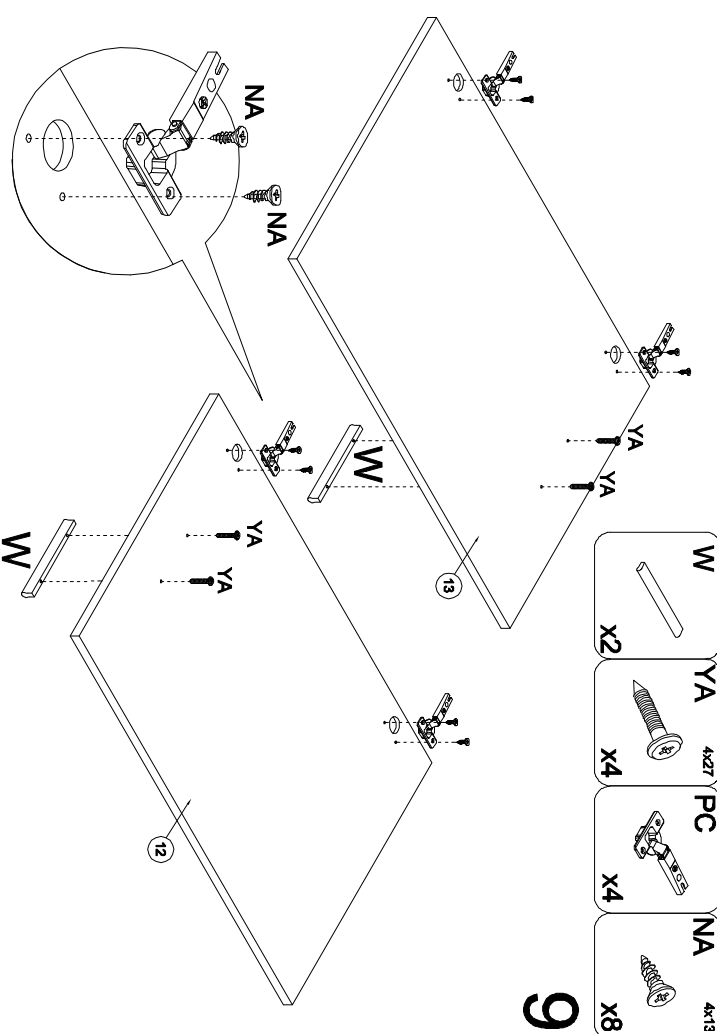

- ZC  X10
- Y  X6
- N  3x20 X10
- X  X10

9



- W  X2
- YA  4x27 X4
- PC  X4
- NA  4x13 X8

10

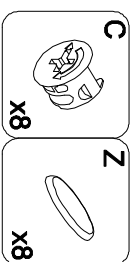
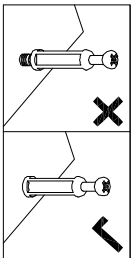
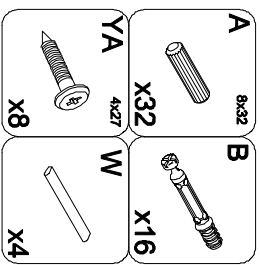
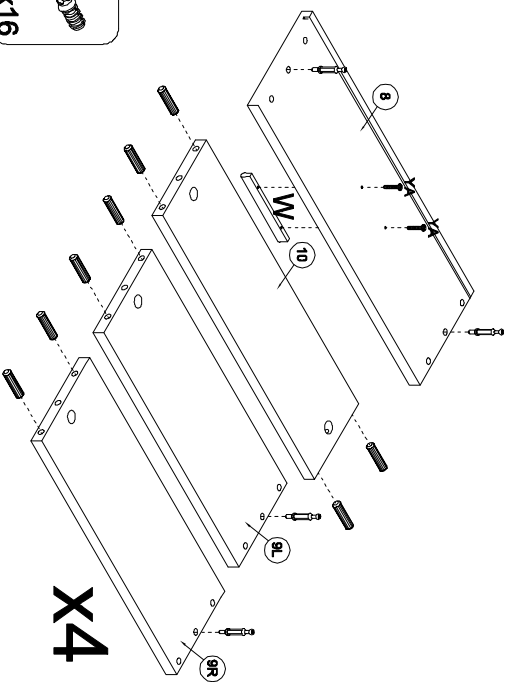

11

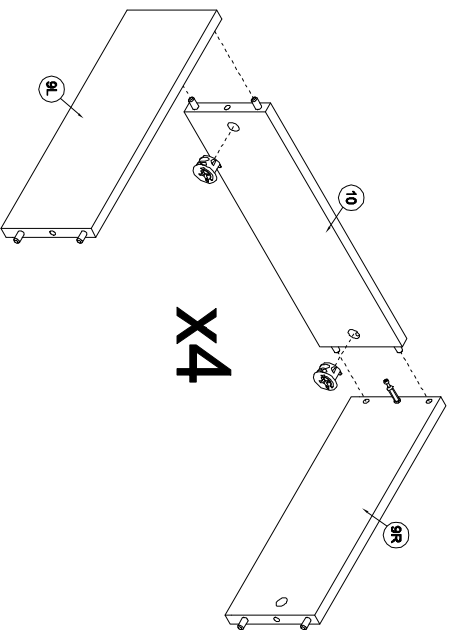

12

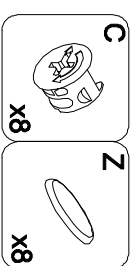
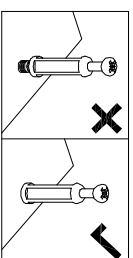
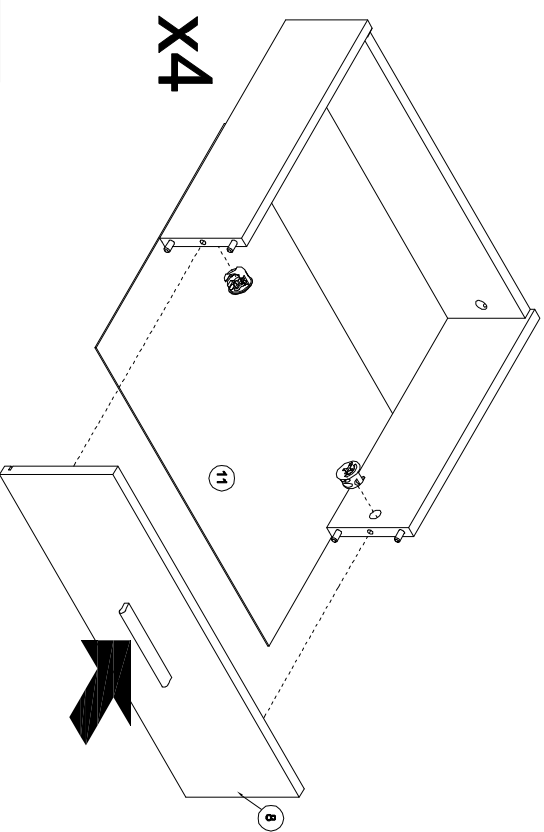

13

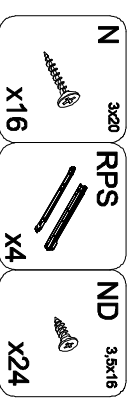
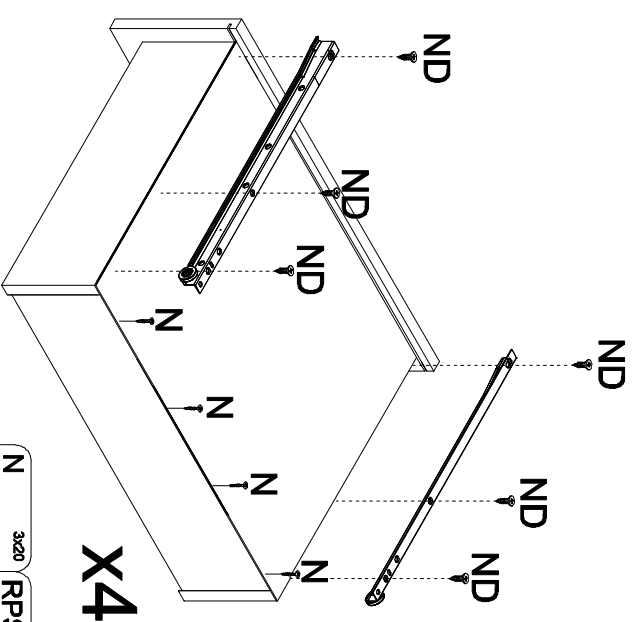

14

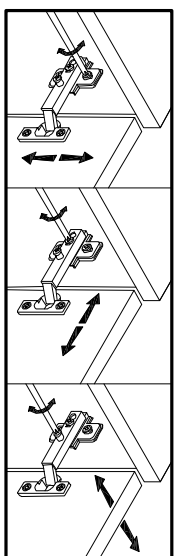
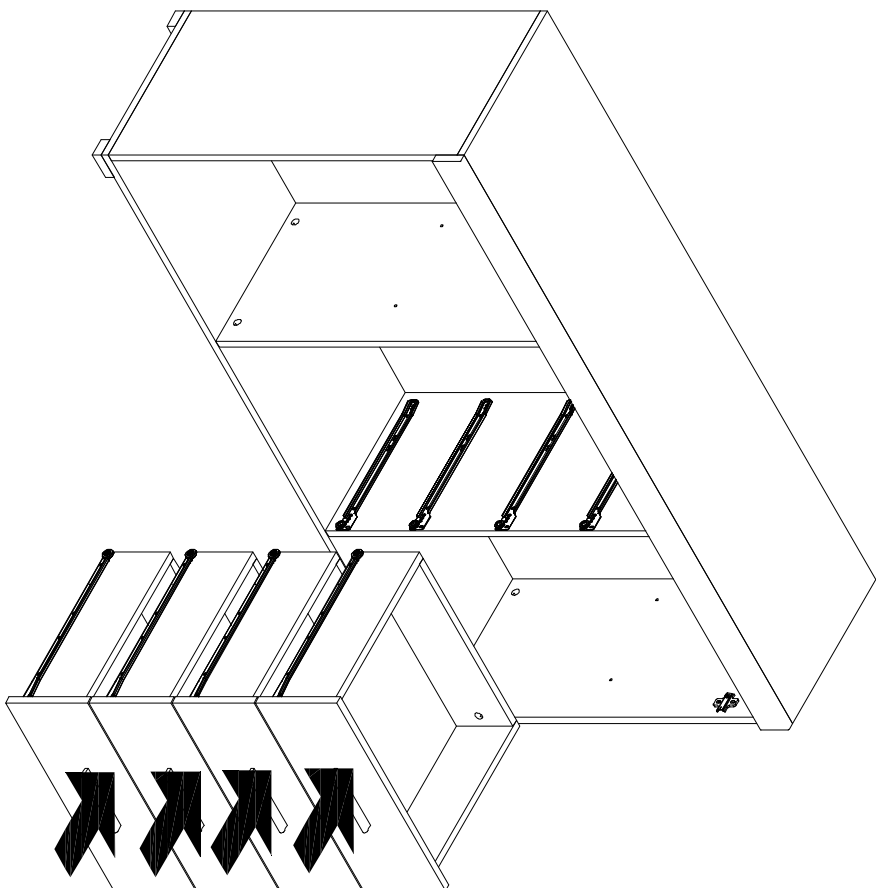

15

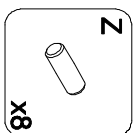
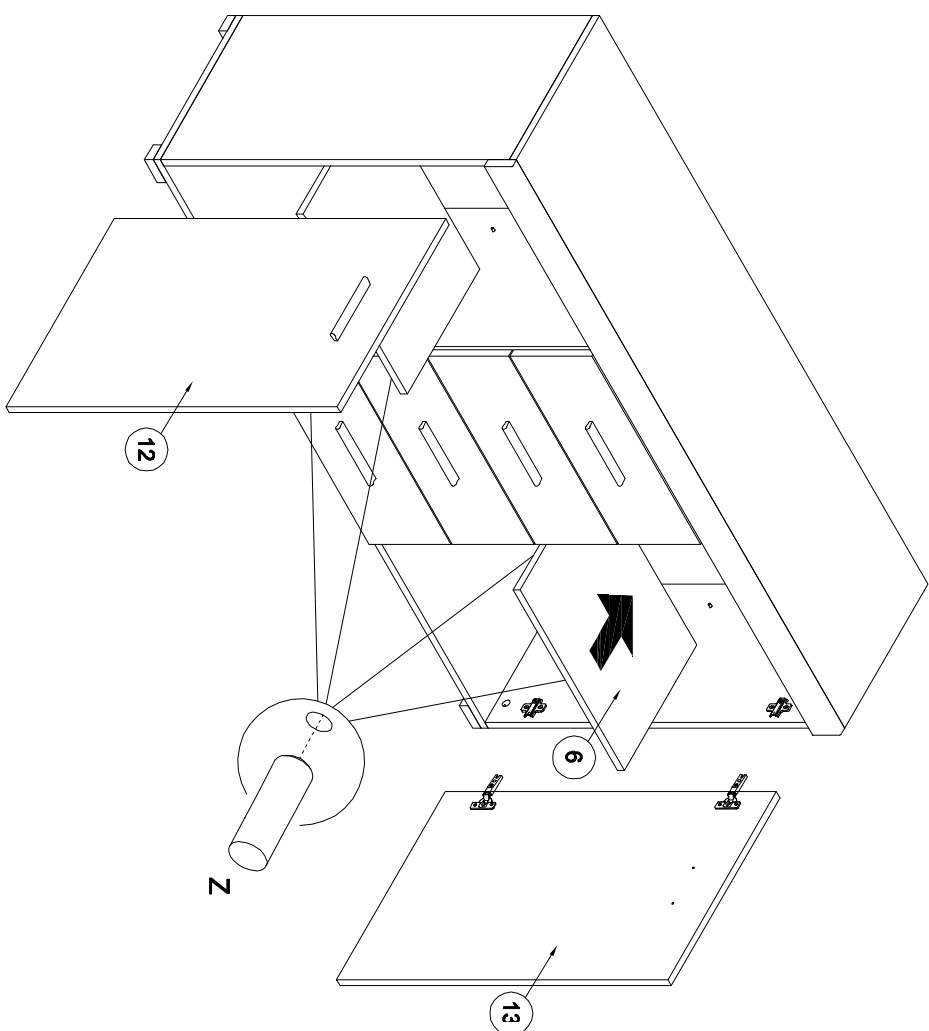

Z

x8