

# FALCO

## FRTV150

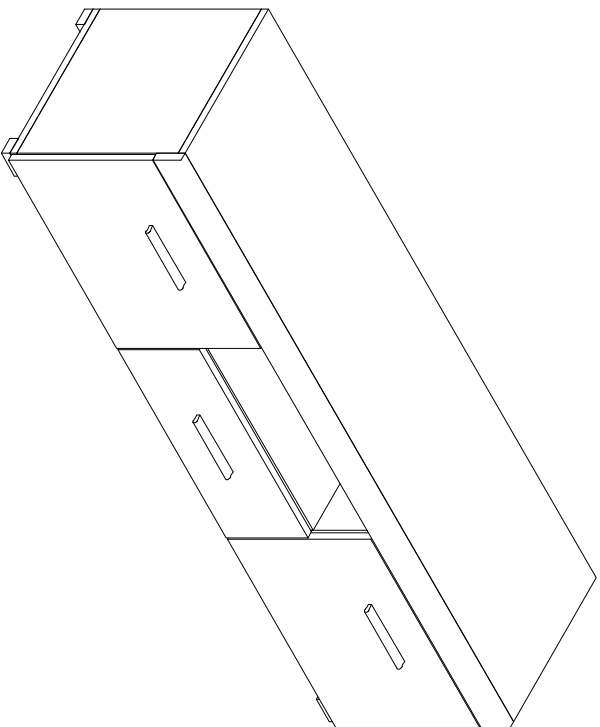

25.6.2017

- (D)** Montageanleitung
- (FR)** Notice de montage
- (NL)** Handleiding voor de montage
- (CZ)** Montážní návod
- (HU)** Szerelési útmutató
- (TR)** Montaj talimatı
- (GB)** Assembly Instructions
- (IT)** Istruzioni di montaggio
- (PL)** Instrukcja montażu
- (SK)** Návod na montáž
- (RO)** Instrucțiunile de montaj
- (RU)** Инструкции по монтажу

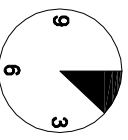
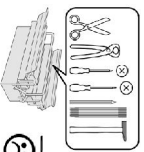

20 min.

1

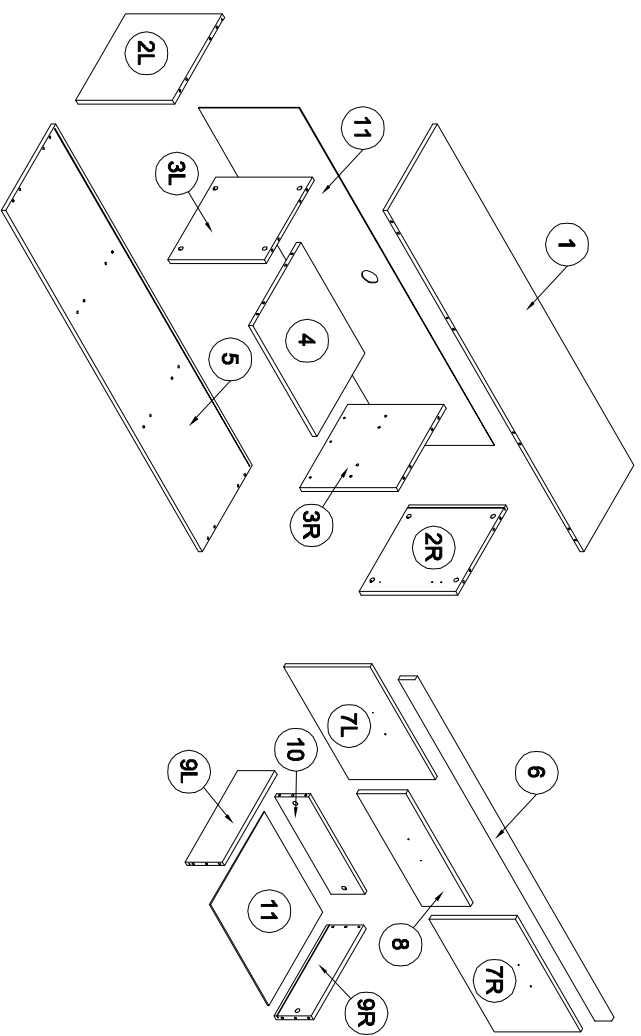

<b>NA</b> 4x13 X8	<b>PC</b> X4	<b>ND</b> 3,5x16 X6	<b>YA</b> 4x27 X6	<b>Z</b> X28	<b>WB</b> 3,5x13 X6	<b>Y</b> X6	<b>RPS</b> X1	<b>RC</b> X4	<b>N</b> 3x20 X12	<b>X</b> X8
<b>B</b> X28	<b>A</b> X32	<b>C</b> X28	<b>W</b> X3	<b>NB</b> 3,5x13 X6	<b>Y</b> X6	<b>RPS</b> X1	<b>RC</b> X4	<b>N</b> 3x20 X12	<b>X</b> X8	

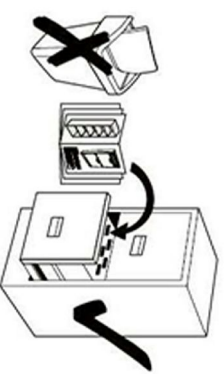
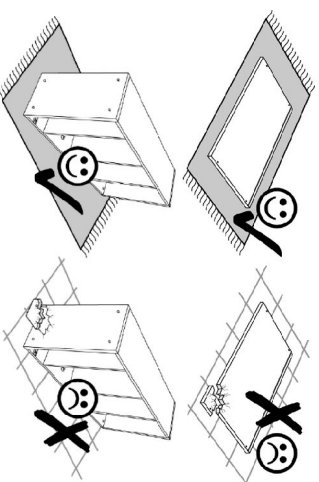

2

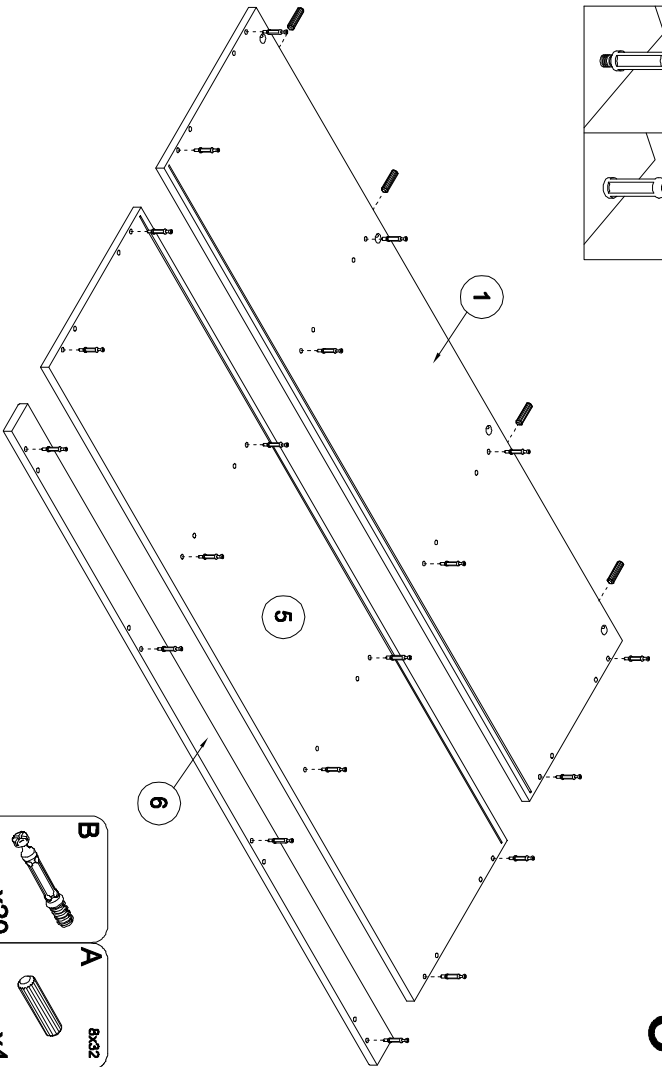
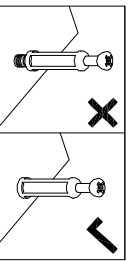

3

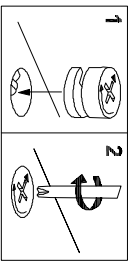
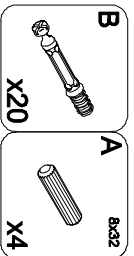

4

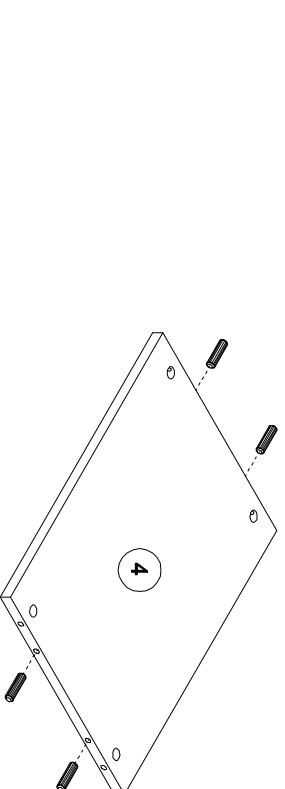
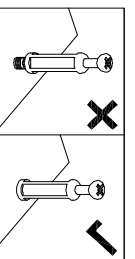

5

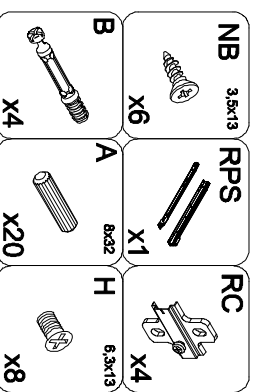
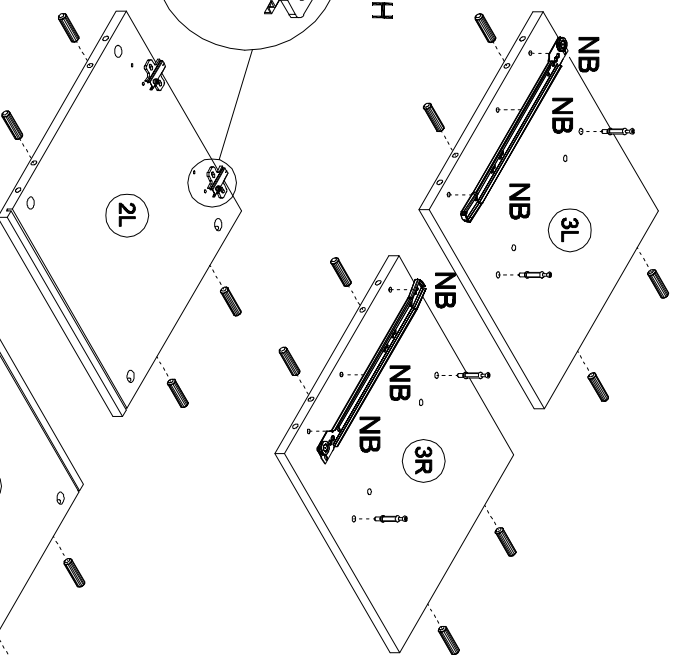
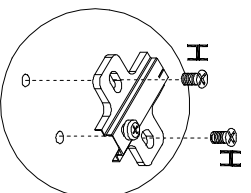

6

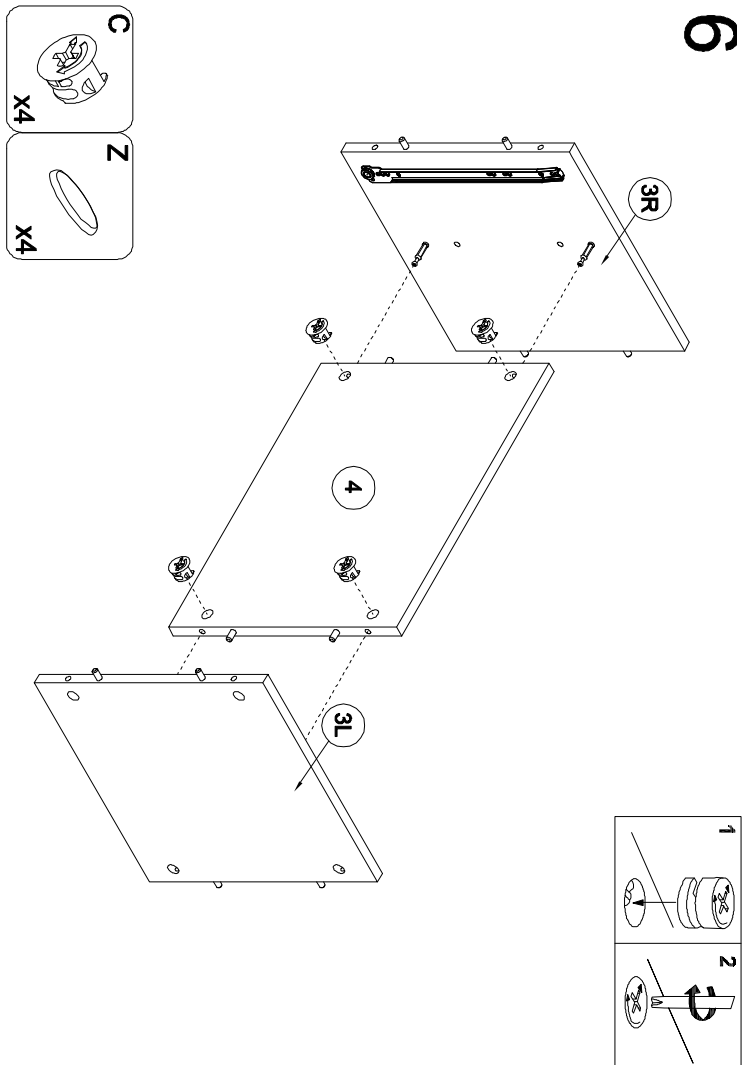

8

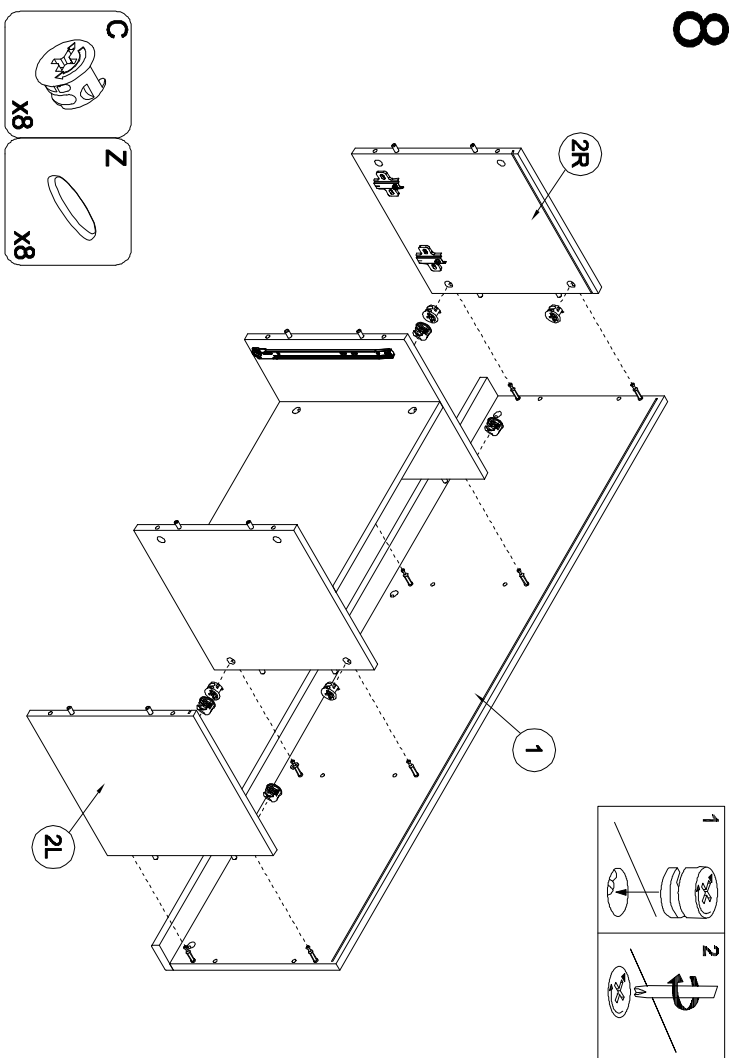

7

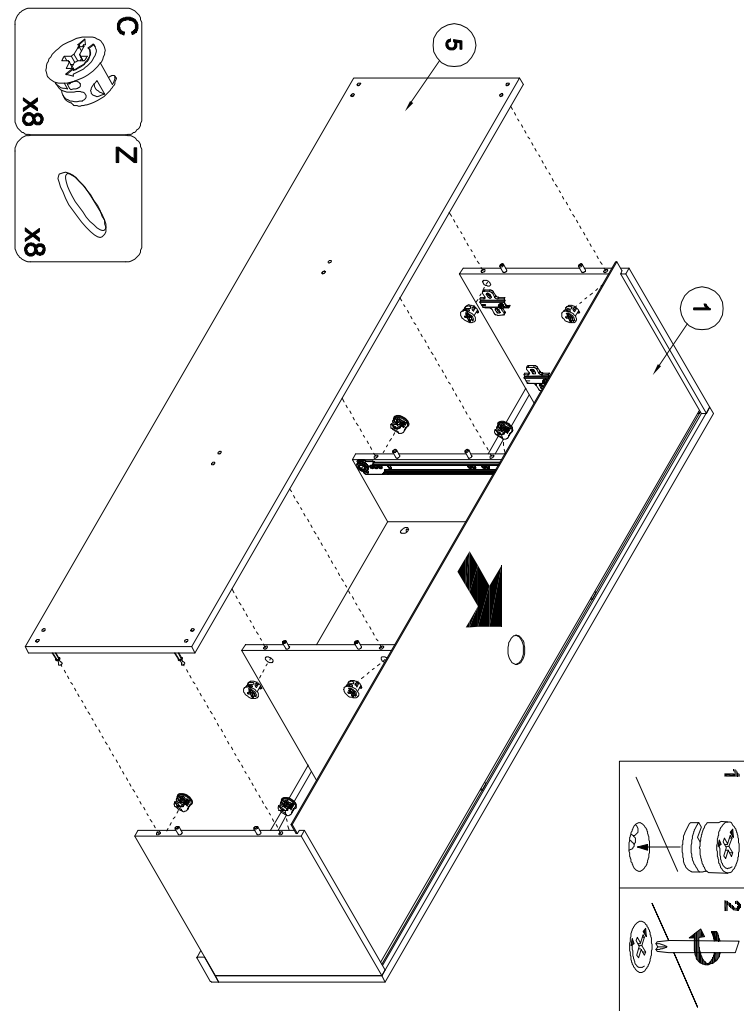

9

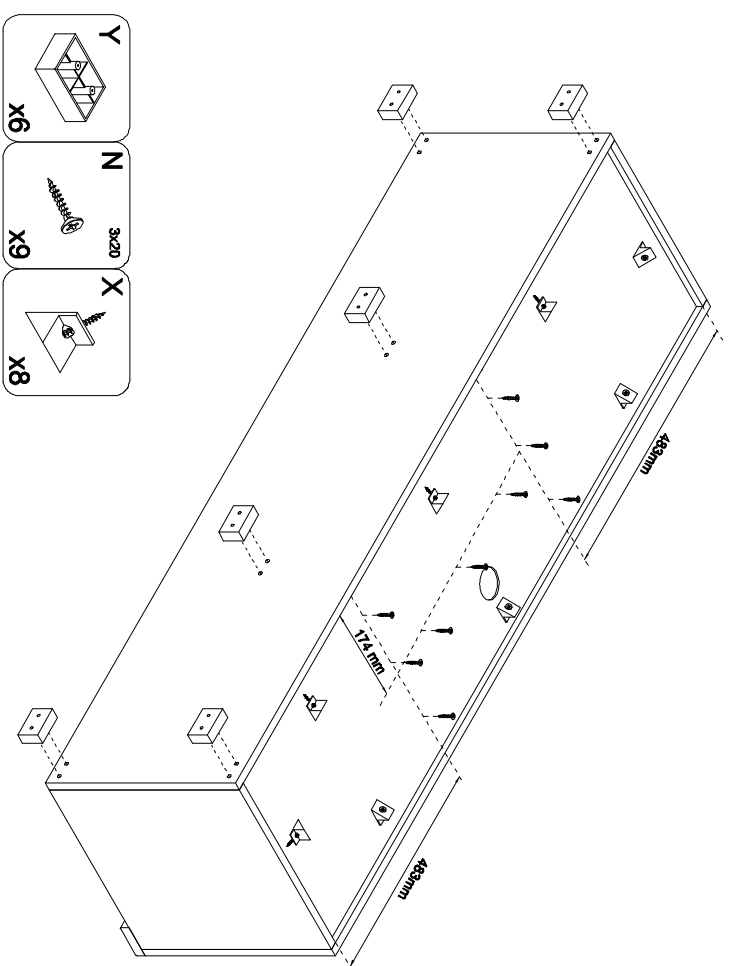

10

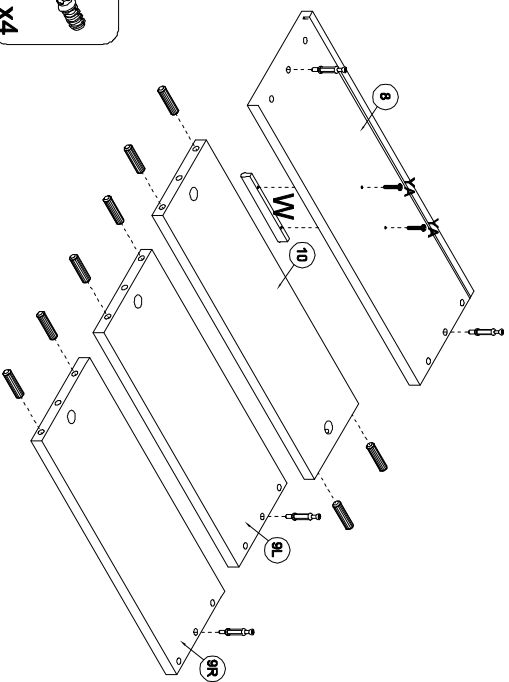

- |                         |                |
|-------------------------|----------------|
| <b>A</b><br>8x32<br>X8  | <b>B</b><br>X4 |
| <b>YA</b><br>4x27<br>X2 | <b>W</b><br>X1 |

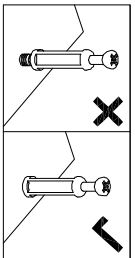

- |                |                |
|----------------|----------------|
| <b>C</b><br>X2 | <b>Z</b><br>X2 |
|----------------|----------------|

11

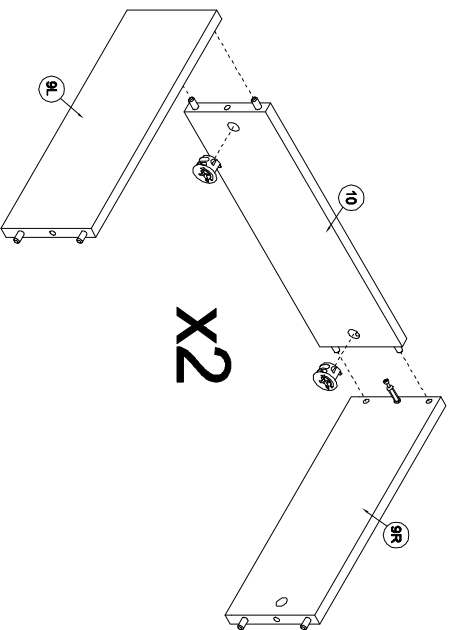

X2

12

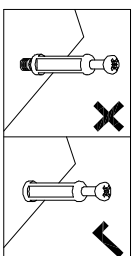
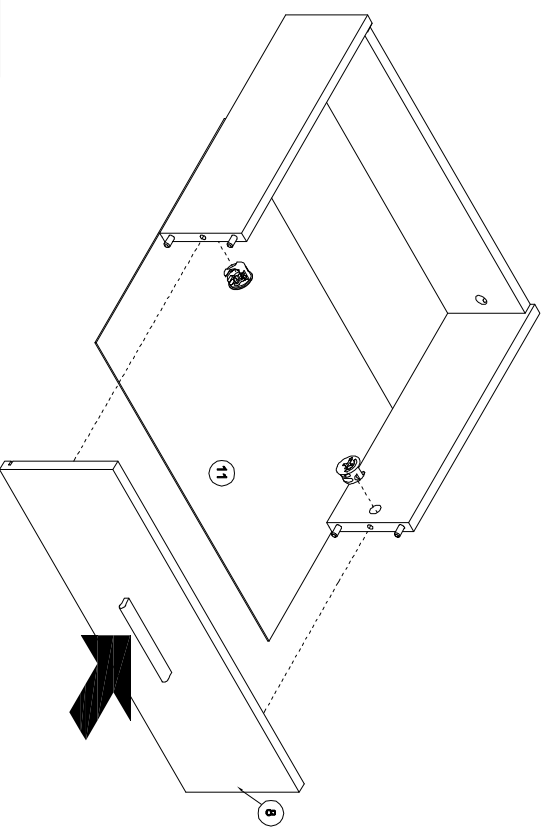



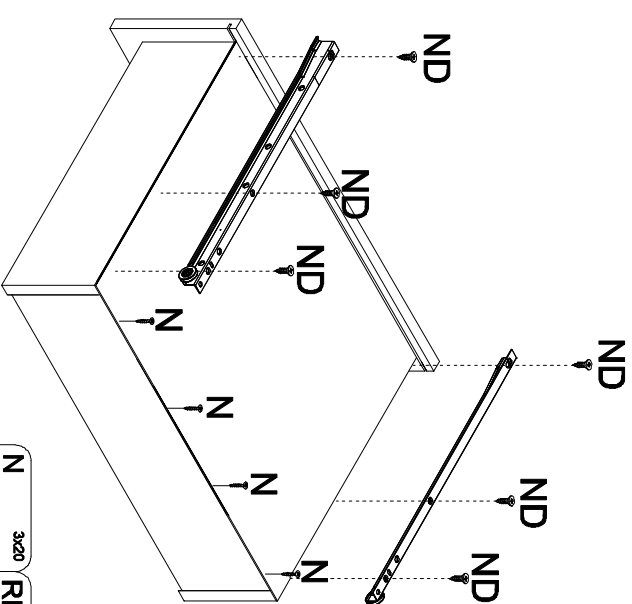

- |                |                |
|----------------|----------------|
| <b>C</b><br>X2 | <b>Z</b><br>X2 |
|----------------|----------------|

13



- |                        |                  |                           |
|------------------------|------------------|---------------------------|
| <b>N</b><br>3x20<br>X4 | <b>RPS</b><br>X1 | <b>ND</b><br>3.5x16<br>X6 |
|------------------------|------------------|---------------------------|

PC	YA	NA
		
X4	X4	X8
	4x27	
		4x13
	W	
		
	X2	

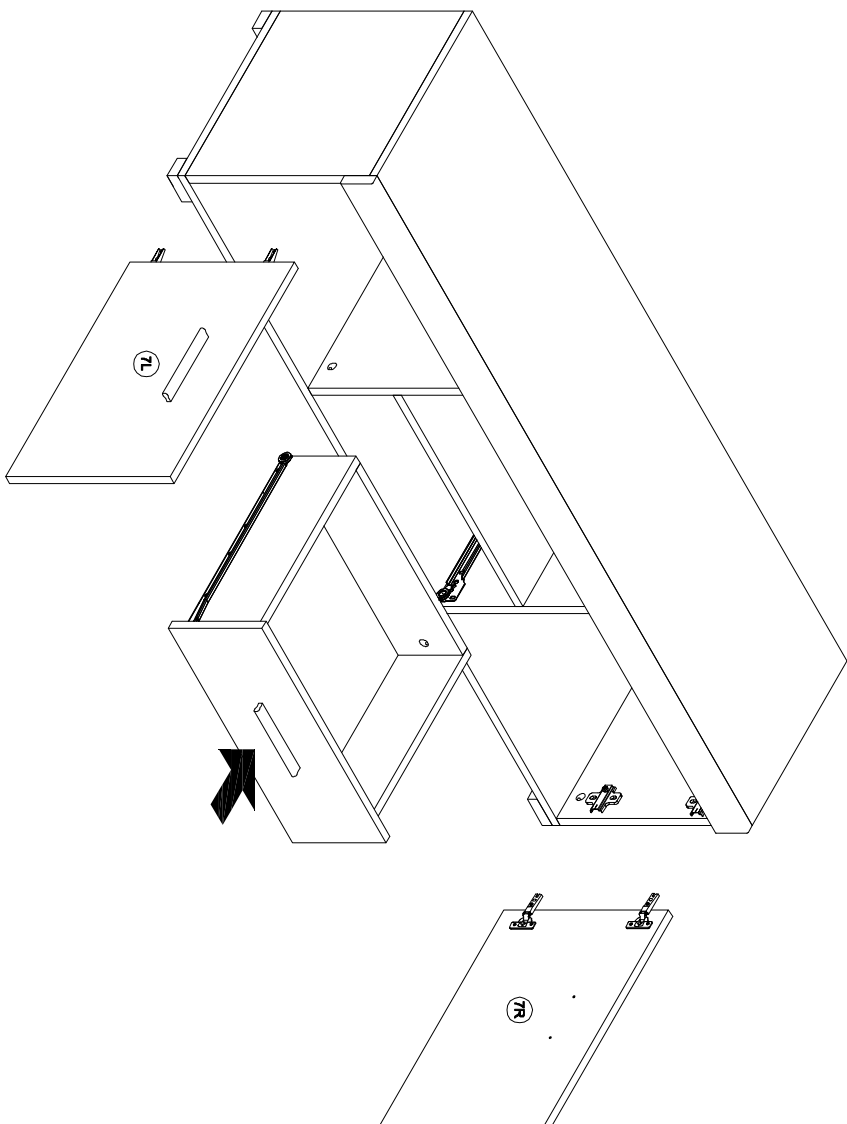
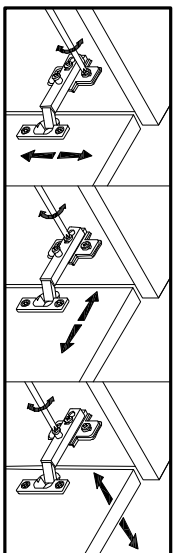
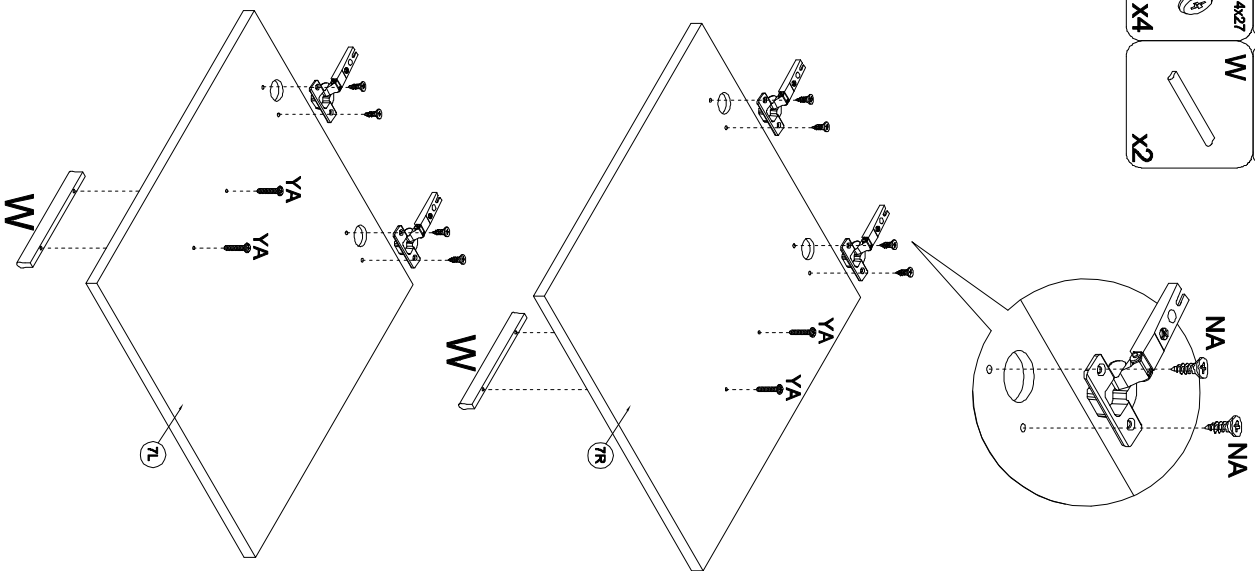

# FALCO

## P100

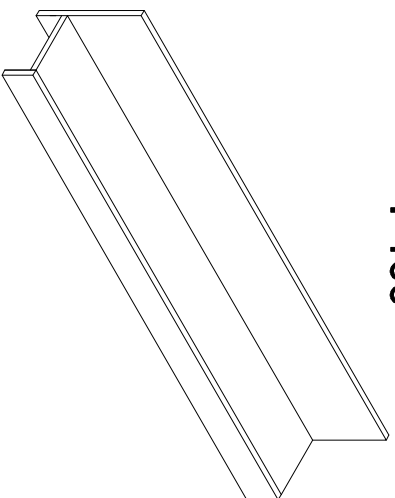

25.5.2017

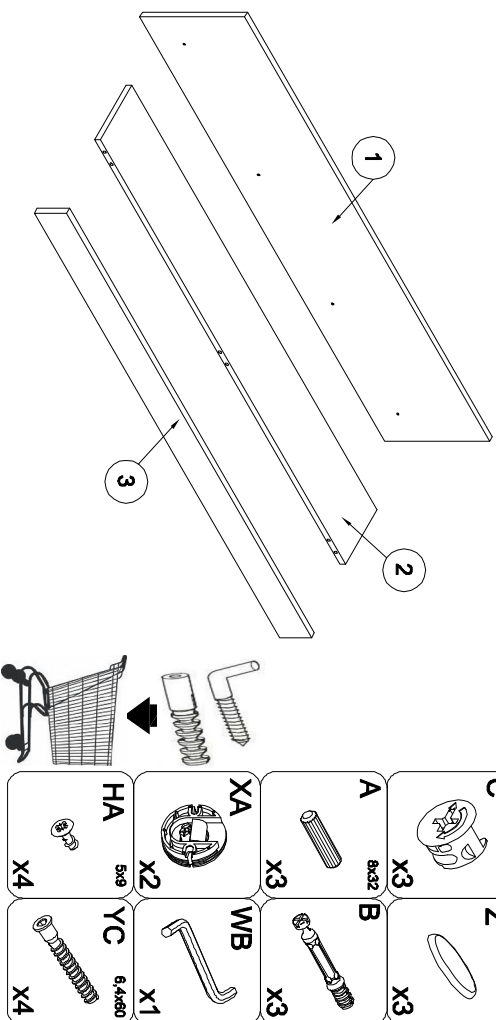

<b>C</b> X3	<b>A</b> 8x32 X3	<b>XA</b> X2	<b>HA</b> 5x8 X4
<b>Z</b> X3	<b>B</b> X3	<b>WB</b> X1	<b>YC</b> 6.4x60 X4

- D** Montageanleitung
- FR** Notice de montage
- NL** Handleiding voor de montage
- CZ** Montážní návod
- HU** Szerelési útmutató
- TR** Montaj talimatı
- GB** Assembly Instructions
- IT** Istruzioni di montaggio
- PL** Instrukcja montażu
- SK** Návod na montáž
- RO** Instrucțiunile de montaj
- RU** Инструкции по монтажу

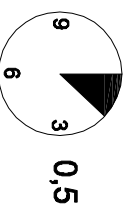
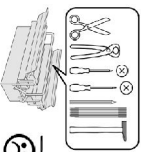

1

2

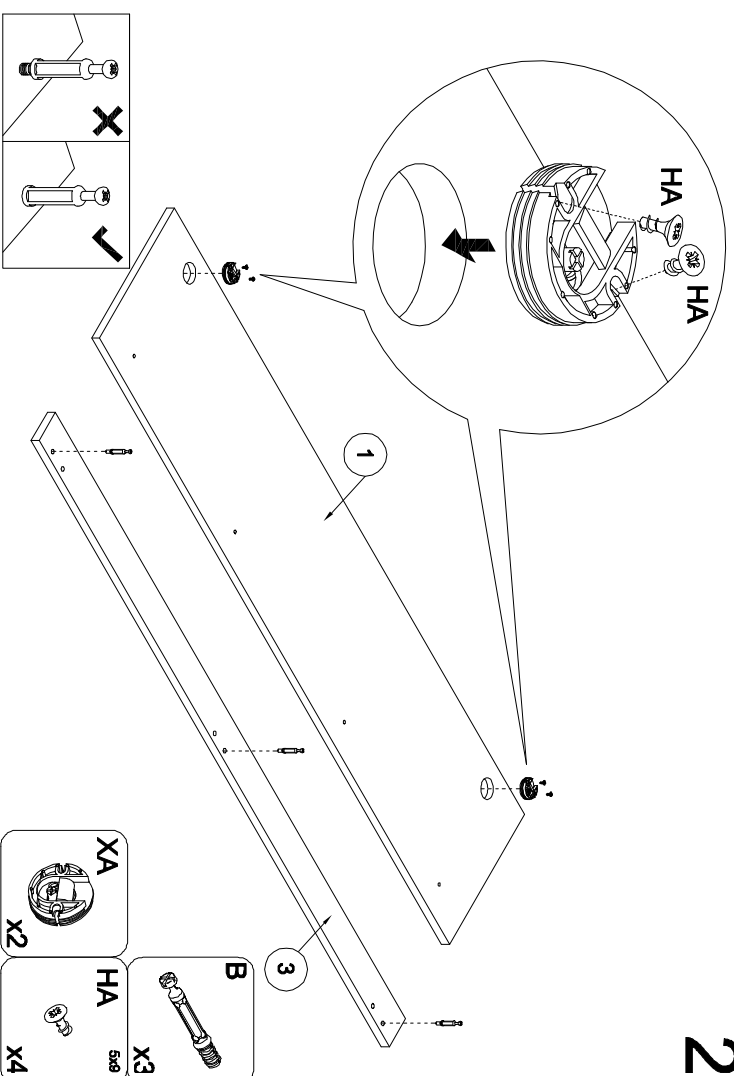

<b>B</b> X3	<b>XA</b> X2
<b>HA</b> 5x8 X4	

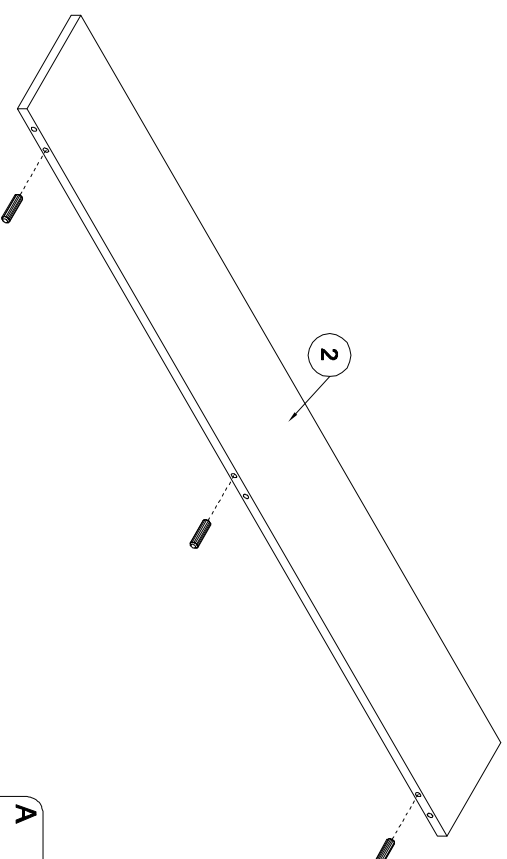

<b>A</b> 8x32 X3
------------------------

3

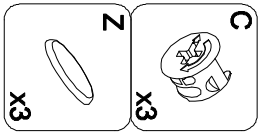
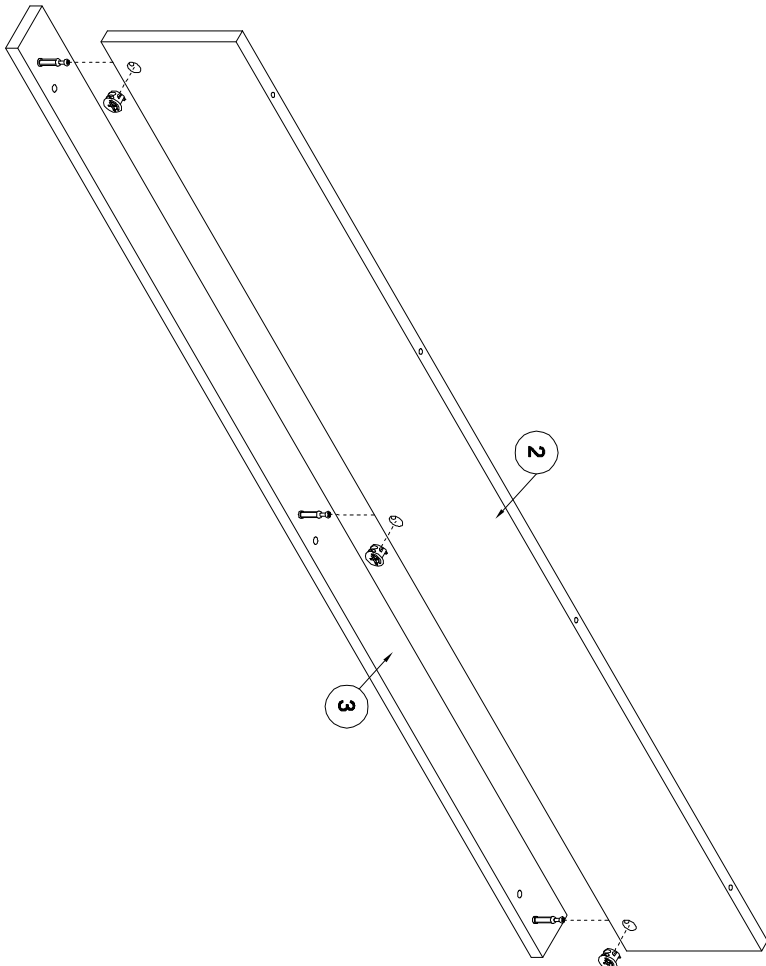
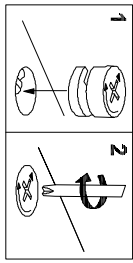

4

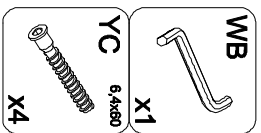
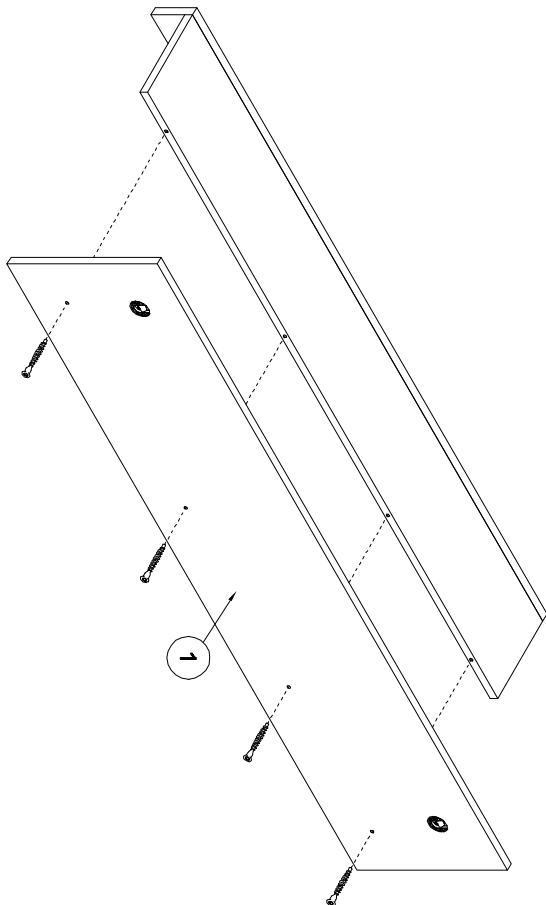

5